

Top View of Assembly

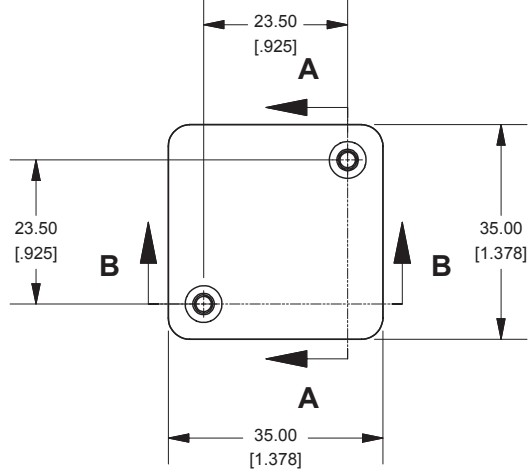

SECTION A-A End View of Assembly

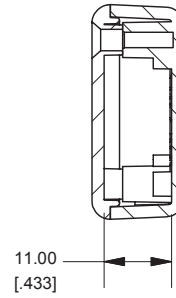

1551N (Basic)

SECTION B-B Side View of Assembly

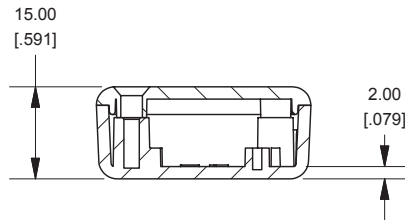

Top View Looking Inside Box

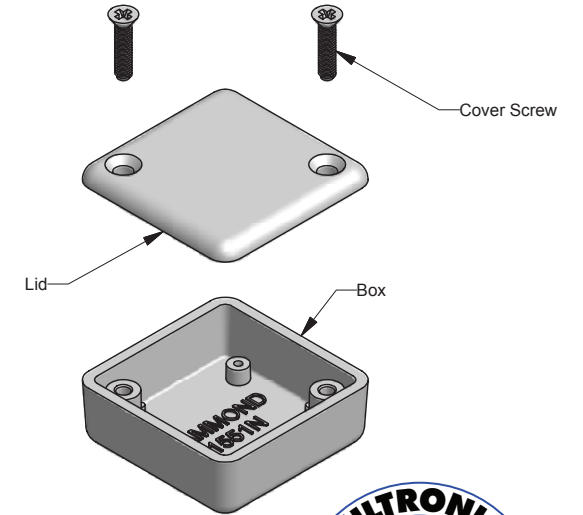
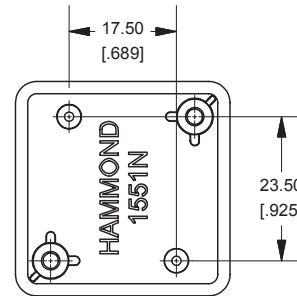

SECTION C-C Boss Heights

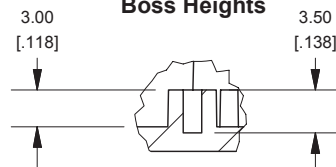

Lid

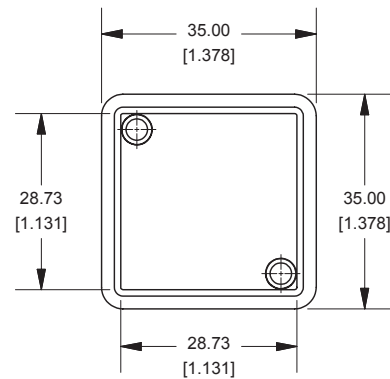

Maximum P.C. Board Size

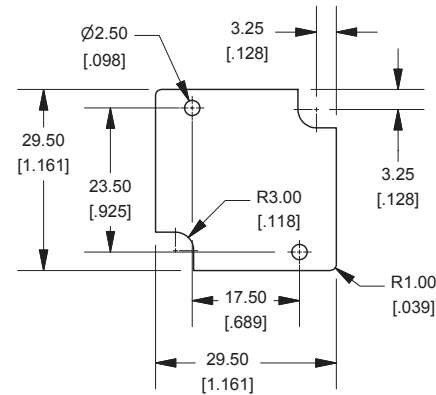

NOTE

Purchased assembly includes lid and box made from GP ABS material and cover screws.

1551N

1551N Enclosure	
Black Enclosure - RAL 7011	1551NBK
Gray Enclosure - RAL 7035	1551NGY
ACCESSORIES	
Black Enclosure Cover Screws (Pkg 100) [#4 X 1/2" Self Tapping]	1591TS100BK
Gray Enclosure Cover Screws (Pkg 100) [#4 X 1/2" Self Tapping]	1591TS100
P.C. Board Screws [#2 X 3/16" Self-Tapping]	1551ATS100 (Pkg 100)

