



# AI Network Video Recorder Installation Manual

Supports models from:



NVR-Q20623

**Thank you for purchasing this Network Video Recorder.**

This install guide covers basic setup, installation and use of your surveillance system.

For detailed technical support and software downloads, visit our Help Centre at: [help.c5k.info](http://help.c5k.info)

**Note:** *This guide references the latest version of the NVR firmware (as of Q4 2021). Some images and instructions may differ depending on firmware version.*



[help.c5k.info](http://help.c5k.info)

Software utilised in this manual was current at the time of manual creation.

For the latest version of surveillance software for PC and Mac systems, please scan the QR code or follow the link to the right.

A brief overview of key software is listed below:

**SmartPSS:** Remote view application for live view, playback and configuration of your surveillance system. For Windows & Mac PCs.

**Smart Player:** Playback exported footage & convert video files for Windows & Mac PCs.

**DMSS:** Mobile surveillance application for iOS & Android



Scan QR code or navigate to: [help.c5k.info/software/software-downloads](http://help.c5k.info/software/software-downloads)

# Table of Contents

<b>1. Pre-Installation</b>	<b>4</b>
1.1 Pre-Installation Safety Information	4
1.2 Connecting your NVR and Cameras	4
1.3 NVR Rear Panel & Setup Diagram	5
<b>2. Installing Cameras</b>	<b>6</b>
2.1 Maximising Camera Effectiveness	6
2.2 Mounting Surveillance Cameras	6
<b>3. NVR and Camera Configuration</b>	<b>8</b>
3.1 First Boot and Startup Wizard	8
3.2 Configuring Surveillance Cameras	13
3.3 Configuring Storage Settings	14
3.4 Display Settings	17
<b>4. Footage Playback</b>	<b>18</b>
4.1 Accessing Stored Footage	18
<b>5. Footage Backup &amp; Viewing</b>	<b>20</b>
5.1 Backup Footage to USB	20
5.2 Viewing Footage on a Computer	21
<b>6. AI Functions</b>	<b>22</b>
6.1 Mounting Surveillance Cameras for AI Functions	23
6.2 AI Live View	25
6.3 Motion Detection & Smart Motion Detection	26
6.4 Tripwire & IVS Setup	27
6.5 Face Detection & Recognition	28
6.6 AI Trigger Actions	31
6.7 Disarming	32
<b>7. AI Search</b>	<b>33</b>
<b>8. Troubleshooting</b>	<b>35</b>

# 1. Pre-Installation

## 1.1 Pre-Installation Safety Information

Before connecting your NVR (network video recorder) or cameras, please ensure the following safe installation guidelines are adhered to.

- Do not place cords from the NVR where they can be pinched or stepped on.
- Do not place heavy objects on cords, or cover cords with rugs or carpet.
- Do not expose the NVR to excessive heat or moisture.
- Leave at least 50mm of space between the NVR and other objects to allow ample air circulation.
- Never immerse any component in water and do not spray cleaners or solvents on the cameras.
- Shut down and unplug the recorder before cleaning. When cleaning, use a damp, lint-free cloth only.
- Service of your NVR or surveillance cameras should only be handled by qualified technicians.

We recommend only using **Surveillance-grade HDDs** with your NVR, such as Seagate Skyhawk or WD Purple. These HDDs are built to handle the heavy workload of 24/7 recording; standard HDDs may encounter performance issues.

## 1.2 Connecting your NVR and Cameras

The following section will detail connecting the NVR and surveillance cameras. It is recommended that cameras and connections are tested before mounting. If there is no image or an error message when first connecting cameras, see **Troubleshooting** in Section 8 in this guide.

Refer to **1.3 NVR Rear Panel & Setup Diagram** for full NVR & system diagrams. Refer to rear panel diagram **Fig 1.1** or your NVRs diagram/dimensions for input and output locations.

1. **Connect the cameras to the NVR:** Using CAT5e/CAT6 LAN cables, connect cameras to the built-in PoE Ports on the back of the NVR. No additional power is required for the cameras.
2. **Connect network switches to the NVR:** Connect any network switches to the LAN ports on the back of the NVR.  
**NOTE:** *Connect to a LAN (Ethernet) port, NOT a PoE port.*
3. **Connect a display:** Using an HDMI or VGA cable, connect a monitor or television (not included).
4. **Connect the mouse:** Connect the USB mouse to the rear USB port, saving the front port for easy USB backup.
5. **Connect to your local network:** Using the included Ethernet patch cable, connect to your switch or router.
6. **Connect NVR power:** Plug in the supplied AC power cord to the rear of the NVR.

Upon activating power, LED lights at the front of the NVR should turn on and the NVR will sound on startup. The NVR will then run your surveillance user interface. Cameras will be detected automatically. This completes a successful first boot of your surveillance system and you may begin configuring surveillance cameras.

# 1.3 NVR Rear Panel & Setup Diagram

**NOTE:** Your NVR (network video recorder) model may differ - a 16 channel NVR is shown below.

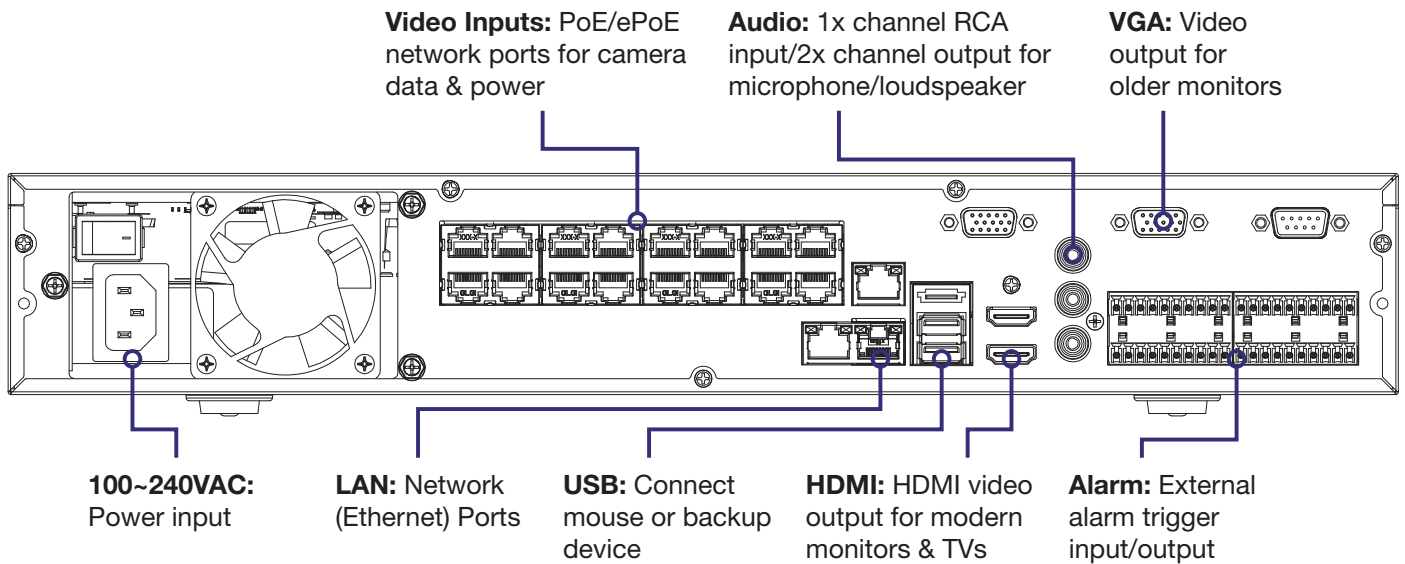

**Fig. 1.1:** NVR Rear Panel Diagram

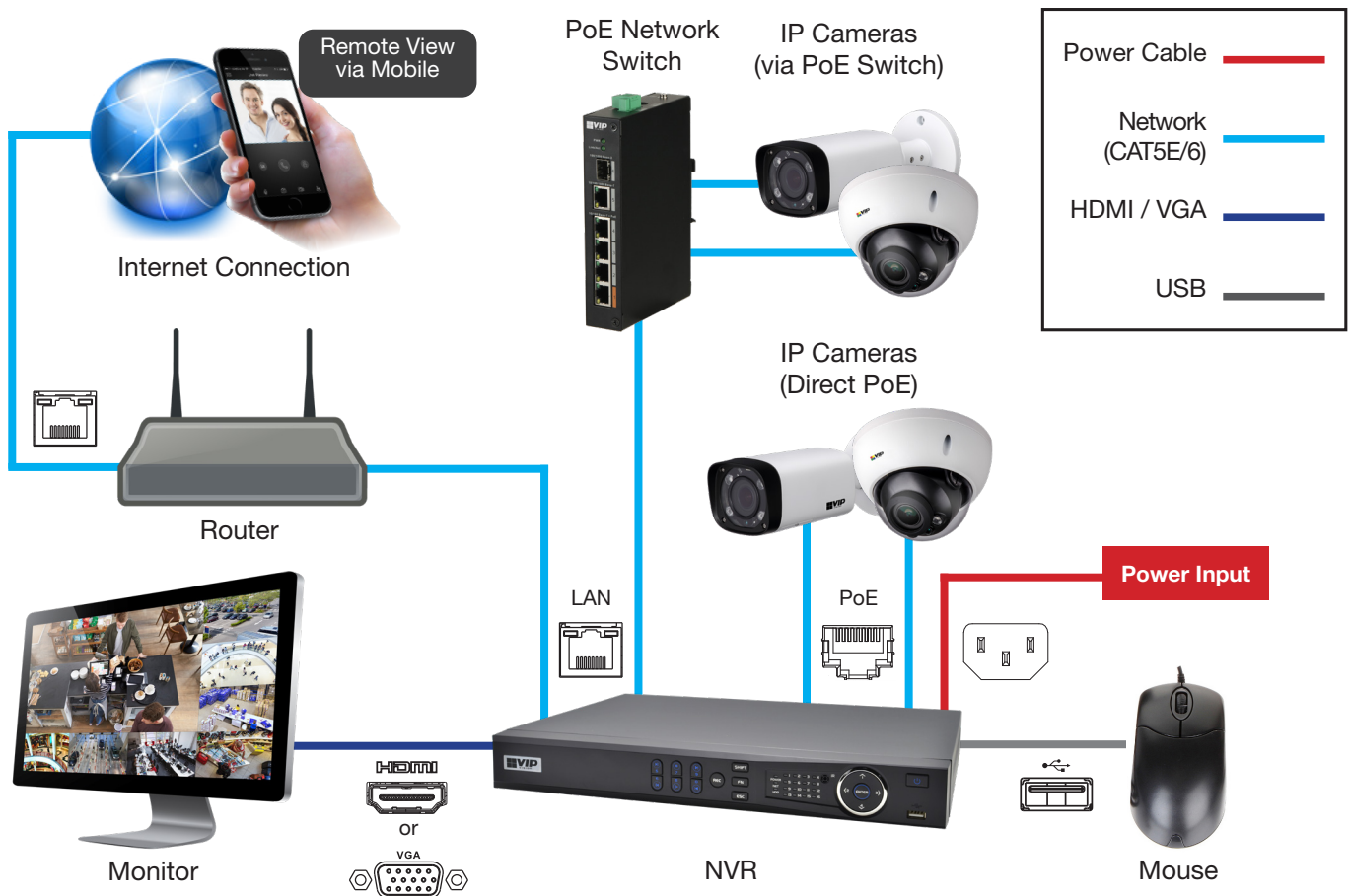

**Fig. 1.2:** System Setup Example

## 2. Installing Cameras

### 2.1 Maximising Camera Effectiveness

To maximise the effectiveness of your surveillance cameras, follow these guidelines for camera mounting.

- **Avoid pointing cameras directly in front of large objects, including walls & eaves.** When infrared turns on at night or in low-light, it may be reflected back into the camera, resulting in an over-bright image.
- Avoid pointing cameras directly at light sources.
- Consider how the sunlight changes during the day. Mount your camera where sunlight has minimum impact.
- Consider your local and state laws before installing your cameras. This may affect where you point your surveillance cameras.
- Avoid direct exposure to weather. If possible, mount under an eave or awning. While the cameras are water-resistant, rain on the lens will affect image quality.
- Ensure the mounting surface thickness can support triple the weight of the camera.
- Do not mount the camera behind glass as this can reduce performance and usability of surveillance in both day & night images.
- Light levels should be approximately the same between the camera and the targeted area.
- Do not place camera or cabling near high voltage wires or other sources of electrical interference.

### 2.2 Mounting Surveillance Cameras

1. Loosen the camera mount assembly by adjusting the locking screw with the included wrench.
2. Mark the screw position on the mounting surface.
3. Drill mounting holes for the wall plugs.
4. Drill a larger hole (approx. Ø10mm) so the camera cable can pass through the mounting surface.
5. Pull the cables through the building walls/ceiling from the camera to the recorder.
6. Connect the camera LAN cables, ensuring your camera is sealed away from rain and dust. Fit the water-proof cable gland (included with camera). If installing in an area where moisture exposure is possible, seal power and video connections with self-amalgamating tape (not included).
7. Affix the camera to the mounting surface using the supplied screws and wall plugs.
8. Reassemble the camera, loosely locking the enclosure using the locking screw and wrench.
9. Connect the LAN cable back to the NVR and view the video feed.
10. Adjust your camera to the desired position.

**NOTE:** To adjust the angle of cameras with tri-axis mounting, simply loosen the locking screw(s) to adjust your camera's position, then tighten again once finished.

## 2.2 Mounting Surveillance Cameras (cont.)

**NOTE:** Diagrams shown below assume camera to be mounted on masonry. Cameras mounted on drywall (gyprock, plasterboard, etc.) will require special mounting screws or toggles (not included).

Diagrams are examples only - screws and other physical components may vary depending on your camera model(s).

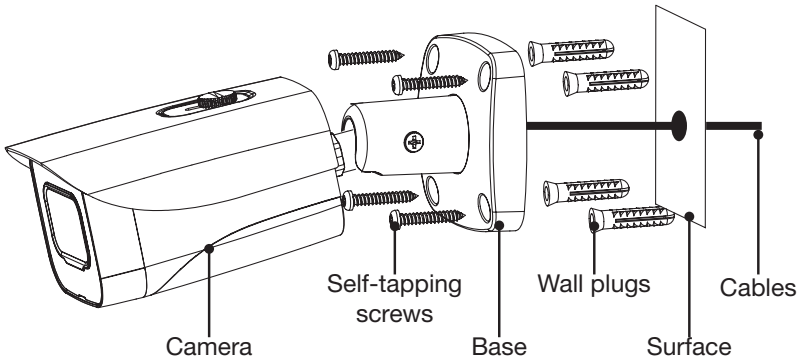

**Fig. 2.1:** Mounting diagram for fixed bullet

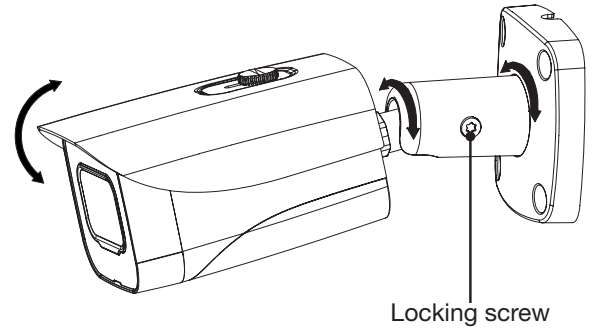

**Fig. 2.2:** Tri-axis fixed bullet adjustment

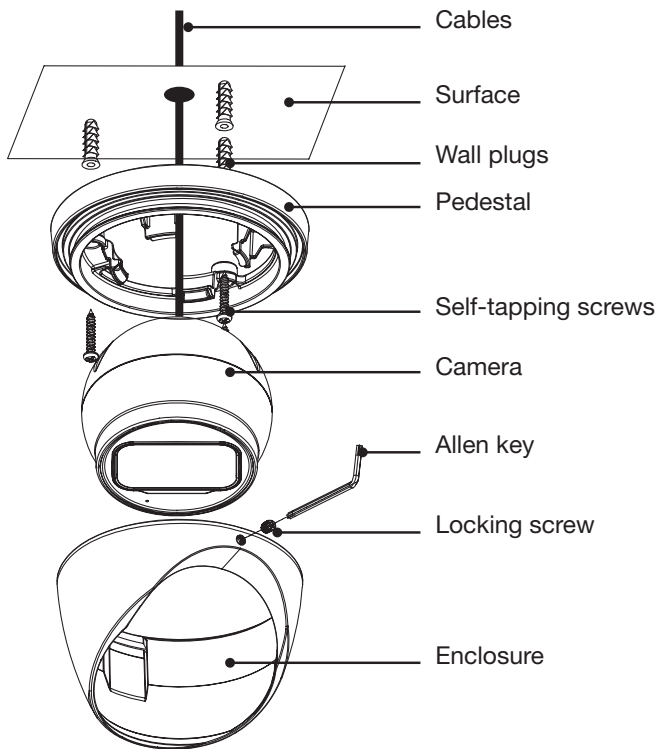

**Fig. 2.3:** Mounting diagram for fixed dome

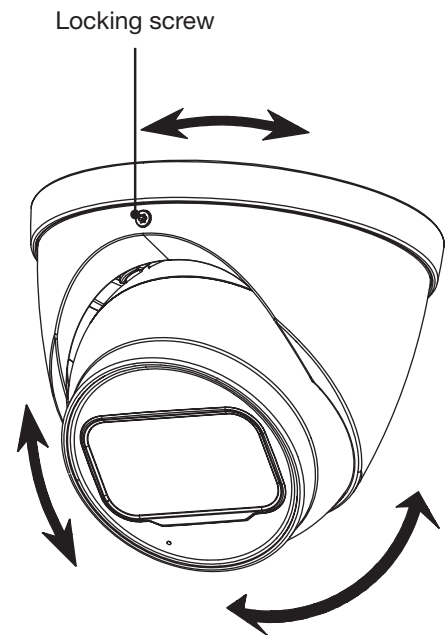

**Fig. 2.4:** Tri-axis fixed dome adjustment

## 3. NVR and Camera Configuration

### 3.1 First Boot and Startup Wizard

After successful connection and boot of your NVR, you will be taken through first-time setup for your surveillance system. Here you will configure system security and begin customising your NVR, including setting camera encoding options, network setup and remote view configuration. **USB keyboards are supported, but not required;** an on-screen keyboard will appear when needed.

**NOTE:** Each setting shown in the Startup Wizard can be modified later via the NVR Main Menu. See the Menu Quick Guide in Section 6 or see the full user manual for more information.

Following the prompts, complete each section in the Startup Wizard, as detailed below:

#### 3.1.1 Startup Wizard

When the NVR is powered up for the first time or the NVR is restored to factory settings, the Startup Wizard will be displayed. Users can set common NVR functions by following the procedures step-by-step

#### 3.1.2 Device Initialization

The first step of the Startup Wizard is Device Initialization. Here you can confirm the basic settings of your NVR such as region, language, video standard, date, time and automatic updates.

Default settings are adequate to get started, we recommend checking the following:

1. Set your **Region, Time Zone** and **System Time**.
2. Users in NSW, VIC, SA, TAS and ACT will need to enable **DST** (Daylight Saving Time). Adjust **Start Time & End Time** settings.
3. Enable the **Online Update** setting to be notified whenever a new firmware update is available. For compatibility with future cameras and to receive security updates, we recommend this setting to be turned on.

**NOTE:** Daylight Saving Time begins at 2am on the first Sunday in October, when clocks are put forward one hour. It ends at 2am (which is 3am Daylight Saving Time) on the first Sunday in April, when clocks are put back one hour.

**NOTE:** **Online Updates** requires an internet connection.

The screenshot shows the 'Device Initialization' screen with the following settings:

Region	Australia
Language	English
Video Standard	PAL
Time Zone	(UTC+10:00) Canberra, Melbourne, Sydney
System Time	2021 -08 -30 13 : 27 : 50
DST	<input checked="" type="checkbox"/>
Type	<input type="radio"/> Date <input checked="" type="radio"/> Week
Start Time	Oct 1st Sun 02:00
End Time	Apr 1st Sun 03:00
Online Update	<input checked="" type="checkbox"/>

Fig. 3.1: Device Initialization Screen



## 3.1 First Boot and Startup Wizard (continued)

### 3.1.3 Securing your NVR

In the Startup Wizard, you will be prompted the setup the **admin account**.

1. Enter a strong **password** to be used for the **admin** account. It is recommended to use a combination of letters, numbers and symbols.
2. (Recommended) Enter a **Password Hint**.
3. Click **Next**.
4. (Optional) Draw an **Unlock Pattern** for quick unlocking or click **Skip**.
5. (Recommended) Enter an **Email Address** to be used for password resets.
6. (Recommended) Select three **Security Questions**, then enter the three Answers. This will be used if the admin password is forgotten. Please note that answers are **case-sensitive**.

**NOTE:** Email address password resets require a mobile phone with the DMSS app & internet access.

**NOTE:** We strongly recommend setting up email password reset and security questions. If the password is forgotten and no recovery method is set up, the recorder will need to be sent back to the supplier for a system reset, which will incur a fee even if the system is still within the warranty period.

### 3.1.4 Configuring TCP/IP, P2P, and Remote View

Network setup will be prompted next, enabling you to connect your DVR to the Internet. First ensure that your DVR is connected to your switch or router via the included CAT5 cable (detailed in Section 1.3). For the simplest setup we recommend using DHCP to connect to the Internet. You will then be prompted to configure P2P for remote view on your internet connected phone or tablet.

1. In the **Network** section, select **modify**  next to **nic1**.
2. Turn on **DHCP**, then click **OK**.
3. Click **Next** to continue.
4. Enable **P2P** to enable remote access.
5. **P2P Status** should read **Online**. This indicates an active internet connection. (This may take a few minutes).

Fig. 3.2: Password Setting screen

Fig. 3.3: Unlock Pattern screen

Fig. 3.4: Password Protection screen

Fig. 3.5: NIC1 Modify Page (example only)

Fig. 3.6: P2P Setup Page (example only)

## 3.1 First Boot and Startup Wizard (cont.)

### Remote View: Adding NVR via QR Code

The following details remote view configuration via the **DMSS app** (Apple iOS / Android) on your device. Depending on the device or app version, menus may function or appear slightly different to those explained below.

1. Go to the **Home** screen.
2. To add your NVR by QR Code, select the **+** **Button** and then select **SN/Scan**.
3. Scan the **Device SN** QR code that you see in the P2P section (Fig. 3.5).
4. Optionally, select **Manually Enter SN** to type in the device SN (serial number) to manually add device.
5. Select the **Device Type** as NVR.
6. Choose a name for your NVR in **Device Name**.
7. Enter the **Username** and **Password** for your NVR. The default username is **admin** and the password is what was set in **Section 3.1.3**
8. Tap **Save**.

### Remote View: Enabling Push Notifications

After adding your Recorder to your iOS / Android device, the next step is to enable notifications. This will allow you to receive & respond to surveillance app alerts on your device.

1. Go to the **Home** screen.
2. Select the **...** **Button** on the device to add push notifications for.
3. Select **Device Details**.
4. Tap on **Notification** or **Multi-channel Alarm Subscription**.
5. Toggle Alarm Notifications to **ON (blue)**.
6. Tap on the notifications you wish to receive and enable them. E.g. To enable notifications for Low HDD Space: Tap Disk Alarm, then enable Low Space.
7. Tap **Save**.

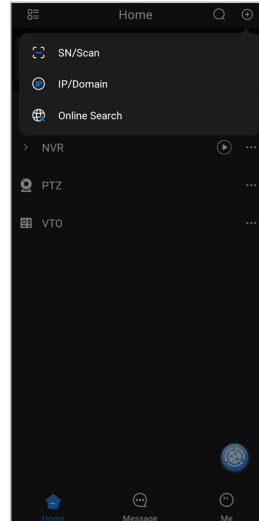

Fig. 3.7a: Home Screen

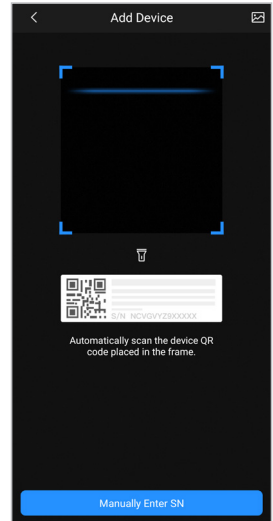

Fig. 3.7b: QR Scan

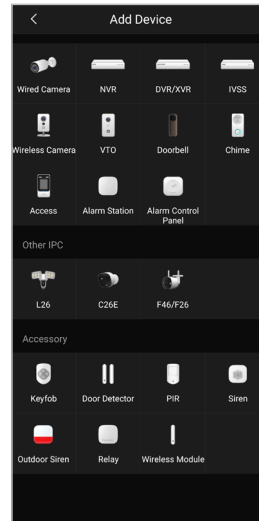

Fig. 3.7c: Device Selection

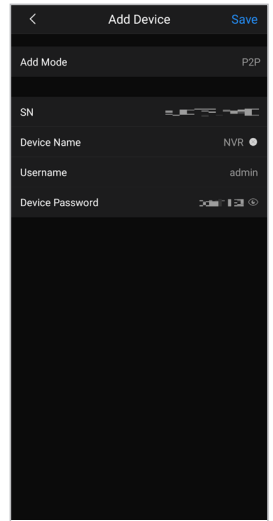

Fig. 3.7d: Add Device

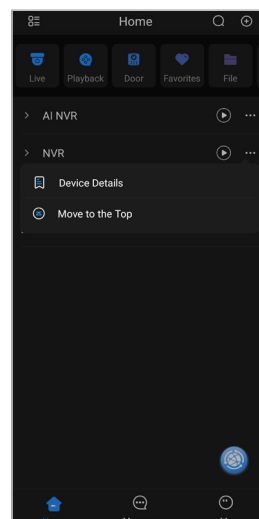

Fig. 3.7e: Device Details

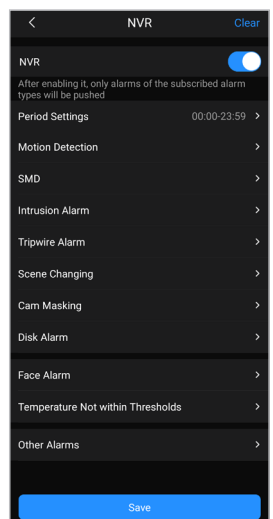

Fig. 3.7f: Alarm Notification

## 3.1 First Boot and Startup Wizard (cont.)

### 3.1.5 Configuring Surveillance Cameras

After configuring remote view, the Startup Wizard will take you to the Camera List menu. This menu will display all detected cameras. Users can also add cameras manually, and setup cameras over the network.

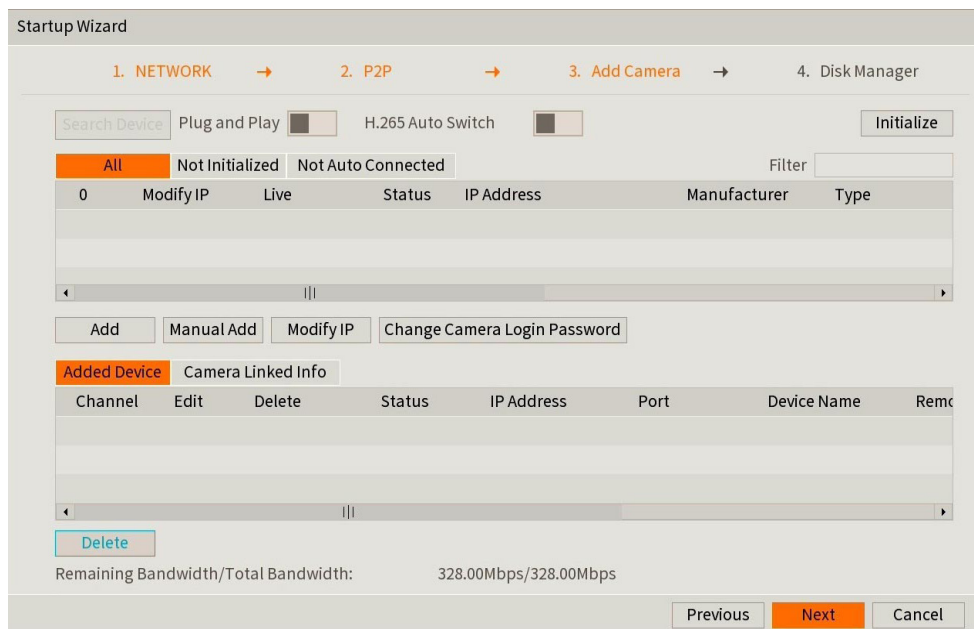

Fig. 3.8: Add Camera Setup page

#### Option 1: Adding Cameras that are connected via the POE Ports on the back of the NVR

Cameras plugged into the POE ports on the back of the NVR should be detected automatically. They will appear in the second table with a **Green** status icon to indicate that the cameras are online. If the status is **Red**, or the camera does not appear in the list, refer to [8.0 Troubleshooting](#).

#### Option 2: Initialising and Manually Addressing Cameras from the Network (POE Switch, Bridge, etc).

1. Select **Device Search**.
2. Tick every camera that you wish to initialise, then click the **Initialize** button.
3. You will be brought to an **Enter Password** screen. Tick **Using current device password and email info**, then click **Next**.
4. Enter the **IP Address**, **Subnet Mask** and **Default Gateway**, then click Next. (NOTE: When initialising more than one camera, the last section of the IP address will be incremented by the Incremental Value.
5. Click **Finished** once all of the cameras have been initialised and addressed.
6. Click **Device Search**.
7. Tick the **checkbox** next to the newly initialised & addressed camera, then click the **Add** button. The camera will appear in the second table with a **Green** status icon to indicate that it is online.

#### Option 3: Manually add a Camera from the network with a known IP Address and Password

1. Click the **Manual Add** Button
2. Set **Manufacturer** to Private (If the camera is a 3<sup>rd</sup> party camera select ONVIF).
3. Enter the **IP Address**, **Username** and **Password** of the camera. (NOTE: The Camera's IP Address must be in the same range as the NVR's LAN port set in 3.1.4)
4. Click **OK** to add the camera. It will appear in the second table with a **Green** status icon to indicate that it is online.

## 3.1 First Boot and Startup Wizard (cont.)

### 3.1.6 HDD Formatting

If your recorder is fitted with a HDD, ensure it is listed on screen, and the health status is normal. Select OK to finish the setup wizard.



Fig. 3.9: Add Camera Setup page



Fig. 3.10: Switch Resolution prompt

### 3.1.7 Switch Resolution Prompt

After exiting the Startup Wizard, the NVR may prompt you to switch your resolution if it detects that the monitor can support a higher resolution than the one currently in use. Select OK to use the new resolution. If it is 4K, the NVR will reboot. For more display options or to update the resolution later, see section [3.4 Display Settings](#).

### 3.1.8 Completed Setup

Startup setup is complete. Below is an example of a **View 8 Liveview** setup. Before mounting cameras, familiarise yourself with the user interface and menu layout.

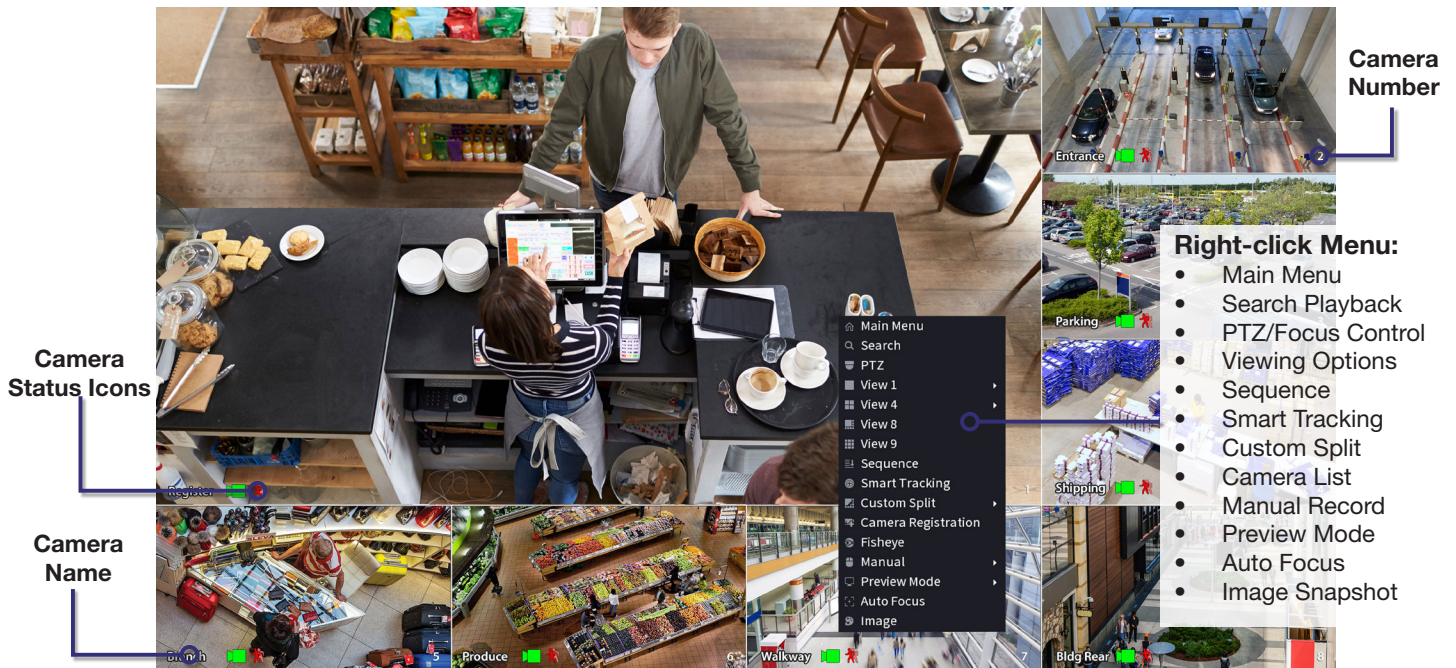

Fig. 3.11: View 8 Liveview screen with right-click menu open.

### Liveview Controls

- **Double-click** on a camera window to make it full-screen; double-click again to return to normal view.
- **Right-click** to access the right-click menu.
- From the right-click menu, click **Main Menu** to access most configuration settings.

### Main Menu Controls

- **Mouse wheel scroll** to view more menu options.
- **Left-click** to enter a menu.
- **Right-click** to return to the Main Menu / return to the Liveview screen from the Main Menu.

## 3.2 Configuring Surveillance Cameras

### 3.2.1 Camera Quality & Bit Rate

After the Startup Wizard has been completed, you can make adjustments to the camera settings via the **Encode** menu. From the **Main Menu** go to the **Management** section at the bottom and click **Camera**.

Each camera features a **Main Stream** for high quality streaming to the NVR; and a **Sub Stream** for low quality, low data streaming to your remote view phone or tablet. You can configure both of these streams for **each individual camera**, so you can choose to prioritise quality for important cameras and recording time for others.

- If the camera has a built-in microphone, select **More**, then enable **Audio**.

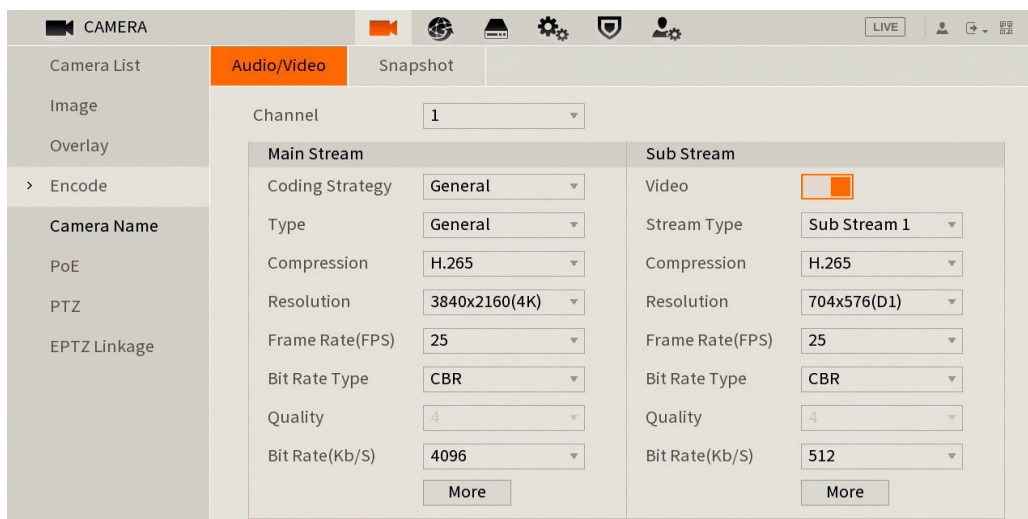

**Fig. 3.12:** Example encode settings for channel 1 (Quality Optimised 8MP, H.265 system)

#### Encode Settings Explained

**Coding Strategy:** The encoding strategy used by the camera. **AI Codec** reduces the amount of storage space utilised while maintaining image quality for key targets. It does this by reducing the bit rate of the camera and using AI to allocate the bit rate to humans and vehicles instead of the background of the image. **Smart Codec** reduces the bit rate for non-important video to conserve storage space. *It is recommended to use **AI Codec** if available and **General** if not.*

**Type:** This dropdown menu switches between encode settings for General, Motion and Alarm recording. Different encode settings can be separately set for each type of recording mode (Standard camera streams will use General settings, while camera streams with Motion Detection enabled will use Motion settings).

**Compression:** The compression technology used when encoding footage for storage on a hard drive. H.265 is the most efficient at compressing footage for storage on your hard drive and will provide the most total record time. **H.265 is recommended for *Main Stream*, H.264 for *Sub Stream*.**

**Resolution:** The camera's image resolution; dictates the size of captured images. A high set resolution means larger pictures captured by the camera each frame, which means higher required bit rate & hard drive storage capacity. *It is recommended to set the **Resolution** as the **highest value** for *Main Stream* and **D1** for *Sub Stream*.*

**Frame Rate (FPS):** Frames per second, or, the number of images that make up each second of video captured by the camera. A high frame rate means more data per second is captured by the camera and sent to the recorder, this requires a higher set bit rate & hard drive storage capacity.

**Bit Rate:** The rate at which video data travels from the camera to the recorder, measured in Kilobits per second. This directly determines the quality of the video stream and how much capacity footage will occupy on the hard drive. *It is recommended to leave this as the **default** value for **optimised quality**, or **2048** for **optimised recording time**.*

**Bit Rate Type:** How bit rate is controlled. By setting **CBR (constant bit rate)**, the camera bit rate is pre-defined and camera quality is constant no matter what is being captured. By setting **VBR (variable bit rate)**, the camera uses a low bit rate when there is little scene activity and switches to a high bit rate when there is more activity. CBR ensures constant quality, whilst VBR conserves hard drive capacity in times of low activity. *It is recommended to set this to **CBR** for **optimised quality** or when using **AI Codec**, or **VBR** for **optimised recording time**.*

## 3.2 Configuring Surveillance Cameras (cont.)

### Optimised Encode Settings

Fig. 3.13 details quality optimised values and max. recording-time optimised values for 4K cameras. Values will vary by camera model.

Field	Quality Optimised		Recording Time Optimised	
	Main Stream	Sub Stream	Main Stream	Sub Stream
Coding Strategy	AI Codec	-	AI Codec	-
Resolution	3840 * 2160	720 * 576	3840 * 2160	720 * 576
Frame Rate	15fps	15fps	15fps	15fps
Bit Rate Type	-	CBR	-	VBR
Bit Rate	8192Kbps	1024Kbps	2048Kbps	512Kbps

Fig. 3.13: Suggested camera encode values to be set for 8MP cameras.

## 3.3 Configuring Storage Settings

### 3.3.1 Configuring Basic Storage Settings

To make adjustments to the basic storage settings navigate to **Main Menu** -> **Management-Storage** -> **Schedule**.

Here, you can configure the settings for situations when the HDD is full, file size/time length of recorded video, and the settings for auto-deleting old files.

- **Disk Full:** Configure the settings for when all the read/write discs are full, and there is no more free disc. *It is recommended to leave this as the default **Overwrite**.*
- **Create Video Files:** Configure the time length and file length for each recorded video.
- **Delete Expired Files:** Configure whether to delete the old files or not. If yes, also determines how many days of footage are deleted. *It is recommended to leave this as the default **Never**.*
- **Sleep Strategy:** Configure whether the system will sleep automatically after idling for a period of time, or not.

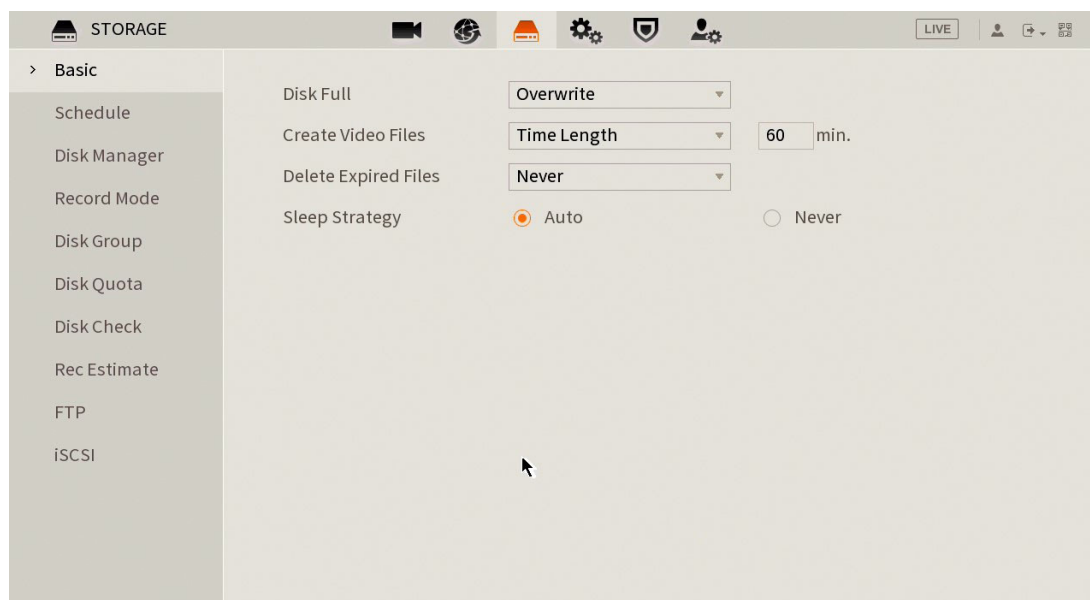

Fig. 3.14: Storage Settings

## 3.3 Configuring Storage Settings (cont.)

### 3.2 Configuring Recording Schedules

To make adjustments to the recording schedule navigate to **Main Menu -> Management-Storage -> Schedule**.

Here you can define the recorded footage schedule in the Record menu (Fig. 3.15), and the recorded image snapshot schedule in the Snapshot menu. By default, cameras are set to non-stop General recording (24 hours a day, 7 days a week).

Schedules can be set in hourly periods for individual days for each camera, with colour-coded options for:

- **General (green)** for all regular recording.
- **Motion (yellow)** for recording on motion detection.
- **Alarm (red)** for recording on triggering an integrated alarm.
- **M&A (orange)** for simultaneous alarm/motion detection recording.
- **Intelligent (blue)** for recording on triggering AI functions such as IVS (Intelligent Video Surveillance), Face Detection, ANPR, People Counting, etc.

The screenshot shows the 'STORAGE' management interface with the 'Record' tab selected. The 'Schedule' section is expanded, showing a 24-hour timeline for each day of the week (Sun through Sat). The 'Channel' is set to 'All', 'Pre-Record' is 4 sec, and 'Redundancy' is 1800 sec. The recording modes are set to 'General' (green), 'Motion' (yellow), and 'Intelligent' (blue). The 'Apply' button is highlighted in orange.

**Fig. 3.15:** Recording Schedule with General, Motion & Intelligent recording set to a 24/7 schedule

#### Setting Motion Detection & Intelligent Recording

1. Click the **Channel** drop down to select **All** cameras.
2. In the days column, toggle the **All** check box to simultaneously set recording schedule parameters for every day of the week.
3. Check the yellow **Motion** check box to select motion detection recording.
4. Click the schedule to fill in areas for motion detection recording. We recommend a 24/7 schedule to mirror your Regular recording schedule (Fig. 2.10).
5. Repeat steps 3 & 4 with the blue **Intelligent** check box to set intelligent recording (tripwire, face detection, etc).
6. Click **Apply** to confirm recording schedule changes. You have now set up motion detection & intelligent recording. This will be beneficial when it comes to searching footage in playback (Section 4.0).

**Note:** For instructions on how to configure MD / IVS etc., see **6.3 Motion Detection** & **6.4 Tripwire & IVS Setup**.

## 3.4 Display Settings

### 3.4.1 Configuring Display Settings

To configure display settings, navigate to **Main Menu** -> **Display**. You may have to scroll to the second page of the Main menu.

- Set the **Resolution** of the **Main Screen** to the resolution of your monitor or television. Be careful not to set this value higher than what your TV/monitor can support or it will be unable to display the NVR.
- Toggle **AI Rule** and **SMD Preview** to show/hide AI rules and previews (IVS, SMD, etc) on the Live View page of the NVR.
- Configure **Live Audio** to toggle which channels have permission to play audio through the TV/Monitor if it has been enabled.

### 3.4.2 Configuring a Second Display

You can configure the VGA or a second HDMI port to display different cameras to a second TV/Monitor.

1. Enable **Sub Screen**.
2. Set the **Output Port**. For NVRs with two HDMI Ports, set this to HDMI 2. For NVRs with one HDMI, set this to VGA.
3. Set the **Resolution** to the resolution of your TV/monitor.
4. Click **Apply**.
5. Exit the **Main Menu**, right-click, then select **Sub Screen**
6. The mouse will move to the other display. Click **OK** on the prompt.
7. **Right-click** then select the **View** you wish to use.
8. **Right-click** then select **Main Screen** to return to the Main Screen, then Click **OK** on the prompt.

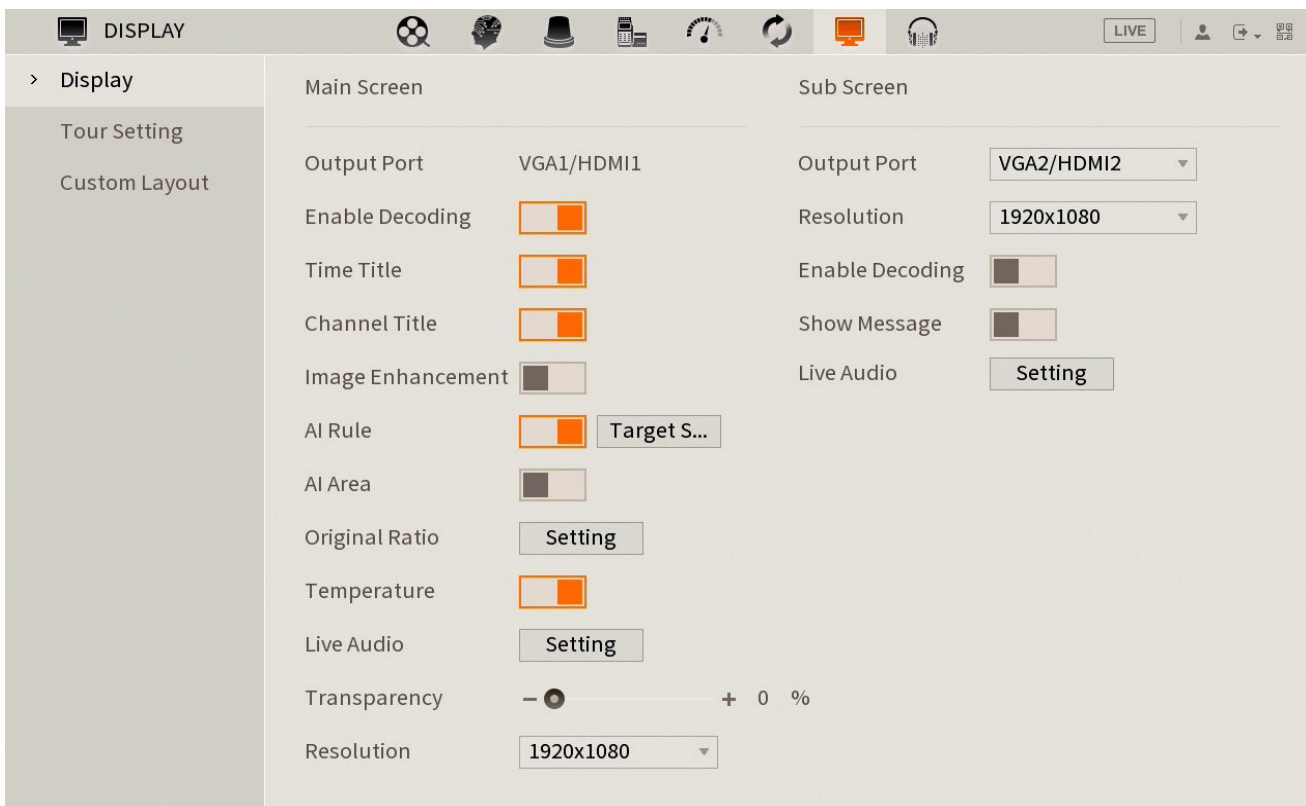

Fig. 3.16: Configuring Display Settings



## 4. Footage Playback

To access footage playback, select the **Search** button from the **Main Menu**. Stored footage can be accessed by searching by date and refined by footage type (General, Motion, Alarm, etc). The below image details the playback interface with footage selected.

After locating the desired footage, you can immediately backup the video by using the search menu. See Section 5.1.1 for more information.

### 4.1.1 Playback Footage by Date

Use Fig. 4.2 on the opposite page as a guide.

1. Ensure that the correct **HDD** is selected and that **REC** checked in **Source Select**.
2. Using the **Date Select** calendar, choose your date for footage playback. A coloured dot icon indicates stored footage is available for that day (Fig. 4.1).

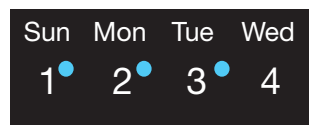

**Fig. 4.1:** Date select Calendar showing footage is available for Sun, Mon, Tue.

3. Select the cameras to be viewed. The screen will automatically split depending on the amount of cameras selected.
4. The **Footage Timeline** should populate with stored footage, indicated by coloured bars in the timeline. Click anywhere on the timeline to begin footage playback. Other cameras will automatically sync their playback to the selected camera.
5. For greater precision playback control, zoom in on areas using the **Timeline Zoom**, up to 30 minutes.
6. Using the **Playback Controls**, you can speed up or slow down playback, place marks on key footage times and take snapshots.

### 4.1.2 Playback Footage by Smart Search

**NOTE:** *Smart search requires motion detection to be recorded to function. You can only Smart Search playback footage one camera at a time. If Smart Search is not functioning, check Section 6 for troubleshooting.*

1. As detailed in the previous section, use **Date Select** to locate your desired date for footage playback, and choose a single camera only in **View Select**.
2. Click anywhere on the Footage Timeline to begin playback. Then select the **Smart Search** button .
3. A grid will appear overlaid onto your camera playback. Highlight an area of interest on the grid. This will define the motion detection area that is used by Smart Search.
4. Select the **Smart Search** button again to begin playback of all motion detected events in the area you selected.

By configuring your recording schedule for motion detection and by using Smart Search, you can quickly find the footage you require. For **Footage Backup**, proceed to Section 5.

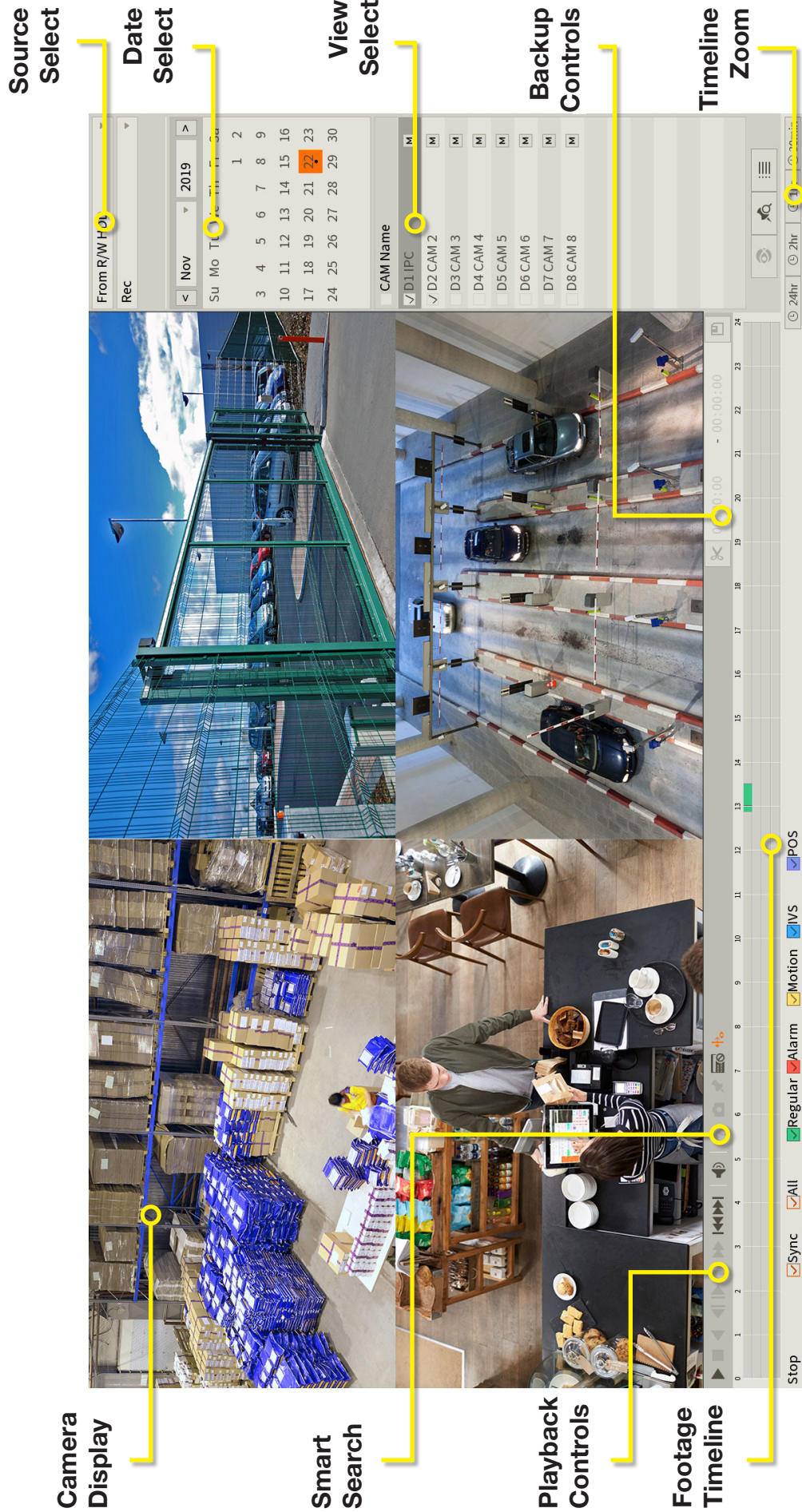

**Fig. 4.2:** Four camera view simultaneous footage playback.

# 5. Footage Backup & Viewing

## 5.1 Backup Footage to USB

Should you wish to preserve recorded footage before it is overwritten, you will need to perform a footage backup. Footage can be exported from your NVR in a **.DAV** or **.MP4** file. A **.DAV** file will require conversion for sharing, whereas an **.MP4** file is compatible with most video players on Windows or Mac PCs. Each file type is covered in Section 5.2.



There are two different ways to backup footage to USB: via the **Search** menu through searching playback footage; and by performing a direct backup via the **Backup** menu. Both are accessed via the **Main Menu**.

File selection (**.DAV/.MP4**) is only available in the **Backup** menu. Backup in **Search** Menu outputs **.DAV** files only.

**Note:** When backing up footage to an external HDD, it will first need to be formatted by selecting the **“Format”** button. **This will clear all data on the external HDD.**

### 5.1.1 Backup Footage via Search Menu

Using the **Search Menu**, find start/end points of backup footage by using playback video as a reference.

1. As detailed in Section 4, locate the footage you wish to backup. Select the desired camera in single view mode.
2. Using the **Footage Timeline**, click the approximate desired time for your backup video start point. Selecting the **Clip Button**  on the **Backup Controls** (Fig. 5.1), this will set your start point.
3. Again, using the **Footage Timeline**, click the approximate desired time for your backup video end point. Select the **Clip Button** again to set your end point.
4. Select the **Save Button**  to open the **Backup** menu.
5. This process can be repeated to add more clips from different channels.
6. Plug in your USB device, exiting any automated prompts, and select **Backup** to begin backup.

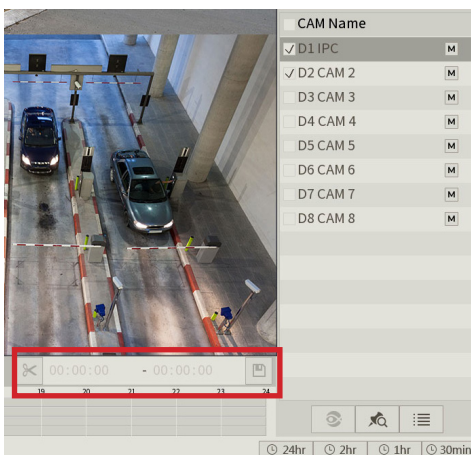

Fig. 5.1: Backup Controls in Search Menu.

### 5.1.2 Backup Footage via Backup Menu

Using the **Backup Menu**, specify start/end dates & times across multiple cameras simultaneously. This is useful for large footage export, such as full days.

1. Select **Backup** from the **Main Menu**, or, insert your USB device and select **File Backup**.
2. Here, you can select the **Type** of footage to backup (default: All), the **Start Time** and **End Time** and what **Record Channels** to backup video from.
3. Selecting **Search** will populate the list with individual video clips ready for backup. Clips can be added or removed from the backup process using the check box.
4. Select **Start** to begin backup.

**NOTE:** Regular type footage (R) will be split into in one hour segments, unless Motion Detection type footage (M) was recorded.

Storage capacity is also shown. Ensure you have the required storage to accept the backup video.

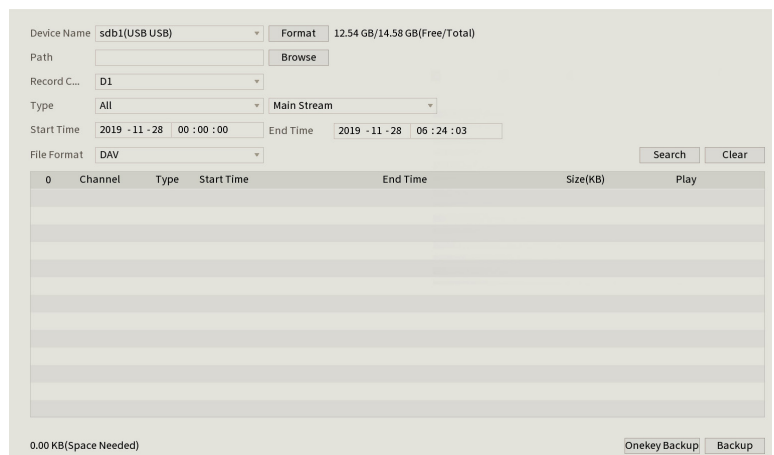

Fig. 5.2: Backup Menu

## 5.2 Viewing Footage on a Computer





The following details instructions for viewing footage on Windows or Mac personal computers. Video conversion may need to take place for viewing on other devices, eg: smartphones, tablets, etc.

Now that you have backed up footage to a USB in .DAV / .MP4 format, you are ready to view it on a personal computer.

- **.DAV footage** can be viewed using the **Smart Player Lite** program and cannot be played on mainstream media players without file type conversion.
- Smart Player can export your videos to .AVI file type to be viewed using another media player such as Windows Media Player & VLC Media Player
- **.MP4 footage** can be directly viewed using most players, including Windows Media Player & VLC Media Player

### 5.2.1 Viewing .DAV Video Files on PC with Smart Player Lite

**Note:** *Smart Player Lite* is automatically copied onto the USB device when performing footage backup from the NVR.

1. To view .DAV footage in Smart Player Lite, either click the **Add Files**  button and select the file from your USB, or drag & drop the file onto a selected play window.
2. Using the .DAV file, Smart Player Lite adds functionality similar to your NVR in footage playback, such as synchronous playback of multiple channels.
3. Open the **Options menu** . Here, you can set the directories and formats for saved snapshots (.BMP/.JPG) and videos (.DAV/.AVI). You can also adjust video aspect ratio and other options.
4. You can **export clips** by pressing the **Record button**  once to begin recording, then again to end recording.
5. Similarly, you can **take snapshots** by pressing the **Snapshot button**  once.

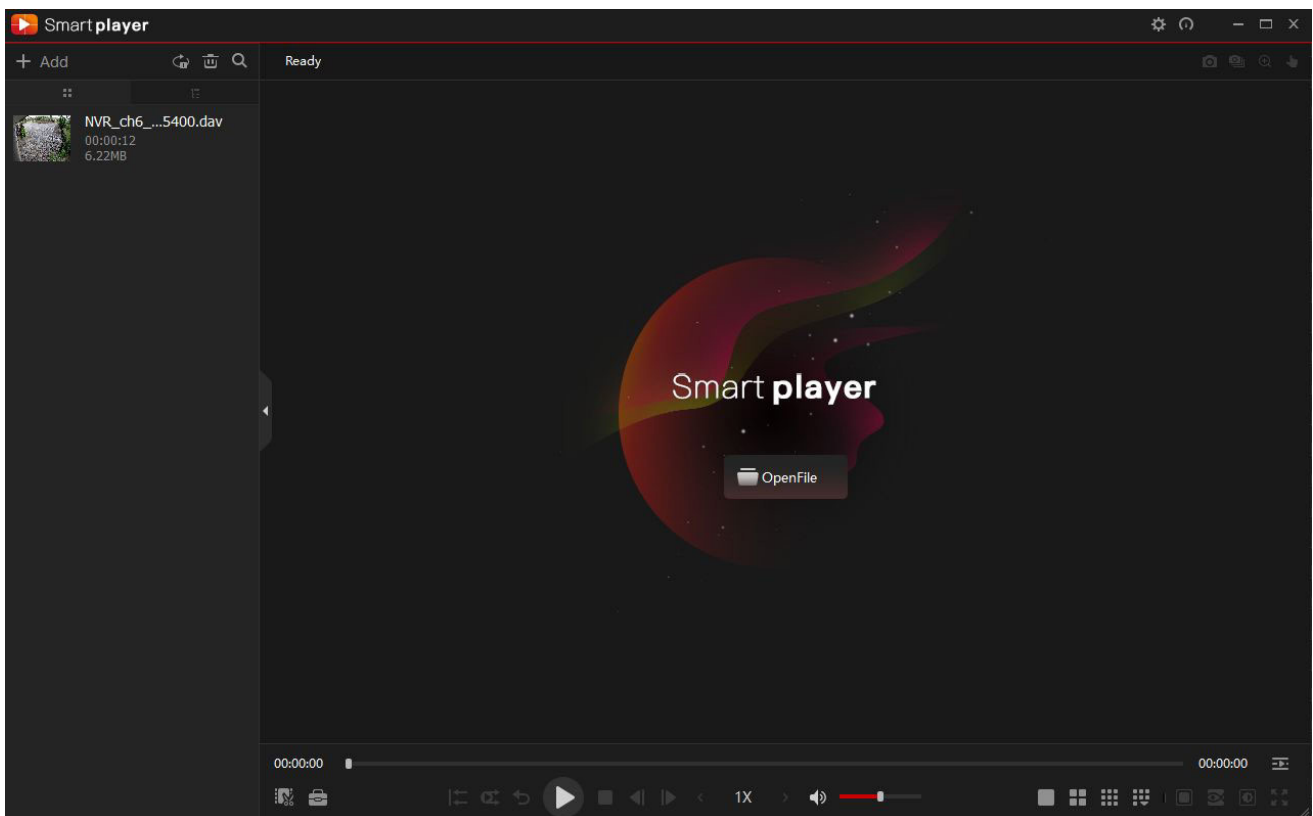

**Fig. 5.3:** Footage playback using the included Smart Player Lite for Windows

## 5.2 Viewing Footage on a Computer (cont.)

If you want to play the video on a different device that does not have Smart Player program, select **Export Type** as .AVI. File type .mp4 can be viewed on a wider range of devices, however you cannot choose to export files as .mp4 on the Smart Player program. You must export files as .mp4 via the recorders back up menu.

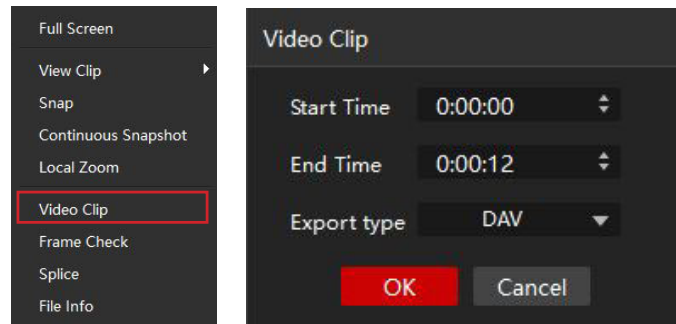

**Fig. 5.4:** Exporting footage to .AVI File on Smart Player program

### 5.2.2 Viewing .MP4 Video Files

The .MP4 file format is a common video format, compatible with Windows Media Player and most other video players. .MP4 videos can also be played by **VLC Media Player**. This free open source player is available across many platforms, including:

- **Desktop:** Windows, Mac OS and Linux
- **Mobile:** Android and iOS

1. Access your USB device and open your backup .MP4 footage video using one of the media players mentioned above.
2. .MP4 files **cannot** be viewed using Smart Player Lite. They do not retain time/date data like .DAV files.

Software utilised in this manual was current at the time of manual creation.

For the latest version of surveillance software for PC and Mac systems, please scan the QR code or follow the link to the right.

A brief overview of key software is listed below:

**SmartPSS:** Remote view application for live view, playback and configuration of your surveillance system. For Windows & Mac PCs.

**Smart Player:** Playback exported footage & convert video files for Windows & Mac PCs.

**DMSS:** Mobile surveillance application for iOS & Android



Scan QR code or navigate to:  
[help.c5k.info/software/software-downloads](http://help.c5k.info/software/software-downloads)

## 6. AI Functions

**NOTE:** Before enabling AI features, ensure that you have configured Intelligent recording schedules (refer to [3.4.2 Configuring Recording Schedules](#)), or these functions will not work.

There are 2 different ways AI can be processed - **By Camera** or **By Recorder**. By Camera means the AI processing takes place in the camera itself. By Recorder means the AI processing is done by the Recorder, not the camera. Please note that AI by Camera can only be used if the camera supports the feature. AI by Recorder must be used if the camera does not support the AI function, however there is a limited amount of channels that can be used for each feature (varies by Recorder model, check Recorder specifications for more information).

AI lets your CCTV system go beyond surveillance, delivering advanced & powerful detection tools. When properly configured, these functions can alert you to suspicious activity in real time via email/smartphone notification and let you easily search through surveillance footage via event history.

Below will explain the different types of AI functions. Keep in mind that functions are camera and recorder specific.

- **Smart Motion Detection** – Smart Motion Detection is an AI filter (provided via **Perimeter Protection**) for Motion Detection that will only trigger an event if a human/vehicle is detected.
- **Intelligent Video Surveillance:**
  - **Tripwire** – A virtual line is drawn over the camera image. If it gets broken, an event will be triggered. Suitable for both indoor and outdoor locations, with the camera mounted up high, looking down. AI functionality can be added to the tripwire via **Perimeter Protection** to enable events to trigger for people and/or vehicles only.
  - **Intrusion** – A virtual area is drawn over the image. If it gets broken, an event will be triggered. Suitable for both indoor and outdoor locations, with the camera mounted up high, looking down. AI functionality can be added to the intrusion via **Perimeter Protection** to enable events to trigger for people and/or vehicles only.
  - **Fast-Moving** – A virtual area is drawn over the image. If a fast-moving object is detected, an event will be triggered. Best suited for outdoor environments such as driveways.
  - **Parking Detection** – A virtual area is drawn over the image. If a vehicle parking is detected, an event will be triggered.
  - **Crowd Gathering** – A virtual area is drawn over the image. If a group of people is detected entering the area, an event will be triggered.
  - **Loitering** - A virtual area is drawn over the image. If someone is standing in the area for a set amount of time an event will be triggered. Best suited to a shop.
- **Smart Object Detection:**
  - **Abandoned** – A virtual area is drawn over the image. If an object gets left in the area and event will be triggered.
  - **Missing** – A virtual area is drawn over the image. If an object is missing in the area, an event will be triggered.
- **Face Detection** – Face Detection will trigger whenever any face has been detected. Best suited for use directly above entry doors.
- **Face Recognition** – Trigger events upon detecting specific pre-determined faces from a face database. Face Detection must be used in conjunction with Face Recognition.
- **People Counting** – Counts the number of people who cross a line (Line Crossing), are currently in an area (Region) or currently in an area and how long they've been there for (Queuing).
- **ANPR** – Automatic License Plate Recognition – Used to trigger events after a number plate is detected.
- **Heat Map** – A colour gradient overlay indicating the level of human traffic in each area of the image over a set period of time.

## 6.1 Mounting Surveillance Cameras for AI Functions

When using AI features, correct camera mounting is crucial for AI triggers to be reliably received. Use the information below to mount the cameras correctly.

### 6.1.1 Mounting for Face Detection/Recognition

When using face detection and/or face recognition, the camera will need to be dedicated to the task. It will need to be focused on the entry point to the premises, not covering a wide area.

When installing the camera it is vital to ensure that scene is well lit. Avoid light coming from the back or sides of the scene.

#### Recommended Mounting Distance

3.6mm 2.0MP IP camera

Parameter	Recommend Value
Height (H)	2.5m
Horizontal Distance (D)	6m
Degrees	15°

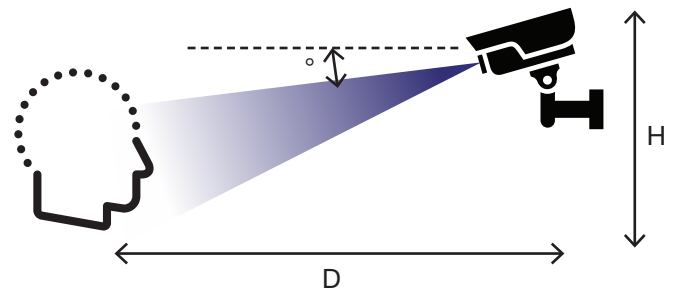

Fig. 6.1: Face Detection mounting diagram

### 6.1.2 Mounting for ANPR

When using ANPR, the camera will need to be dedicated to the task. It will need to be focused on the entry point to the premises, not covering a wide area. For example, it can be used in a driveway at an electric gate, or at a shopping center with a boom gate.

The camera needs to get a clear image of the number plate, with the vehicle at a standstill.

At night, light emitted from the infrared illumination LEDs on the camera must reflect from the number plate and return into the camera lens. If the angle is too sharp, the light will bounce away from the lens and the number plate will not be readable. At the same time, you must ensure that the camera is mounted in a location where it is not subjected to the direct beam from the vehicle headlights for long enough to get an image – halogen lights will overwhelm the image sensor resulting in glare that cannot be corrected by the software highlight compensation.

#### ANPR Camera Mounting – From center of driveway

Parameter	Recommend Value
Height (H)	2.5m
Horizontal Distance (D)	6m
Degrees (°)	10°

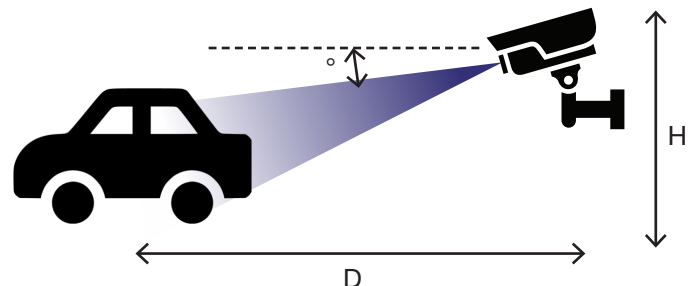

Fig. 6.2: ANPR mounting diagram

## 6.1 Mounting Surveillance Cameras for AI Functions (cont.)

### 6.1.3 Mounting for People Counting

When installing a camera for use with people counting, the camera must be looking top down. The doorway must be no more than 3m wide. If the doorway is wider than 3m, a second camera may be required.

#### People Counting – Distance from Floor – 2MP 3.6mm IP Camera

Parameter	Recommend Value
Height (H)	3m



Fig. 6.3: People Counting camera view example

### 6.1.4 Mounting for Tripwire, Intrusion, Missing, Abandoned, Fast Moving, and Loitering

When installing a camera for use with any of the above functions, the camera will need to be positioned looking over the area. When the trigger area is drawn, it should not be around the edges of the image, as this will cause inconsistent triggers.



Fig. 6.4: Tripwire camera view example



Fig. 6.5: Intrusion camera view example



## 6.2 AI Live View

AI Face Detection & Recognition results can be displayed in real-time on the Live View screen. This will show every face that is captured by the AI system, and additionally, if Face Recognition is activated, compare it to faces in the database and show comparison results (with accuracy %).

### Enabling AI Mode in Live View

1. While on the Live View screen, **right-click** to open the menu.
2. Hover over **Live Mode**.
3. By default, the General Live Mode is enabled. Select **AI Mode**.
4. If AI & IVS have been configured correctly, live capture results should now be displayed on the right side of the screen.
5. Filter the event options displayed in the list via the Settings icon in the top right corner.

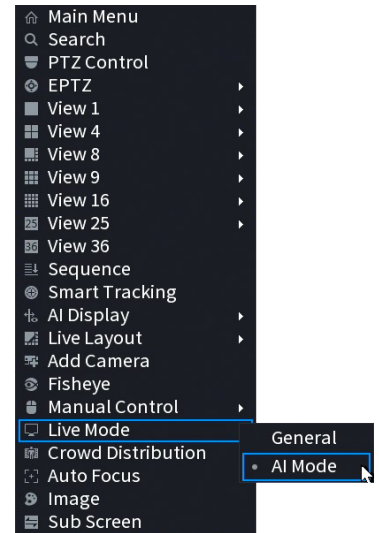

Fig. 6.6: AI Mode in Live View Menu

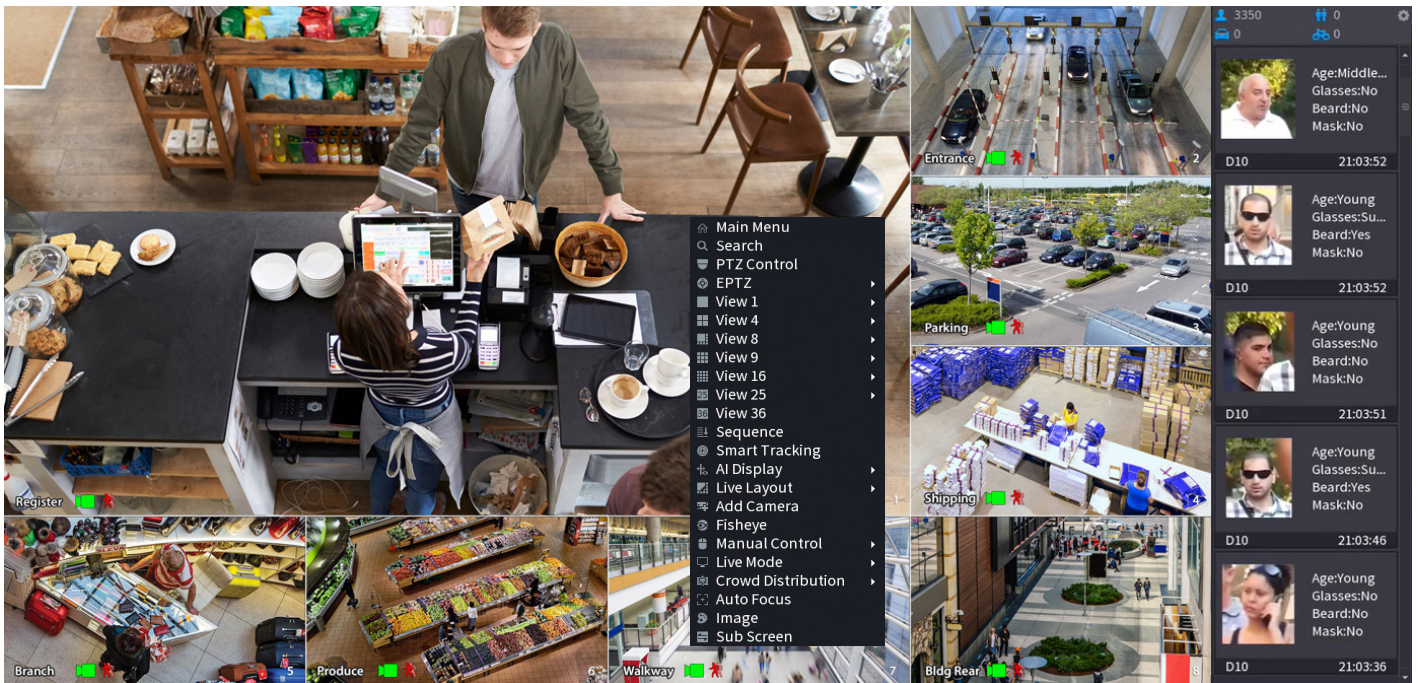

Fig. 6.7: Live playback with Face Detection info on right panel

## 6.3 Motion Detection & Smart Motion Detection

**NOTE:** Before enabling Motion Detection/Smart Motion Detection, ensure that you've configured Motion/Intelligent recording schedules (refer to [3.1.7 Configuring Recording Schedules](#)).

### 6.3.1 Enabling Motion Detection

1. From the **Main Menu**, select **Alarm**.
2. Select the **Video Detection** tab and then the **Motion Detection** Tab.
3. Select the channel you want to **Enable** motion detection on with the **Channel** drop down menu.
4. (Optional) Adjust motion detection sensitivity and area by selecting **Region Settings**.
5. (Optional) Configure what actions are taken once the IVS event is triggered.
6. Click **Apply** to confirm settings.

**Fig. 6.8:** Motion Detection Screen

### 6.3.2 Smart Motion Detection

Smart Motion Detection allows the NVR to identify and differentiate vehicles and people from other moving objects.

1. From the **Main Menu**, select **AI -> Parameters -> SMD**
2. Select the **Channel** to you want to enable Smart Motion Detection for.
3. Set **Type** to **AI by Camera** if the camera supports the function, else use **AI by Recorder**.
4. Click **Enable**.
5. Set a **Sensitivity** level, then which **Effective Targets** will trigger it (**Humans, Vehicles** or **both**).
6. (Optional) If using a Deterrence Camera, toggle **Camera Audio** (Siren) and **Light** (Strobe) per installation requirements.
7. Select **Apply** to confirm settings.

## 6.4 Tripwire & IVS Setup

**NOTE:** Before enabling Tripwire or another IVS feature, ensure that you have configured IVS recording schedules (refer to [3.1.7 Configuring Recording Schedules](#)).

### 6.4.1 Tripwire Setup

1. From the Main Menu, select **AI -> Parameters -> IVS**.
2. Select the **Channel**, you wish to add a Tripwire for.
3. Set **Type** to **AI by Camera** if the camera supports the function, else use **AI by Recorder**.
4. Click **Add button** at the bottom. This will create a new IVS setting (Tripwire by default).
5. Click the **Draw button**  to open the Draw screen (Fig. 6.10).

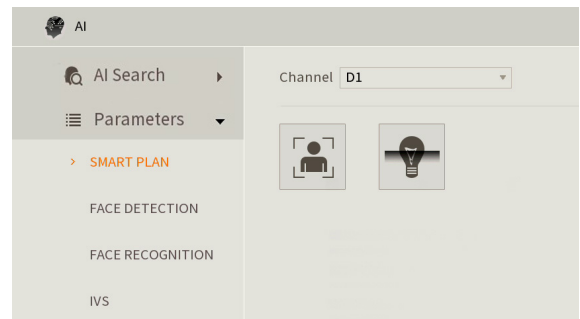

Fig. 6.9: Parameters Smart Plan screen.

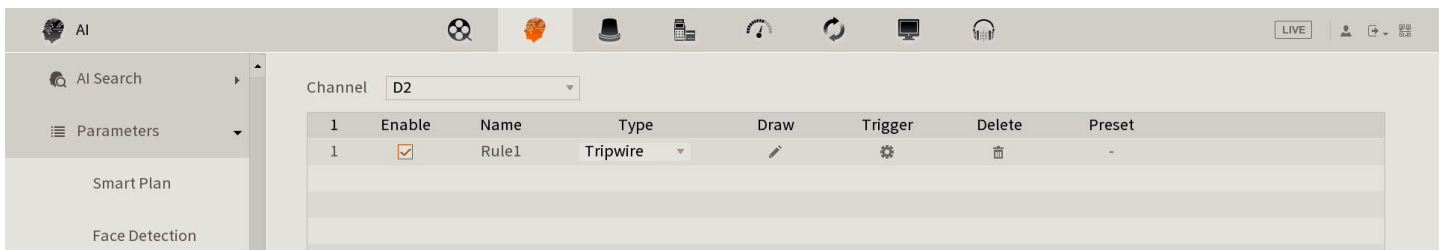



Fig. 6.10: IVS setup screen.

6. **Left-click** on the screen to start drawing the Tripwire line. **Left-click again** to place the line (optionally, you can add additional corners to the line by continuing to left-click). **Right-click** to finish placing the line.
7. (Optional) Set the **Direction** that the line must be passed from to activate the event, as indicated by the arrow going across the line (A to B, B to A, or Both).
8. (Optional) Set the **Action** per installation requirements. We recommend enabling both **Appear** and **Cross** if applicable.
9. (Optional) Enable **Effective Target** and toggle **Human** and/or **Vehicle**.
10. Click **OK** to finish.
11. Click the **Trigger Button**  to bring up the **Trigger menu**, configuring what actions are taken once the IVS event is triggered. (Refer to [7.4 AI Trigger Actions](#)).
12. (Optional) If using a Deterrence Camera, toggle **Camera Audio** (Siren) and **Light** (Strobe) per installation requirements in the
13. Click the **Enable box** to turn on the IVS rule.
14. Click **Apply** to save changes.
15. (If AI by Camera was used) From the Main Menu, select **AI -> Parameters -> Smart Plan**. Select the **Channel** you set the IVS rule up on. Click the , then **Apply** to enable the IVS.

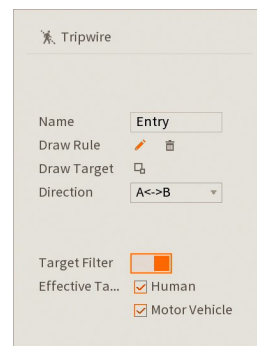

Fig. 6.11: Tripwire Draw menu.

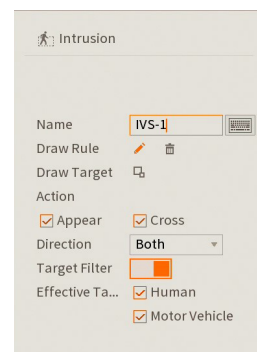

Fig. 6.12: Intrusion Draw menu.

### 6.4.2 Intrusion/Fast Moving/Parking Detection/Crowd Gathering/Abandoned Object/Missing Object

Intrusion, Fast Moving, Parking Detection, Crowd Gathering, Abandoned Object and Missing Object are all set up in similar ways to Tripwire - simply select which IVS you want to set up from the **Type dropdown menu** (Fig. 6.10).

If using Abandoned Object or Missing Object, configuration is done under **AI -> Parameters -> Smart Object Detection** instead.

## 6.5 Face Detection & Recognition

### 6.5.1 Enabling Face Detection

1. From the Main Menu, select **AI -> Parameters -> Face Detection**.
2. Select the **Channel** you want to set up Face Detection for.
3. Set **Type** to **AI by Camera** if the camera supports the function, else use **AI by Recorder**.
4. Select the **Enable** button.
5. (Optional) If you only want to capture faces in a specific area, select **Rule**. Select **Remove** <remove icon> to remove the default rule, then select **Draw** <draw icon> and draw the capture area by left-clicking on the screen to place the corners. Right-click to finish placing the line. Select **OK** to save your changes.
6. (Optional) To adjust the minimum and maximum face detection size, select **Rule**. Select **Target Filter**, then adjust the Min Size and Max Size boxes to suit your installation requirements. The minimum and maximum value will depend on how far away the camera is from the faces that are getting captured, in most cases this setting does not require adjustment. Select **OK** to save your changes.
7. (Optional) If using a Deterrence Camera, toggle **Camera Audio** (Siren) and **Warning Light** (Strobe) under **More** per installation requirements.
8. Select **Apply**.
9. Refer to **6.8 AI Trigger Actions** for further trigger settings.
10. (If AI by Camera was used) From the Main Menu, select **AI -> Parameters -> Smart Plan**. Select the **Channel** you configured Face Detection on. Click the **Face Detection** icon, then **Apply** to enable the Face Detection.

The screenshot shows a configuration window for Face Detection. It is divided into several sections:

- Channel:** A dropdown menu showing "D2".
- Type:** A dropdown menu showing "AI by Re...".
- Enable:** A toggle switch that is currently turned on (orange).
- Rule:** A button labeled "Setting".
- Schedule:** A button labeled "Setting".
- Alarm-out Port:** A button labeled "Setting".
- Post-Alarm:** A text input field containing "10" followed by "sec.".
- Send Email:** An unchecked checkbox.
- Report Al...:** An unchecked checkbox.
- Record Channel:** A checked checkbox, followed by a "Setting" button.
- PTZ Linkage:** An unchecked checkbox, followed by a "Setting" button.
- Tour:** A checked checkbox, followed by a "Setting" button.
- Buzzer:** An unchecked checkbox.
- Log:** A checked checkbox.
- Alarm Tone:** A dropdown menu showing "None".
- More:** A button labeled "More".

Fig. 6.13: Face Detection Parameters menu

## 6.5 Face Detection & Recognition (cont.)

### 6.5.2 Enabling Face Recognition

Used in conjunction with Face Detection, Face Recognition can detect people that have been added to a “Face Database”, and trigger events off this. Generally, this function is used to trigger an action on the recorder when a person in a pre-determined face list is seen.

1. From the Main Menu, select **AI -> Database -> Face Database Config**.
2. Select **Add**.
3. Set the **Type** to Normal Database.
4. Enter a **Name** for the Face Database, then select **OK**.

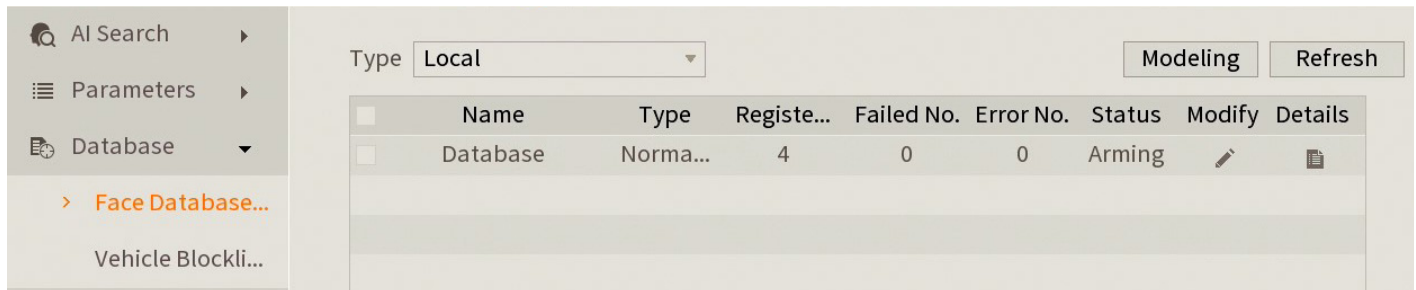

Fig. 6.14: Face Database menu

5. Select **Parameters -> Face Recognition**.
6. Select the **Channel** you wish to setup Face Recognition on.
7. Set **Type** to **AI by Camera** if the camera supports the function, else use **AI by Recorder**.
8. Select **Enable**.
9. Select **General Alarm**, then select **Target Face Database Setting**. Tick the box next to the Face Database you created earlier, then select **OK**.
10. (Optional) If you wish to know when a stranger (Someone not in the database) is detected, select **Stranger Alarm** then select **Enable**.
11. Configure the trigger settings to suit your requirements (Refer to [7.4 AI Trigger Actions](#)).
12. Select **Apply** to save your changes.
13. (If AI by Camera was used) From the Main Menu, select **AI -> Parameters -> Smart Plan**. Select the **Channel** you configured Face Recognition on. Click the **Face Recognition** icon, then **Apply** to enable the Face Recognition.

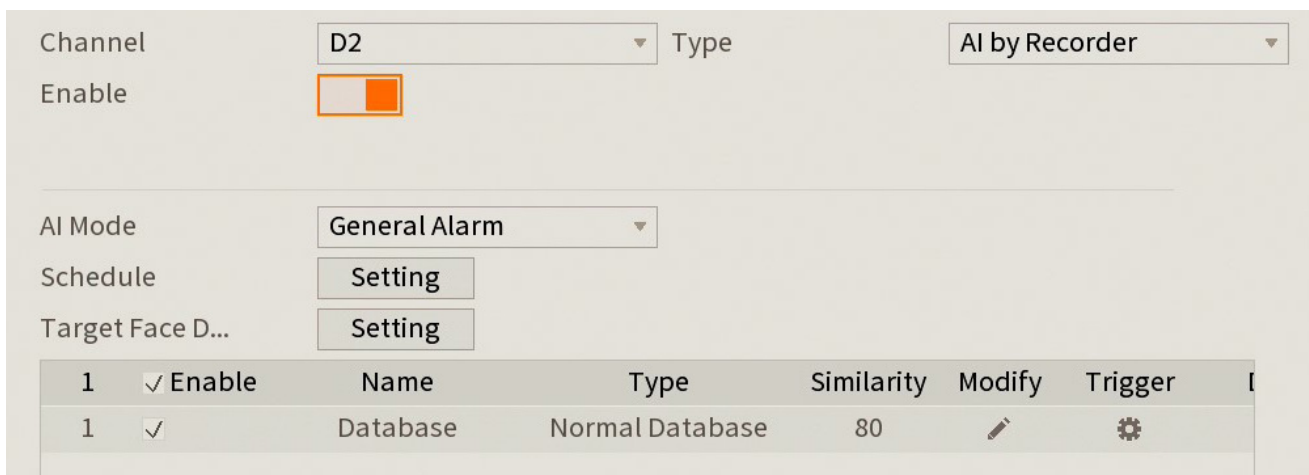

Fig.6.15: Face Recognition menu

## 6.5 Face Detection & Recognition (cont.)

### 6.5.3 Adding Faces to the Face Database via AI Preview

1. Ensure **AI Preview mode** is configured as per section **6.2 AI Live View**
2. Once a face appears in the list you would like to add to the Face Library, **double click** on it, and select **Add to Face Database**.
3. Enter the details of the person, then tick the **Face Database** you would like to add the face to.
4. Select **OK**.

### 6.5.4 Adding Faces to the Face Database via AI Search

1. From the Main Menu, select **AI -> AI Search -> Face Recognition**.
2. Select the **Channel, Period** and any other desired filters, then select **Search**.
3. Find the face you wish to add in the results and select the **Add to Face Database** button next to it.
4. Enter the details of the person, then tick the **Face Database** you would like to add the face to.
5. Select **OK**.

1	✓	Face Library ...	Registered No.	Failure peo...	Error peop...
1	✓	Staff	0	0	0

Fig. 6.16: Add to Face Database window

### 6.5.5 Adding Faces to the Face Database via Manual Photo Upload via USB Flash Drive

This method is useful if multiple faces are being added to the face database. When using this method, the file format must be .jpg and the file name must match the below syntax (Name is required, however the other details are optional):

*Name#SGender#BBirthDay#NRegion#TCredential Type#MCredential No.#AAddress.jpg*

Gender: 1 Male, 2 Female / T Credential Type: 1 – Identity Card, 2 - Passport, 3 – Officer Card

**Example: Tom#S1#B19900101#NUS#T1#M123456789#ANorth Main Street.jpg**

1. Save the face(s) as a .jpg image file(s) with the above file name syntax to a USB Flash drive.
2. Insert the USB Flash Drive into a free USB Port on the NVR.
3. From the Main Menu, select **AI -> Database -> Face Database**.
4. Select **Details** next to the Face Database you wish to add the faces to.
5. Select **Batch Register**, then select **File** or **Folder**, and select the photos you wish to upload.
6. The recorder will then upload the files. Once complete, press **Search** to update the Face Library
7. Select the **Edit** icon next to the faces that have been added, to update name and other details.

### 6.5.5 Deleting Faces from Face Database

To remove a face from a face library, select **AI -> Database -> Face Database**. Select the **Details** button in the face library to view the faces that have been added to it. Select the face you wish to delete, then select **Delete**.

The image format shall be .jpg  
Naming format: Name#SGender#BBirthDay#NCountries&Regions#TID Type#MID No.#AAddress.jpg(Name required, others optional)  
e.g. Tom#S1#B19900101#NUS#T1#M123456789#ANorth Main Street.jpg  
Gender: 1.Male 2.Female  
Type: 1.Identity Card 2.Passport 3.Military Officer Passport

Fig. 6.17: Face details menu

## 6.8 AI Trigger Actions

The options below the enable button on the **Parameters** tab configure the actions taken after an event has been triggered such as face detection, or tripwire.

1. **Schedule** - Sets the times of day that the event will trigger (always on by default).
2. **Alarm Out** - Sets an external alarm to activate whenever the event is triggered.
3. **Post-Alarm** - Sets how long the system waits after a trigger before detecting again (10 seconds by default).
4. **Send Email** - Notifies a specified email address whenever the event is triggered (Requires internet connection & setup)
5. **Report Alarm** - Updates the alarm system status on the network (Unused for this system).
6. **Record Channel** - Sets which camera to record to when the event is triggered.
7. **Post-Record** - Sets the amount of time recorded after the event is triggered.
8. **PTZ Linkage** - Set PTZ behaviours in response to an event trigger, such as selecting a Tour to perform, etc (For use with PTZ camera(s) only).
9. **Tour** - Starts a display tour when the event is triggered.
10. **Buzzer** - Sets the NVR to beep whenever an event is triggered.
11. **Alarm Tone** - Plays a designated .wav file in response to an event trigger. This can be imported via a USB flash drive to the NVR.
12. **Camera Audio** - (Deterrence Camera only) Activate the siren of the Deterrence camera when the event is triggered.
13. **Warning Light** - (Deterrence Camera only) Activate the strobe of the Deterrence camera when the event is triggered.

The screenshot shows a 'Trigger' configuration window with the following settings:

Alarm-out Port	Setting	Post-Alarm	10 sec.
<input type="checkbox"/> Send Email		<input type="checkbox"/> Report Al...	
<input checked="" type="checkbox"/> Record Channel	Setting	Post-Record	10 sec.
<input type="checkbox"/> PTZ Linkage	Setting		
<input type="checkbox"/> Tour	Setting		
<input type="checkbox"/> Buzzer	<input checked="" type="checkbox"/> Log		
<input type="checkbox"/> Alarm Tone	None	More	

At the bottom right, there are two buttons: 'OK' (highlighted in orange) and 'Back'.

**Fig. 6.18:** Trigger Actions menu

## 6.9 Disarming

Disarming can be used to temporarily disable alarm options on the NVR (e.g Deterrence Camera Siren and Strobe).

Disarming can be toggled via the following methods:

- Setting **Disarming** to **On/Close** on the **Alarm -> Disarming** page.
- Selecting the <icon> icon next to the time & date on the Live View Page. Red is armed, grey is disarmed.
- Toggling **Disable Alarm Linkage** under **Device Details** in the DMSS app. The NVR will be disarmed when **Disable Alarm Linkage** is enabled.

To configure Disarming options navigate to **Alarm -> Disarming** from the **Main Menu**

1. **Disarming** - “Disarms” the system per the below parameters when set to **On**.
2. **Disarm by Period** - Enable to disarm the system according to the **Duration of Disarm by Period** schedule
3. **Duration of Disarm by Period** - Scheduled time period that the system will be disabled for when **Disarm by Period** is enabled.
4. **Event Notifications** - Set to **Close** to disable push notifications when the system is disarmed. We recommend leaving this as **On** unless you combine it with Disarm by Period to only receive notifications during a specific time period.
5. **Disable Alarm Linkage Actions** - Toggle **AI Trigger** features (Buzzer, Show Message, Alarm-Out Port, Send Email, Report Alarm) to be disabled when disarming is active
6. **Sync Disarm Config with Channels** - Select the channels to sync disarming settings with. Channels that are not selected in the list will not be able to be disarmed via the NVR.

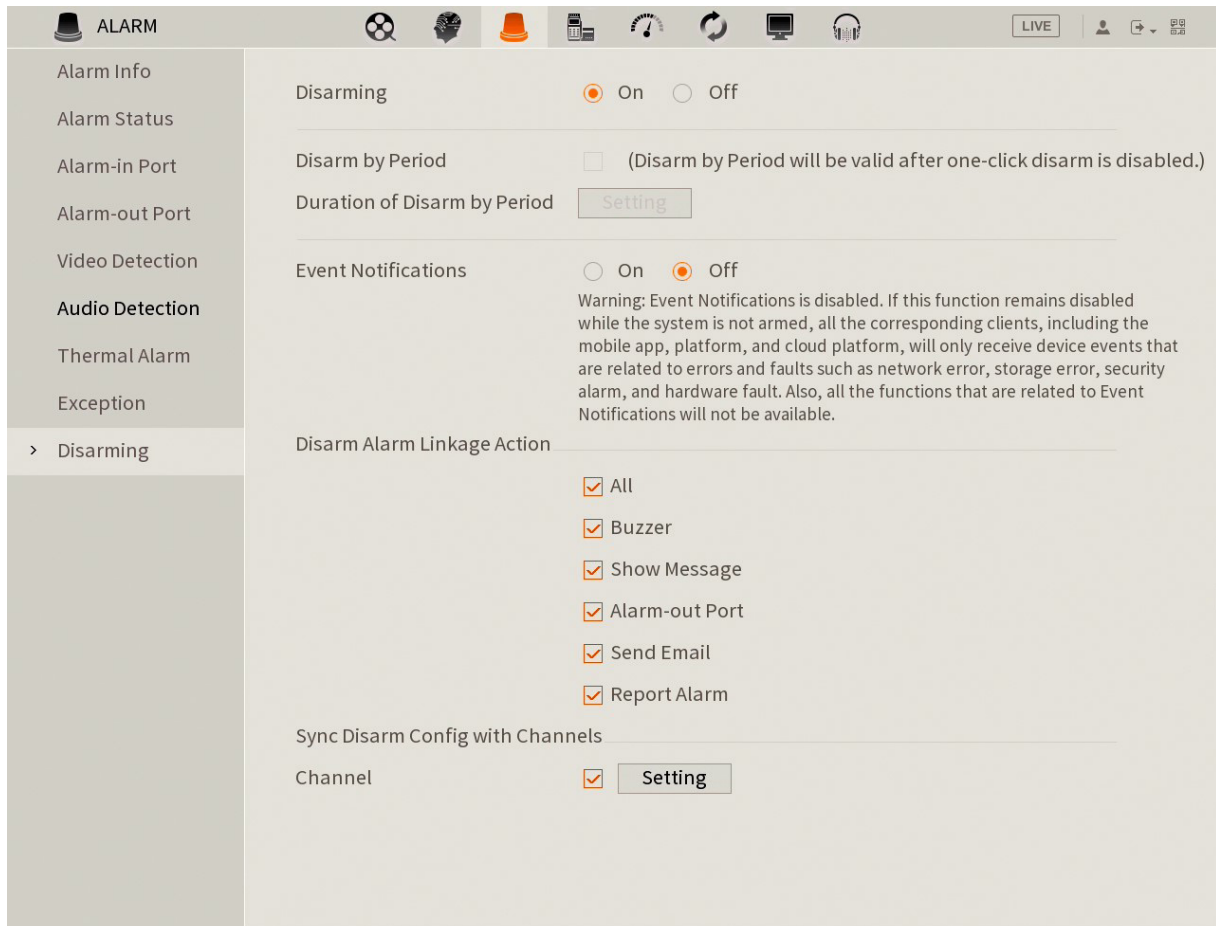

Fig. 6.19: Trigger Actions menu



# 7. AI Search

## 7.1 AI Search

AI Search can be used to view events for configured AI functions without needing to go through the Search menu. The AI function must be configured (refer to section **6. AI Functions**) and Intelligent recording must be scheduled (refer to section **3.4.2 Configuring Recording Schedules**) in order to use the AI Search function.

### 7.1.1 AI Search

1. From the Main Menu, select **AI -> AI Search** then select the **AI function** you wish to view events for (e.g Face Detection, Face Recognition, IVS, SMD, etc).
2. Select the **Channel(s)** you wish to search.
3. Select the **Period** you wish to search.
4. (Optional) Select any other filters you wish to apply to the search (e.g Gender for Face Detection).
5. Select the **Search** button.
6. If any events were recorded that match the chosen channel/period/etc filters, they will be displayed along with a timestamp. Double-click on one of the results to view the recorded footage.
7. If you wish to backup the recorded events, insert a USB stick, put a tick next to the item you want to backup, and select **Export**. Then you will be asked where on the USB Stick the file is to be saved.
8. Select **OK** to start the backup.

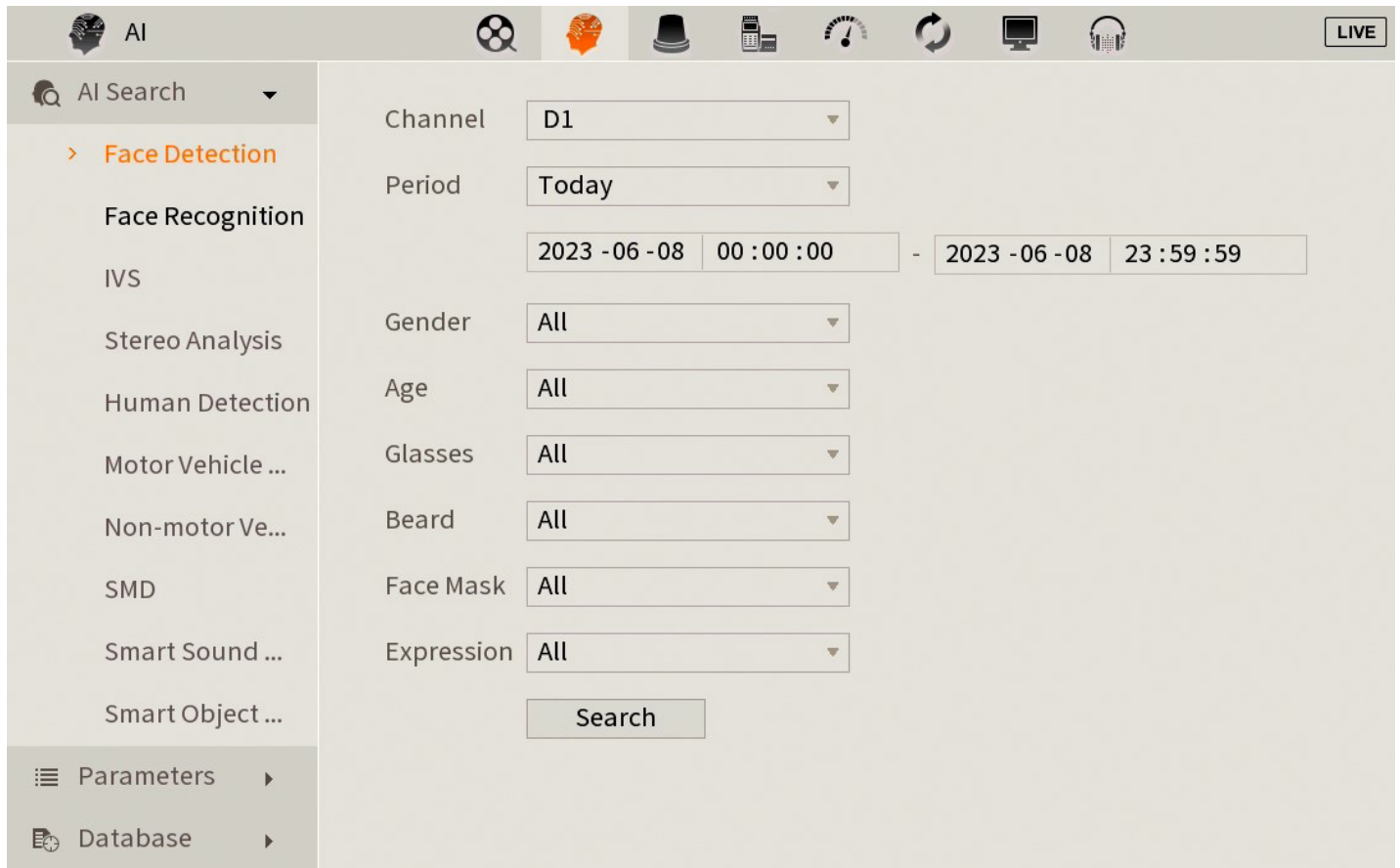

Fig. 6.20: Face Detection AI Search menu

## 7.1 AI Search (cont)

### 7.1.2 AI Search for Face Recognition via Search by Picture

1. From the Main Menu, select **AI -> AI Search -> Face Recognition**. Select the **Search By Picture** tab.
2. (Search for Face in Face Database) To search for a face that has been added to a Face Database, select **Face Database**, then select the database from the **Face Database** dropdown list and select **Search**. Left-click on each face you wish to search for, then select **OK**.
3. (Search for Face from USB Image) To search for a face from USB image, select **Local Upload** then select the image file to import it.
4. **Left-click** the faces you wish to search for to select them, they will be highlighted in blue when selected.
5. Select the **Channel** and **Period**, then **Search**.
6. If any matching faces were detected in the specified timeframe, they will be displayed along with a timestamp. **Double-click** on one of the faces to view the recorded footage.
7. If you wish to backup the recorded events, insert a USB stick, put a tick next to the item you want to backup, and select **Export**. Then you will be asked where on the USB Stick the file is to be saved.
8. Select **OK** to start the backup.

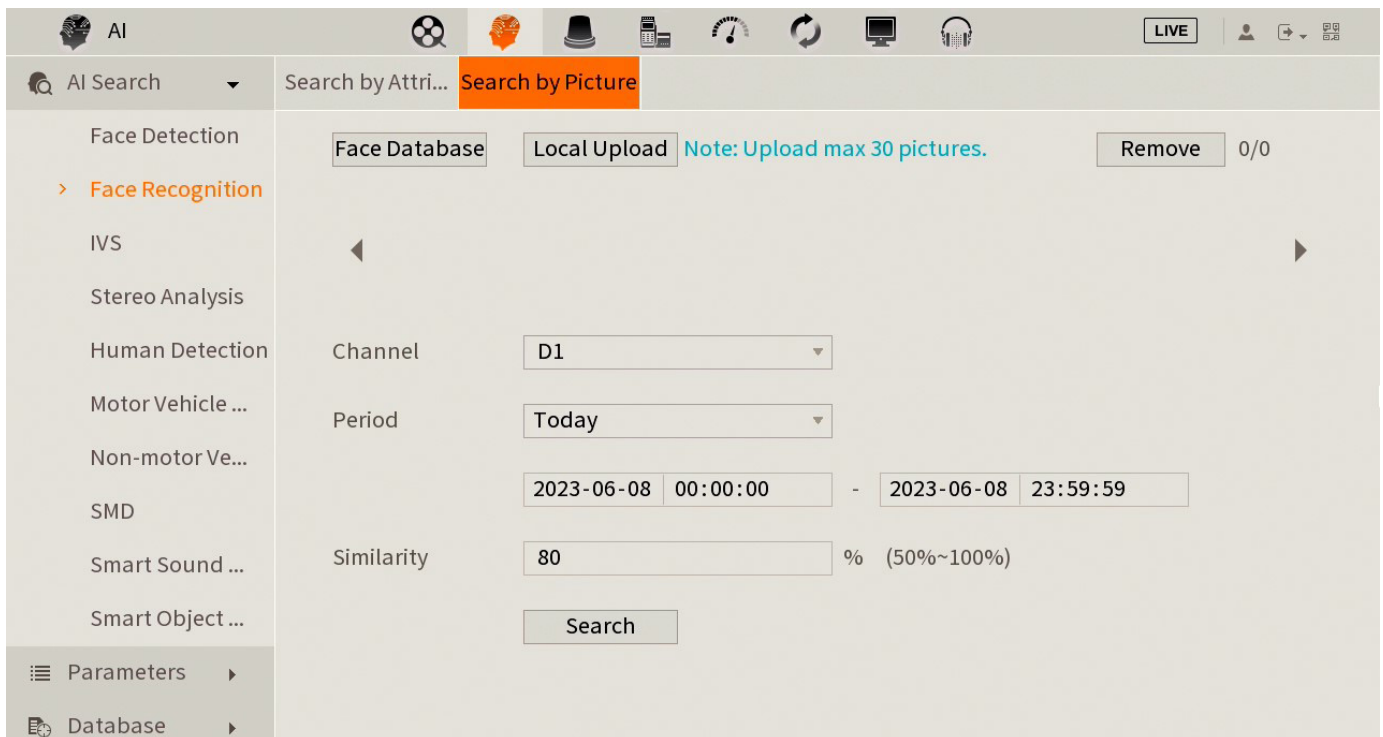

Fig. 6.21: Search by Image menu

## 8. Troubleshooting

This concludes the Quick Start Guide covering the basic functionality of your surveillance system. Should you encounter any difficulties with your setting up and using your system, please first refer to the tables below.

Area	Menu Navigation	Guide Ref.
NVR Security Setup	Main Menu -> Management-Account -> Security	Section 3.1.3
Changing General Settings	Main Menu -> Management-System -> General	Section 3.1.2
NVR Network Setup	Main Menu -> Management-Network -> TCP/IP	Section 3.1.4
P2P & Remote View Setup	Main Menu -> Management-Network -> P2P	Section 3.1.4
Configuring Cameras	Main Menu -> Management-Camera -> Camera List	Section 3.1.5
Changing Recording Schedule	Main Menu -> Management-Storage -> Schedule	Section 3.4.2
Display Settings	Main Menu -> Display	Section 3.5
Accessing Playback Footage	Main Menu -> Search	Section 4
Backing Up Footage	Main Menu -> Backup	Section 5
Intelligent Function Setup	Main Menu -> AI -> Parameters -> Smart Plan	Section 6

Problem	Troubleshooting	Guide Ref.
The NVR won't power on.	<ul style="list-style-type: none"> <li>Ensure that the power cable is firmly connected to the recorder &amp; wall socket.</li> <li>Confirm that there is power from the outlet.</li> </ul>	Section 1.2
The NVR is not being displayed on the monitor.	<ul style="list-style-type: none"> <li>Ensure the display cable is firmly connected to the recorder &amp; monitor.</li> <li>Ensure you have selected the correct input on your monitor.</li> <li>Reset the NVR resolution by powering on the unit while holding SHIFT.</li> <li>Test the recorder's display output with different monitor.</li> </ul>	Section 1.2
Cameras aren't displaying live video.	<ul style="list-style-type: none"> <li>Ensure that you are not in playback mode, right mouse click to exit.</li> <li>Ensure the camera is connected to the CAT5e or CAT6 cable, and the camera has been terminated to TIA-568A or TIA-568B Standard.</li> <li>Swap with known working cables and cameras to test.</li> </ul>	Section 1.2
The NVR is not recording video.	<ul style="list-style-type: none"> <li>Check Storage -&gt; Record is set to "Auto".</li> <li>Check if the HDD is installed and properly connected.</li> <li>Check that the recording method you have chosen to implement is in use.</li> </ul>	-
Motion is not being detected or recorded by the NVR or unable to Smart Search.	<ul style="list-style-type: none"> <li>Check that motion detection is enabled by navigating to Main Menu -&gt; Alarm   Alarm -&gt; Video Detection -&gt; Motion Detect. The Enable check box should be switched on for all relevant channels.</li> <li>Ensure that a period has been selected in the Recording Schedule for motion detection recording and that the period is filled in yellow.</li> <li>Check motion sensitivity and adjust motion detection area, see: Main Menu -&gt; Alarm -&gt; Video Detect: Motion Detect -&gt; Region Settings</li> </ul>	Section 3.1.7
Cannot connect to NVR on smartphone or tablet.	<ul style="list-style-type: none"> <li>Ensure that the NVR &amp; device are connected to the Internet and that the connection is strong enough to receive video (min. 3G speeds).</li> <li>Check that P2P is Online in Network -&gt; P2P. If offline, turn DHCP on.</li> <li>Ensure that the admin password is correct in the DMSS app</li> <li>Ensure the extra stream settings are set to recommended settings.</li> </ul>	Section 3.1.5
The recorder will not detect a USB device for backup.	<ul style="list-style-type: none"> <li>If a USB device is detected but you are unable to backup footage to it, format it by using the Format button on the Backup page. NOTE: This will erase all data on the USB</li> <li>Ensure that the USB device is formatted to FAT32 or NTFS.</li> <li>Try using another USB flash drive to test compatibility.</li> </ul>	Section 5.1
Face Detection / IVS features are not working correctly.	<ul style="list-style-type: none"> <li>Check that Smart Plan is enabled if using AI by Camera.</li> <li>Ensure that IVS (blue) recording schedules have been set up in Schedule.</li> <li>Ensure that Enable has been checked for each rule on the IVS screen.</li> </ul>	Section 3.1.7 Section 6.3
Decode Disabled	<ul style="list-style-type: none"> <li>Ensure you are connected to HDMI1 if only using one display.</li> <li>Turn on "Enable Decode" for Sub Screen if using two HDMI/Both VGA and HDMI</li> </ul>	-



For detailed technical support and software downloads,  
visit our Help Centre at: [help.c5k.info](https://help.c5k.info)

All products, designs and software may be subject to change without prior written notice. Information, layout and graphics presented in this guide are the property of their respective owners.

See [www.c5k.info](https://www.c5k.info) for more information.