

digitech

Slimline Indoor UHF/VHF Antenna with Signal Meter



User Manual
LT-3158

Box Contents:



1 x Slimline Indoor UHF/VHF Antenna

1 x Antenna Stand



1 x Mains Power Adaptor



1 x Wall Mounting Hardware

Product Diagram:

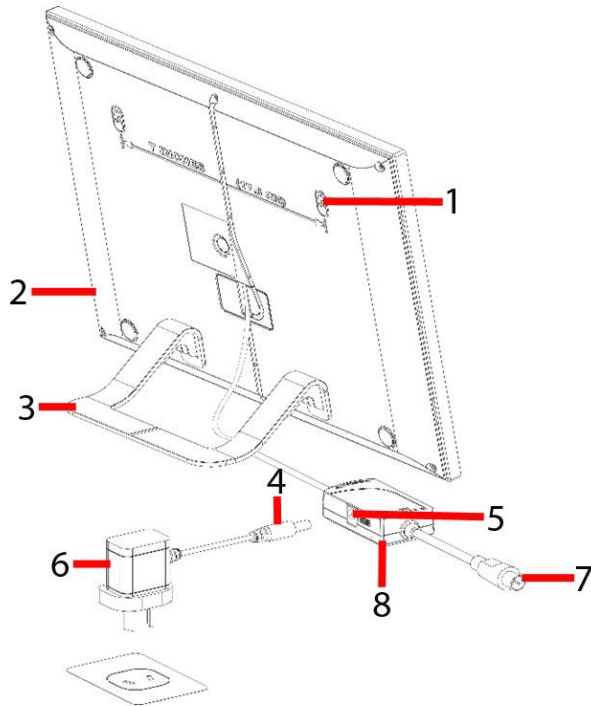



#	Feature:	Description:
1.	Mounting Holes	Use the mounting hardware to attach to a wall
2.	LED Signal Meter	Displays the TV reception signal strength located on the front side
3.	Antenna Stand	Attach the stand to be used on a desk or TV cabinet
4.	DC Power Plug	Connect to the DC power socket of the power injector
5.	DC Power Socket	Connect to the DC power plug of the mains power adaptor
6.	Mains Power Adaptor	Connect to a standard 240VAC wall outlet and the DC power socket to the power injector
7.	PAL TV Connector	Connect directly to your TV or set top box
8.	Power Injector	Connects between the mains power adaptor and TV

Operation:

1. Insert the PAL connector of the power injector into the socket of your TV or set top box.
2. Connect the DC plug of the mains power adaptor to the DC power socket of the power injector.
3. Connect the mains power adaptor to a standard 240VAC wall outlet and turn it on.
4. Once the power has been turned on; the power injector should show a blue LED to indicate it is now powered on correctly.
5. Turn on your TV and set top box and run a channel search scan.
6. The LED signal meter on the front of the antenna will show you the current reception signal strength. Try to reposition the antenna if you're getting low signal or you may be in a low signal area. Refer to the reception page of the user manual.

Note: Please refer to your user manual of your TV or set top box if you're unsure on how to complete a channel search scan.

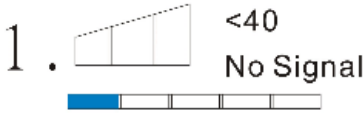
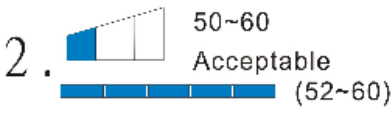
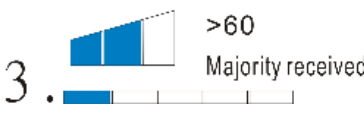
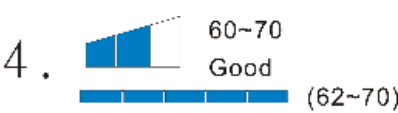
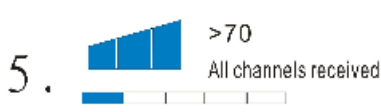
LED Signal Meter:

Diagram	Bars	Signal
<p>1.  <40 No Signal</p>	<p>Top Bar: 0 Bottom Bar: 1</p>	<p>No Reception/Unstable</p>
<p>2.  50~60 Acceptable (52~60)</p>	<p>Top Bar: 1 Bottom Bar: 1-5</p>	<p>Minimal reception, Only partial channels may be received</p>
<p>3.  >60 Majority received</p>	<p>Top Bar: 2 Bottom Bar: 1</p>	<p>Majority of channels can be received, partial amount may be lost</p>
<p>4.  60~70 Good (62~70)</p>	<p>Top Bar: 2 Bottom Bar: 1-5</p>	<p>Good reception, Most channels can be received</p>
<p>5.  >70 All channels received</p>	<p>Top Bar: 3 Bottom Bar: 1</p>	<p>Good reception, All channels can be received</p>
<p>6.  >80 Over</p>	<p>Top Bar: 3 Bottom Bar: 1-5</p>	<p>Best reception, all channels can be received.</p>

Reception:

This antenna is suggested for use up to a 25km distance to the TV tower. Please note that obstacles in-between the tower and receiver such as buildings or walls may affect the distance.

Please refer to the following websites to check the coverage in your area:

Australia - <https://myswitch.digitalready.gov.au/>

New Zealand - <https://www.freeviewnz.tv/faq-library/about-digital-tv/coverage-maps/>

For best reception; please try the following steps:

1. Reposition or change the direction of your antenna to try and obtain better signal. Run a channel search again on your TV once the antenna has been moved.
2. The antenna distance to the TV tower may be affected by objects in-between; it is suggested to change the position of the antenna to try and avoid these objects. Objects such as microwaves may affect the signal. The signal strength may be far greater even by moving the antenna a short distance.
3. Mount the antenna as high as possible on a wall or cabinet.
4. It is suggested not to place the antenna near your TV as it may cause interference.

Troubleshooting:

Problem:	Solution:
Antenna won't power on	Connect the mains power adaptor to the DC socket of the power injector and connect properly to a 240VAC wall socket.
	Check to see if the mains power adaptor is working correctly.
No Reception / Low Reception	Reposition the antenna in a different position or direction.
	Check to see if you're within a 25km distance of your TV tower. Check the coverage websites located in the reception section.
	Move the object away from your TV as it may reduce the signal reception.
	Keep the antenna away from obstacles such as the microwave or any metal objects as it may cause interference.
LED signal meter shows signal but I'm not receiving any channels	The signal meter only shows the average signal level. It is suggested to move the antenna in a different place and do another TV channel scan.

Safety:

1. Do not open the case of the antenna to avoid damage and injury.
2. Keep the antenna away from high temperatures as it may cause damage to the antenna.
3. Do not expose the antenna or mains power adaptor to water, moisture or liquids to prevent the unit from damage.
4. Make sure the mains power adaptor is connected correctly to a standard 240VAC wall socket.
5. If using a replacement or third party mains power adaptor; make sure the voltage and current match the specifications as 6VDC, 150mA.

Features:

- . LED Signal Strength Meter
- . In-Built Amplifier
- . 4G/LT Filter
- . Automatic Gain Control
- . Stand & Wall Mountable

Specifications:

UHF Frequency: 470-862MHz

VHF Frequency: 170-230MHz

Antenna Gain: 26dB \pm 3 (UHF)

30dB \pm 3 (VHF)

Distance to TV Tower: Up to 25km

Channels: 6-12 & 25-69

Impedance: 75 Ω

Power: 6VDC, 150mA

Power Consumption: 80mA (Max)

Dimensions: 305(W) x 230(H) x 20(D)mm

Distributed by:
TechBrands by Electus Distribution Pty. Ltd.
320 Victoria Rd, Rydalmere
NSW 2116 Australia
Ph: 1300 738 555
Int'l: +61 2 8832 3200
Fax: 1300 738 500
www.techbrands.com