



Installation and Operation Manual

Blackmagic

Audio Monitor 12G

January 2020

English, 日本語, Français, Deutsch, Español, 中文,
한국어, Русский, Italiano, Português and Türkçe.

Languages

To go directly to your preferred language, simply click on the hyperlinks listed in the contents below.

English	3
日本語	24
Français	46
Deutsch	68
Español	90
中文	112
한국어	134
Русский	156
Italiano	178
Português	200
Türkçe	222



Welcome

Thank you for purchasing a Blackmagic Audio Monitor for your production needs!

We hope you share our dream for the television industry to become a truly creative industry by allowing anyone to have access to the highest quality video equipment.

Audio monitoring is crucial for any video production workflow, whether it's broadcast, post production or live production. Blackmagic Audio Monitor gives you all the features of professional audio monitors in a compact rack mount design. You can connect to virtually all types of audio equipment for high quality monitoring. The original Blackmagic Audio Monitor supports 6G-SDI for connecting Ultra HD video up to 30 frames per second. Blackmagic Audio Monitor 12G supports 12G-SDI for connecting Ultra HD video up to 60 frames per second and also supports level A and B 3G-SDI video signal inputs.

This instruction manual contains all the information you need to start using your Blackmagic Audio Monitor.

Please check the support page on our web site at www.blackmagicdesign.com for the latest version of this manual and updates to your Blackmagic Audio Monitor's internal software. Keeping your internal software up to date will always ensure you get all the latest features. When downloading software, please register with your information so we can keep you updated when new software is released. We are constantly working on new features and improvements, so we would love to hear from you!

A stylized, cursive signature of Grant Petty in black ink.

Grant Petty

CEO Blackmagic Design

Contents

Blackmagic Audio Monitor 12G

Getting Started	4
Introducing Blackmagic Audio Monitor	4
Plugging in Audio	4
Selecting your Audio Source	5
Connecting Video Outputs	5
Using Blackmagic Audio Monitor	6
Using the Control Panel	6
LCD	6
Audio Level Meters	6
Solo Left and Solo Right	7
Channel Up and Channel Down	7
Input	8
Mute	8
Volume	8
Audio Monitor Setup	9
Blackmagic Audio Monitor Setup	9
macOS Installation	9
Windows Installation	9
Updating the Internal Software	9
Meter Tab	10
Configure Tab	12
Changing Network Settings	12
Changing Network Settings via USB	12
Installing the optional Blackmagic Dolby® Decoder Module	13
Installing the Module	13
Confirming Dolby Audio	14
Developer Information	15
Controlling Blackmagic Audio Monitor 12G using Telnet	15
Blackmagic Audio Monitor 12G Ethernet Protocol V1.0	15
Help	19
Regulatory Notices	20
Safety Information	21
Warranty	22

Getting Started

Introducing Blackmagic Audio Monitor

Blackmagic Audio Monitor and Blackmagic Audio Monitor 12G are single rack real time audio monitoring solutions that can be used with a variety of video and audio sources in live, post production and broadcast environments.

Blackmagic Audio Monitor connects to SD/HD/3G/6G-SDI, digital AES/EBU and analog audio equipment to ensure outputs have the correct audio levels. The 12G model supports 12G-SDI so you can connect Ultra HD video up to 60 frames per second. Left and right channel LED level meters let you see where your audio is peaking and the built in LCD shows your SDI video input plus important information such as input connection type, video format, frame rate, audio channels and volume level.

You can monitor up to 16 channels of embedded SDI audio, or use XLR connectors for balanced analog and AES/EBU digital audio. There are also RCA connectors so you can plug in consumer equipment such as HiFi systems and iPods.

Your Blackmagic Audio Monitor includes two high quality internal full range speakers and two sub woofers that give you a wide range of frequencies for clear and deep sound reproduction, or you can connect a headset for confident sound monitoring that is great if you are in a noisy environment!

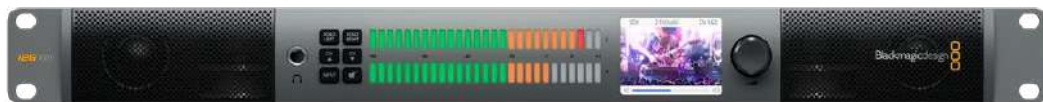

The front panel of Blackmagic Audio Monitor 12G



The rear panel of Blackmagic Audio Monitor 12G

Plugging in Audio

Blackmagic Audio Monitor supports virtually all types of audio equipment! If you want to connect SDI signals in SD, HD, 2K or even Ultra HD, you can plug in via the SDI input using a standard BNC connector. The 12G model supports level A and B 3G-SDI video signal inputs.

Plug in using XLR connectors if you want to monitor digital AES/EBU audio from equipment including disk recorders and digital audio consoles, or from analog equipment such as audio mixers or Betacam SP decks. Analog audio from consumer equipment such as VCRs and DVD players can be connected using standard RCA connectors. You can also connect headphones via the 1/4" TRS headphone jack when you need to listen to your audio privately without disturbing others.

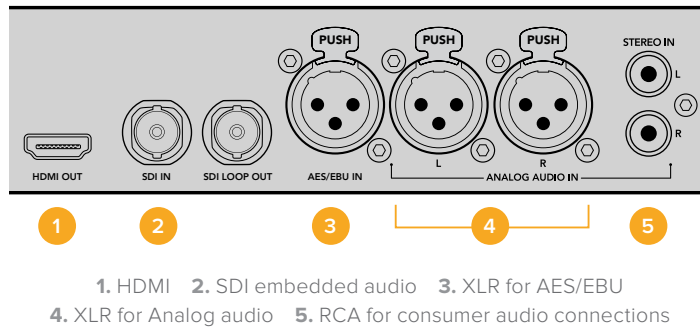

Selecting your Audio Source

After plugging in your audio equipment to Blackmagic Audio Monitor, all you need to do is select your connection by pressing the INPUT button on the control panel. When your input is selected and audio is present, you'll notice the audio level meter LEDs illuminated. The audio level meter consists of 2 rows of colored LEDs and are brightly lit so you can easily confirm your audio input is working.

The INPUT button lets you cycle through your audio connections and you can see them on the color LCD with information including input type, audio channels and volume level. That's all you need to do to monitor audio with Blackmagic Audio Monitor.

Connecting Video Outputs

If you need video as well as audio monitoring, Blackmagic Audio Monitor's video outputs let you monitor video with audio on a large screen, or connect to more video equipment.

The HDMI output and SDI loop output can be used to monitor video and embedded audio. You can connect to SD, HD, 2K and even Ultra HD capture devices such as DeckLink 4K Extreme with a single SDI cable. Connect video with embedded audio to recording decks such as HyperDeck Studio via SD/HD-SDI or the latest Ultra HD display and projectors via HDMI.

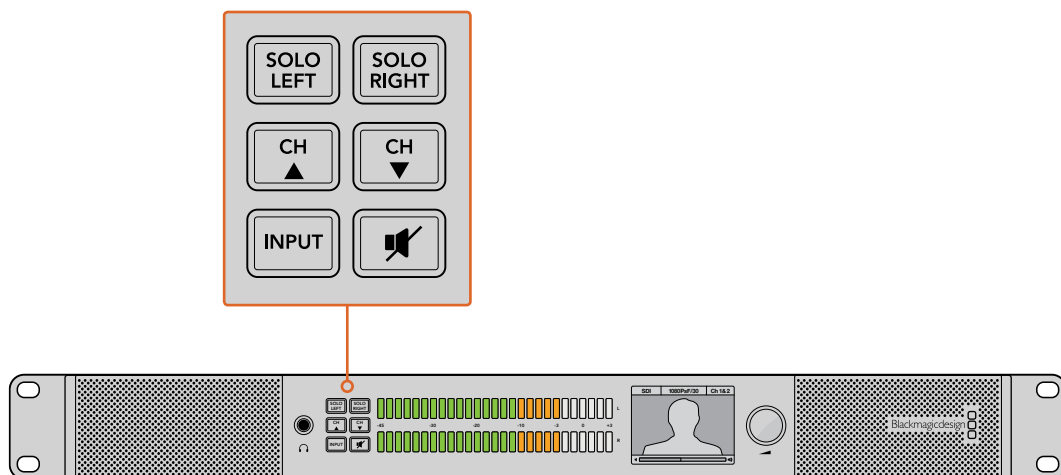

The selection buttons allow you to choose which input you wish to monitor, isolate left and right stereo channels, move up or down through available audio channels, and mute the speakers or headphones.

Using Blackmagic Audio Monitor

Using the Control Panel

Blackmagic Audio Monitor's control panel provides fast access to critical functions and status.

LCD

The built in color LCD features a text overlay that displays important status information, such as your selected input, the video format if SDI is connected, selected audio channels, and the volume level for your speakers or headphones. The LCD will also display any incoming SDI video signal. If there is no SDI video detected, a music icon will be displayed.

The following information is displayed for each selected input:

SDI input

SDI, video format, selected audio channels.

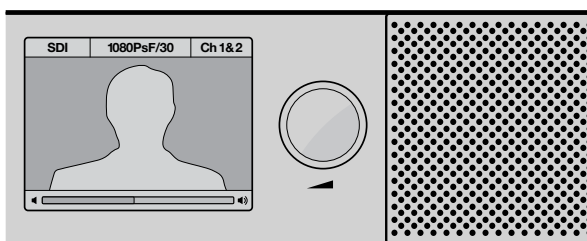

The color LCD displays audio and video information including connection type, video format, selected audio channels and volume level.

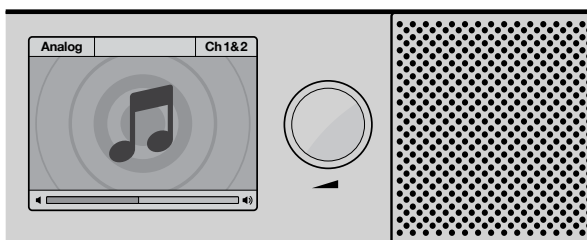

A music icon is displayed on the LCD unless monitoring an SDI video signal.

Balanced AES/EBU XLR input

AES/EBU, selected audio channels.

Balanced XLR analog inputs

Analog, selected audio channels.

Unbalanced RCA analog inputs

HiFi, selected audio channels.

Audio Level Meters

Blackmagic Audio Monitor's level meters feature two banks of green, orange and red LEDs that show the strength of your audio levels. If all LEDs are lit, your audio levels are too high and are clipping.

The behaviour of the audio level meters will change depending on which meter type setting you have selected in the Audio Monitor Setup utility. If you are using VU metering, adjust the output levels on your audio equipment so the meter peaks at the 0dB indicator on the control panel. This maximizes the signal to noise ratio and ensures your audio is at the highest quality. If your audio peaks beyond the 0dB indicator there is a high risk of sound distortion.

Please refer to the 'Audio Monitor Setup' section for information on installing Blackmagic Audio Monitor Setup and setting the level meter types.

Solo Left and Solo Right

These buttons let you isolate left and right channel audio so you can listen for any potential audio problems in each channel independently.

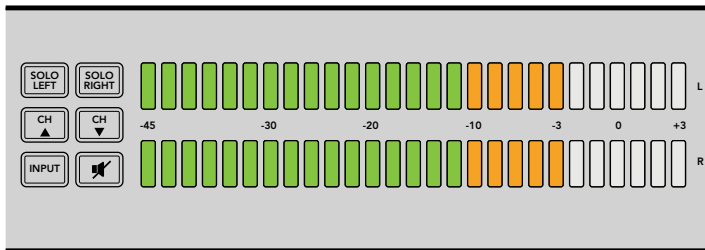

Selecting Solo Left deactivates the right audio channel. The audio level meter will continue to display both levels.

To monitor left channel audio:

- 1 Press the Solo Left button. The button will become backlit green and your audio will play through the left speaker only.
- 2 Press Solo Left again to return to stereo audio monitoring.

To monitor right channel audio:

- 1 Press the Solo Right button. The button will become backlit green and your audio will play through the right speaker only.
- 2 Press Solo Right again to return to stereo audio monitoring.

Channel Up and Channel Down

These buttons let you cycle through the embedded audio channels in your SDI connection. For 3G-SDI, this includes up to 16 channels, or 8 pairs. Press the channel 'up' and 'down' buttons to move up or down through the embedded SDI audio channels.

Blackmagic Audio Monitor 12G supports 12G-SDI which includes up to 64 channels of audio, or 32 pairs of channels. Press and hold the arrow up or down buttons to quickly scroll through them.

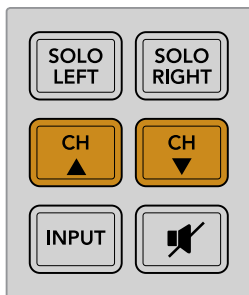

Input

Repeatedly pressing the INPUT button cycles through the SDI, AES/EBU, Analog and HiFi inputs so you can select which video and audio equipment you wish to monitor.

The selected audio input can be listened to via the built in speakers, plus you can monitor the audio on CH 1 & 2 of the HDMI output.

NOTE The HDMI output will display black video when the analog, AES/EBU or HiFi inputs are selected. The SDI Loop output always outputs the video and audio connected to the SDI input.

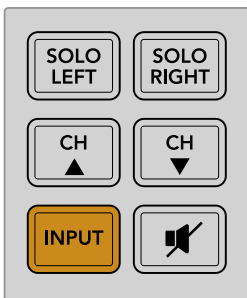

Mute

This button mutes Blackmagic Audio Monitor's control panel speakers and headphones. Muting the audio will not affect your audio input and will only affect the speakers and headphones output. Pressing the MUTE button again will restore audio to the control panel speakers or headphones. Alternatively, increasing the volume will also restore audio.

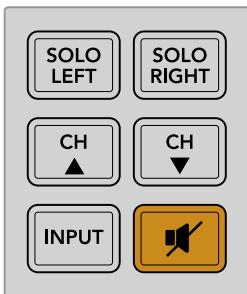

Volume

This knob adjusts the volume for the speakers or headphones independently. Volume level is displayed on the built in LCD. When headphones are connected, Blackmagic Audio Monitor's speakers will mute and audio is outputted via headphones. Volume can easily be adjusted up or down by turning the volume knob clockwise or counterclockwise.

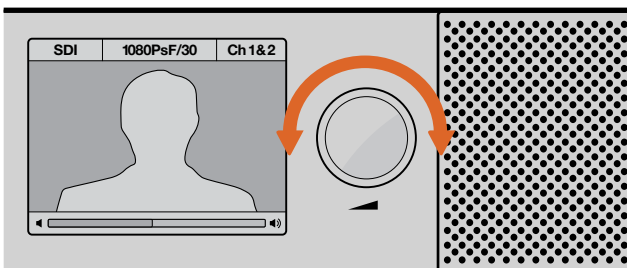

The volume level is displayed on the control panel LCD.

Audio Monitor Setup

Blackmagic Audio Monitor Setup

The Blackmagic Audio Monitor Setup utility is used to set your desired audio level meter type, plus update the internal software on your Blackmagic Audio Monitor.

The setup utility can be installed using the included SD card, but we recommend downloading the latest version from the Blackmagic Design support center at www.blackmagicdesign.com/support.

When the original Blackmagic Audio Monitor is connected to a computer via USB, you can change the configure settings and update the internal software using the setup utility. On Blackmagic Audio Monitor 12G, you can also update the unit and change settings via Ethernet, however, to change network settings you will need to be connected via USB.

Blackmagic Audio Monitor Setup runs on macOS Mojave 10.14 or later and Windows 10.

macOS Installation

- 1 Double click the installer file from the supplied media or from your downloads folder if you downloaded the software from the Blackmagic Design website.
- 2 Follow the install prompts and macOS will automatically install the software.

Windows Installation

- 1 Double click the installer file from the supplied media, or downloads folder if you downloaded the software from the Blackmagic Design website.
- 2 Follow the install prompts and accept the terms in the License Agreement and Windows will automatically install the software.

Updating the Internal Software

- 1 Connect your Blackmagic Audio Monitor to your computer via USB or Ethernet.
- 2 Open Blackmagic Audio Monitor Setup.
- 3 Click the configuration icon and the utility will inform you if an update is required.
- 4 If an update is required, click the 'update' button and allow the software installation to complete.



Click the Update button to apply the internal software update.



A progress bar will show you the status of your update.

- 5 Click the 'close' button when the update is finished.

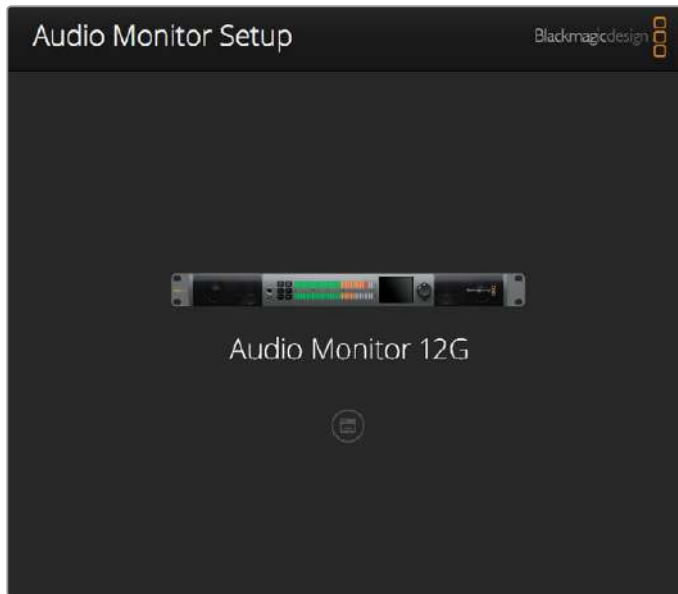

Update your Blackmagic Audio Monitor's internal software and change configuration settings using the Blackmagic Audio Monitor Setup utility

Meter Tab

With the setup utility open, click on the configuration icon to reveal the audio level meters settings. You can select from VU, PPM or loudness meter types with EBU and BBC measurement scales. While the VU meter has now become standardized, PPM and loudness meters provide scaling systems and measurements for perceived loudness. The table on the following page shows the supported audio level meters and measurement scale combinations.

Meter Type	Scale Type	Measurement Scale	How to Use
VU	–	-45 to +3	Printed on unit
PPM	EBU	-12 to +12	Stick-on label
PPM	BBC	1 to 7	Stick-on label
Loudness	EBU +9	-18 to +9	Stick-on label
Loudness	EBU +18	-36 to +18	Stick-on label
Loudness	Full Scale +9	-41 to -14	Stick-on label
Loudness	Full Scale +18	-59 to -5	Stick-on label

VU

This meter averages out short peaks and troughs in your audio signal. It's mostly used to monitor peaks in a signal, however, because of its averaging capability it can also be used to monitor the perceived loudness of your audio.

PPM

This meter displays a "peak hold" feature that momentarily holds the signal peaks, and a slow fall back so you can easily see where your audio is peaking.

Loudness

This meter displays the subjective quality of loudness in your audio signal. Today's broadcast standards include loudness metering for consistent audio loudness levels.

The VU and PPM meters feature a selectable reference level of -18dB or -20dB so you can monitor your audio to suit different international broadcasting standards.

Your Blackmagic Audio Monitor's LED reference behavior will change with each selected meter type. Stick-on labels with accurate dB reference scales are provided with your Blackmagic Audio Monitor to help you easily identify where your audio is peaking. To apply the stick on labels, simply peel and stick the desired scale in between the colored LED meters and over the current VU scale markings.

Two labels are provided for each audio level meter type and measurement scale. Label sheets are also available from your local Blackmagic Design support office. Visit the Blackmagic Design support center at www.blackmagicdesign.com/support to find your local support team.



To choose a meter setting to display on your Blackmagic Audio Monitor, click on your desired meter type and then click 'save'.

EBU PPM									
-12	-8	-4	0	+4	+8	+12			
-12	-8	-4	0	+4	+8	+12			
BBC PPM									
1	2	3	4	5	6	7			
1	2	3	4	5	6	7			
Loudness Units EBU +9dB									
-18	-15	-12	-9	-6	-3	0	+3	+6	+9
-18	-15	-12	-9	-6	-3	0	+3	+6	+9
Loudness Units Fullscale +9dB									
-41	-38	-35	-32	-29	-26	-23	-20	-17	-14
-41	-38	-35	-32	-29	-26	-23	-20	-17	-14
Loudness Units EBU +18dB									
-36	-30	-24	-18	-12	-6	0	+6	+12	+18
-36	-30	-24	-18	-12	-6	0	+6	+12	+18
Loudness Units Fullscale +18dB									
-59	-53	-47	-41	-35	-29	-23	-17	-11	-5
-59	-53	-47	-41	-35	-29	-23	-17	-11	-5

Stick-on labels are provided so you can accurately identify where your audio is peaking for each meter type.

Configure Tab

Blackmagic Audio Monitor 12G has an additional 'configure' tab that lists the software version number and contains your Blackmagic Audio Monitor's network settings. You can also label your unit with a custom name. Naming the unit helps you quickly locate it when connected remotely.

Naming your Blackmagic Audio Monitor 12G

To name your Blackmagic Audio Monitor 12G:

- 1 Click on the 'configure' tab.
- 2 In the 'details' setting, click the 'name' text box and enter a new label.
- 3 Click 'save'.



Changing Network Settings

Accessing your Blackmagic Audio Monitor 12G over a network is the easiest way to manage multiple units. You can do this using Blackmagic Audio Monitor Setup. By default, your Blackmagic Audio Monitor 12G is configured to automatically acquire a network address, making it easy to immediately select it from the setup utility home screen.

If you are having trouble finding a Blackmagic Audio Monitor 12G on your network, or you have previously set it to use a static address incompatible with your current network, you may need to change its network settings locally. You can do this via USB.

Changing Network Settings via USB

To change network settings via USB, connect your Blackmagic Audio Monitor 12G to a computer running the Blackmagic Audio Monitor Setup utility with a USB cable. You can find your Blackmagic Audio Monitor 12G's USB connector on its rear panel. Once connected, select your Audio Monitor 12G from the Blackmagic Audio Monitor Setup utility home screen, and navigate to the 'configure' tab. Here you can toggle between dynamic and static network addresses. If you select a static IP, you can manually configure the address, subnet mask, and gateway.

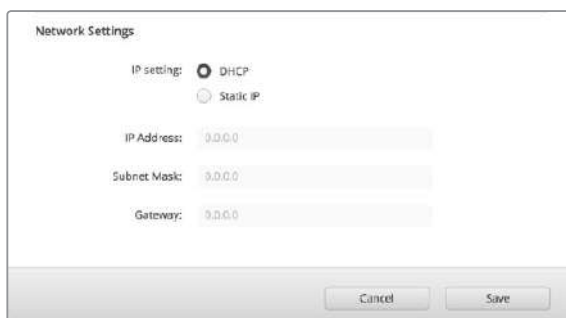

Installing the optional Blackmagic Dolby® Decoder Module

Dolby has now discontinued the Dolby decoder module, however if you have the module for the original Blackmagic Audio Monitor and would like to install it, please follow the instructions on this page.

NOTE Blackmagic Audio Monitor 12G does not support the optional Dolby decoder module.

WARNING

Ensure that power is disconnected from your Blackmagic Audio Monitor before installing the Dolby decoder module, as installation requires the removal of the chassis lid to access the motherboard. This process should only be performed by qualified individuals. Precautions should also be taken to reduce the risk of electrostatic discharge while installing the module.

Installing the Module

By installing a Blackmagic Dolby decoder module you can monitor Dolby Digital or Dolby E audio used in modern film and television productions. Dolby 5.1 surround sound is encoded with front left and right channels, rear surround left and right channels, a center channel, plus one channel for low bass frequencies.

The Dolby decoder is a 72 pin SIMM module that is easily installed into the empty SIMM slot on Blackmagic Audio Monitor's motherboard.

To install the Blackmagic Dolby decoder module:

- 1 Ensure Blackmagic Audio Monitor's power is unplugged.
- 2 Unscrew all Blackmagic Audio Monitor's 21 lid screws using a Phillips head screwdriver. Remove the lid.
- 3 Hold the Blackmagic Dolby decoder module with its contacts facing the empty SIMM slot. The SIMM's keyway needs to be aligned with the slot key or the SIMM will not seat.
- 4 Gently insert the module into the SIMM slot until the contacts are firmly seated.
- 5 Lean the module towards the rear of Blackmagic Audio Monitor until the metal clips fasten to each side of the module.
- 6 Replace Blackmagic Audio Monitor's lid and screw in the 21 lid screws.

After installing the Blackmagic Dolby decoder module, place the supplied Dolby sticker on Blackmagic Audio Monitor's back panel near the warning label so you can easily see the Dolby module has been installed.

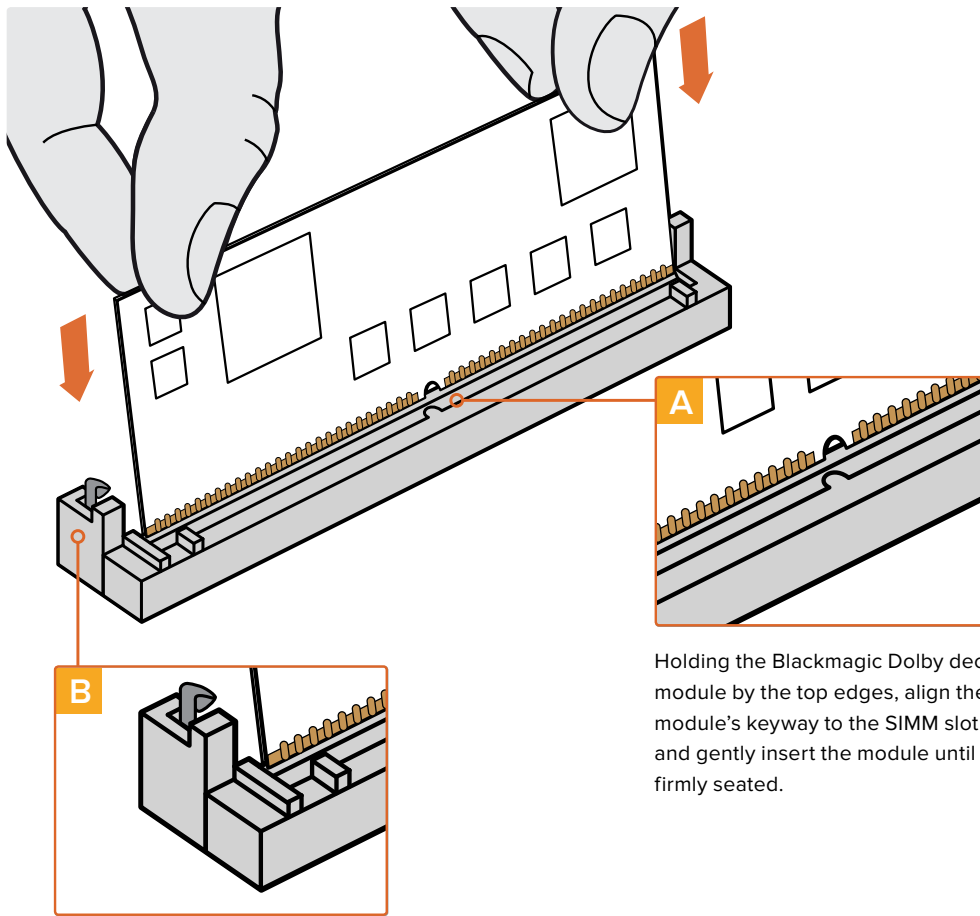

Holding the Blackmagic Dolby decoder module by the top edges, align the module's keyway to the SIMM slot key and gently insert the module until it is firmly seated.

Lean the Blackmagic Dolby decoder module towards the rear of the chassis until the metal clips fasten to both sides

Confirming Dolby Audio

When Dolby encoded audio is detected by Blackmagic Audio Monitor the Dolby logo will appear on the top right corner of the control panel LCD. You can monitor 4 pairs of Dolby surround channels by pressing the control panel channel up and down buttons.

Developer Information

Controlling Blackmagic Audio Monitor 12G using Telnet

The Blackmagic Audio Monitor 12G Ethernet Protocol gives you the freedom to build your own custom control solutions for your Blackmagic Audio Monitor 12G. For example, you can create your own software application or web interface to control your Blackmagic Audio Monitor 12G via Ethernet from your computer.

The first step is to connect your Blackmagic Audio Monitor 12G to your computer via Ethernet. You can do this by connecting to the same network your computer is connected to, or you can connect Blackmagic Audio Monitor 12G directly to your computer.

NOTE If Blackmagic Audio Monitor 12G is connected directly to your computer, set your computer to a manual static IP address. Set the first three blocks of numbers in the IP address to match your Blackmagic Audio Monitor 12G and set the subnet mask to 255.255.255.0. You can leave the gateway or router setting blank as it will not be used in a direct connection between your computer and Blackmagic Audio Monitor 12G.

If your network settings are set correctly, you can now open the Terminal application on macOS, or enable Telnet command line utilities on Windows and enter Blackmagic Audio Monitor 12G Ethernet Protocol commands. These commands can be programmed into your application and triggered by related items on a custom user interface of your own design.

Using Telnet on macOS and Windows

- 1 On macOS, open the Terminal application which is located within the Applications > Utilities folder.

To open the command prompt in Windows, click on the 'start' menu and type 'cmd' in the search bar. Press 'enter'.

- 2 Type in "telnet" and a space followed by the IP address of your computer, then another space and "9996", which is the default port number for Blackmagic Audio Monitor 12G.

For example:

```
telnet 192.168.25.253 9996
```

Press 'enter'. The Protocol Preamble screen will appear.

Blackmagic Audio Monitor 12G Ethernet Protocol V1.0

Summary

The Blackmagic Audio Monitor 12G Ethernet Protocol is a text based protocol that is accessed by connecting to TCP port 9996 on a Blackmagic Audio Monitor 12G.

The Blackmagic Audio Monitor 12G sends information in blocks which each have an identifying header in all-caps, followed by a full-colon. A block spans multiple lines and is terminated by a blank line.

Each line in the protocol is terminated by a new line character.

Upon connection, the Blackmagic Audio Monitor 12G sends a complete dump of the state of the device. After the initial status dump, status updates are sent every time the Blackmagic Audio Monitor 12G status changes.

To be resilient to future protocol changes, clients should ignore blocks they do not recognize, up to the trailing blank line. Within existing blocks, clients should ignore lines they do not recognize.

Legend

↵ line feed or carriage return
... and so on

Version 1.0 of the Blackmagic Audio Monitor 12G Ethernet Protocol was released with Blackmagic Audio Monitor 12G 3.0 software.

Protocol Preamble

The first block sent by the Blackmagic Audio Monitor 12G is always the protocol preamble:

```
PROTOCOL PREAMBLE:  
Version: 1.0
```

The version field indicates the protocol version. When the protocol is changed in a compatible way, the minor version number will be updated. If incompatible changes are made, the major version number will be updated.

Device Information

The next block contains general information about the connected Blackmagic Audio Monitor 12G device. If a device is connected, the Blackmagic Audio Monitor 12G will report the attributes of the Blackmagic Audio Monitor 12G:

```
AUDIOMONITOR DEVICE:↵  
Model: Blackmagic Audio Monitor 12G  
Label: Blackmagic Audio Monitor 12G
```

Only the label can be modified.

```
AUDIOMONITOR DEVICE:↵  
Label: My new name↵  
↵
```

The response will be

```
ACK:  
AUDIOMONITOR DEVICE:  
Label: My new name
```

The next block will show the network settings which can only be changed via the Blackmagic Audio Monitor Setup utility when connected over USB. This is for information only.

```
NETWORK:  
Dynamic IP: 1  
Current address: 0.0.0.0  
Current subnet: 0.0.0.0  
Current gateway: 0.0.0.0
```

The next block is the meter type.

```
AUDIO METER:  
Meter Mode: VU (-20dBFS Ref)
```

This can be changed to VU (-20dBFS Ref), VU (-18dBFS Ref), PPM EBU (-20dBFS Ref), PPM EBU (-18dBFS Ref), PPM BBC (-20dBFS Ref), PPM BBC (-18dBFS Ref), Loudness (EBU +9 scale) or Loudness (EBU +18 scale)

```
AUDIO METER:↵  
Meter Mode: Loudness (EBU +18 scale)↵  
↵
```

The response will be

```
ACK:  
AUDIO METER:  
Meter Mode: Loudness (EBU +18 scale)
```

The next block is the input type.

```
AUDIO INPUT:  
Routing: Speaker Stereo SDI Stereo 1-2
```

This can be changed to SDI Stereo 3-4, SDI Stereo 5-6, SDI Stereo 7-8, SDI Stereo 9-10, SDI Stereo 11-12, SDI Stereo 13-14, SDI Stereo 15-16, XLR AES/EBU Stereo 1-2, XLR Analog Stereo or RCA Stereo

```
AUDIO INPUT:↵  
Routing: Speaker Stereo XLR AES/EBU Stereo 1-2↵  
↵
```

The response will be

```
ACK:  
AUDIO INPUT:  
Routing: Speaker Stereo XLR AES/EBU Stereo 1-2
```

The next block is the audio output state. This indicates the current headphone and speaker volume settings as well as the state of the mute and solo buttons.

```
AUDIO OUTPUT:  
Gain: Speaker Stereo 0  
Gain: Headphone Stereo 0  
Mute: false  
Solo: Off
```

The volume gain settings can be set between 0 and 255. Mute can be true or false and Solo can be Off, Left or Right

```
AUDIO OUTPUT:↵  
Gain: Speaker Stereo 125↵  
Solo: Right↵  
↵
```

The response will be

```
ACK:  
AUDIO OUTPUT:  
Gain: Speaker Stereo 125  
Solo: Right
```

Checking the Connection

While the connection to the Blackmagic Audio Monitor 12G is established, a client may send a special no-operation command to check that the Blackmagic Audio Monitor 12G is still responding:

```
PING:↵  
↵
```

If the Blackmagic Audio Monitor 12G is responding, it will respond with an ACK message as for any other recognized command.

Checking valid Protocol Commands

While the connection to the Blackmagic Audio Monitor 12G is established, a client may send a special HELP command to obtain a list of supported Telnet commands:

```
HELP:↵  
↵  
AUDIOMONITOR DEVICE:  
Model: <label> [read only]  
Label: <label>  
Unique ID: <label> [read only]  
  
NETWORK:  
Dynamic IP: <boolean> [read only]  
Current address: <IP_address> [read only]  
Current subnet: <IP_address> [read only]  
Current gateway: <IP_address> [read only]  
  
AUDIO METER:  
Meter Mode: <enum> -> <enum> = <"VU (-20dBFS Ref)" | "VU (-18dBFS Ref)" | "PPM  
EBU (-20dBFS Ref)" | "PPM EBU (-18dBFS Ref)" | "PPM BBC (-20dBFS Ref)" | "PPM  
BBC (-18dBFS Ref)" | "Loudness (EBU +9 scale)" | "Loudness (EBU +18 scale)">;  
  
AUDIO INPUT:  
Routing: <enum1> <enum2> -> <enum1> = <"Speaker Stereo">; <enum2> = <"SDI  
Stereo 1-2" | "SDI Stereo 3-4" | "SDI Stereo 5-6" | "SDI Stereo 7-8" | "SDI  
Stereo 9-10" | "SDI Stereo 11-12" | "SDI Stereo 13-14" | "SDI Stereo 15-16" |  
"XLR AES/EBU Stereo 1-2" | "XLR Analog Stereo" | "RCA Stereo">;  
  
AUDIO OUTPUT:  
Gain: <enum> <integer> -> <enum> = <"Speaker Stereo" | "Headphone Stereo">;  
<integer> = <0..255>;  
  
Mute: <boolean> -> <boolean> = <true | false>;  
  
Solo: <enum> -> <enum> = <"Off" | "Left" | "Right">;
```

Help

Getting Help

The fastest way to obtain help is to go to the Blackmagic Design online support pages and check the latest support material available for your Blackmagic Audio Monitor.

Blackmagic Design Online Support Pages

The latest manual, software and support notes can be found at the Blackmagic Design support center at www.blackmagicdesign.com/support.

Blackmagic Design Forum

The Blackmagic Design forum on our website is a helpful resource you can visit for more information and creative ideas. This can also be a faster way of getting help as there may already be answers you can find from other experienced users and Blackmagic Design staff which will keep you moving forward. You can visit the forum at <https://forum.blackmagicdesign.com>

Contacting Blackmagic Design Support

If you can't find the help you need in our support material or on the forum, please use the "Send us an email" button on the support page to email a support request. Alternatively, click on the "Find your local support team" button on the support page and call your nearest Blackmagic Design support office.

Checking the Software Version Currently Installed

To check which version of Blackmagic Audio Monitor Setup is installed on your computer, open the About Blackmagic Audio Monitor Setup window.

- On macOS, open Blackmagic Audio Monitor Setup from the Applications folder. Select About Blackmagic Audio Monitor Setup from the application menu to reveal the version number.
- On Windows 10, open Blackmagic Audio Monitor Setup from the Blackmagic Audio Monitor Setup tile on your Start page. Click on the Help menu and select About Blackmagic Audio Monitor Setup to reveal the version number.

How to Get the Latest Software Updates

After checking the version of Blackmagic Audio Monitor Setup installed on your computer, please visit the Blackmagic Design support center at www.blackmagicdesign.com/support to check for the latest updates. While it is usually a good idea to run the latest updates, it is wise to avoid updating any software if you are in the middle of an important project.

Regulatory Notices

Disposal of Waste of Electrical and Electronic Equipment Within the European Union.



The symbol on the product indicates that this equipment must not be disposed of with other waste materials. In order to dispose of your waste equipment, it must be handed over to a designated collection point for recycling. The separate collection and recycling of your waste equipment at the time of disposal will help conserve natural resources and ensure that it is recycled in a manner that protects human health and the environment. For more information about where you can drop off your waste equipment for recycling, please contact your local city recycling office or the dealer from whom you purchased the product.



This equipment has been tested and found to comply with the limits for a Class A digital device, pursuant to Part 15 of the FCC rules. These limits are designed to provide reasonable protection against harmful interference when the equipment is operated in a commercial environment. This equipment generates, uses, and can radiate radio frequency energy and, if not installed and used in accordance with the instructions, may cause harmful interference to radio communications. Operation of this product in a residential area is likely to cause harmful interference, in which case the user will be required to correct the interference at personal expense.

Operation is subject to the following two conditions:

- 1 This device may not cause harmful interference.
- 2 This device must accept any interference received, including interference that may cause undesired operation.

ISED Canada Statement

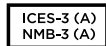

This device complies with Canadian standards for Class A digital apparatus.

Any modifications or use of this product outside its intended use could void compliance to these standards.

Connection to HDMI interfaces must be made with high quality shielded HDMI cables.

This equipment has been tested for compliance with the intended use in a commercial environment. If the equipment is used in a domestic environment, it may cause radio interference.

Safety Information

For protection against electric shock, the equipment must be connected to a mains socket outlet with a protective earth connection. In case of doubt contact a qualified electrician.

To reduce the risk of electric shock, do not expose this equipment to dripping or splashing.

Product is suitable for use in tropical locations with an ambient temperature of up to 40°C.

Ensure that adequate ventilation is provided around the product and that it is not restricted.

When rack mounting, ensure that the ventilation is not restricted by adjacent equipment.

No operator serviceable parts inside product. Refer servicing to your local Blackmagic Design service center.



Use only at altitudes not more than 2000m above sea level.

State of California statement

This product can expose you to chemicals such as trace amounts of polybrominated biphenyls within plastic parts, which is known to the state of California to cause cancer and birth defects or other reproductive harm.

For more information go to www.P65Warnings.ca.gov.

Warranty

12 Month Limited Warranty

Blackmagic Design warrants that this product will be free from defects in materials and workmanship for a period of 12 months from the date of purchase. If a product proves to be defective during this warranty period, Blackmagic Design, at its option, either will repair the defective product without charge for parts and labor, or will provide a replacement in exchange for the defective product.

In order to obtain service under this warranty, you the Customer, must notify Blackmagic Design of the defect before the expiration of the warranty period and make suitable arrangements for the performance of service. The Customer shall be responsible for packaging and shipping the defective product to a designated service center nominated by Blackmagic Design, with shipping charges pre paid. Customer shall be responsible for paying all shipping charges, insurance, duties, taxes, and any other charges for products returned to us for any reason.

This warranty shall not apply to any defect, failure or damage caused by improper use or improper or inadequate maintenance and care. Blackmagic Design shall not be obligated to furnish service under this warranty: a) to repair damage resulting from attempts by personnel other than Blackmagic Design representatives to install, repair or service the product, b) to repair damage resulting from improper use or connection to incompatible equipment, c) to repair any damage or malfunction caused by the use of non Blackmagic Design parts or supplies, or d) to service a product that has been modified or integrated with other products when the effect of such a modification or integration increases the time or difficulty of servicing the product. THIS WARRANTY IS GIVEN BY BLACKMAGIC DESIGN IN LIEU OF ANY OTHER WARRANTIES, EXPRESS OR IMPLIED. BLACKMAGIC DESIGN AND ITS VENDORS DISCLAIM ANY IMPLIED WARRANTIES OF MERCHANTABILITY OR FITNESS FOR A PARTICULAR PURPOSE. BLACKMAGIC DESIGN'S RESPONSIBILITY TO REPAIR OR REPLACE DEFECTIVE PRODUCTS IS THE WHOLE AND EXCLUSIVE REMEDY PROVIDED TO THE CUSTOMER FOR ANY INDIRECT, SPECIAL, INCIDENTAL OR CONSEQUENTIAL DAMAGES IRRESPECTIVE OF WHETHER BLACKMAGIC DESIGN OR THE VENDOR HAS ADVANCE NOTICE OF THE POSSIBILITY OF SUCH DAMAGES. BLACKMAGIC DESIGN IS NOT LIABLE FOR ANY ILLEGAL USE OF EQUIPMENT BY CUSTOMER. BLACKMAGIC IS NOT LIABLE FOR ANY DAMAGES RESULTING FROM USE OF THIS PRODUCT. USER OPERATES THIS PRODUCT AT OWN RISK.

© Copyright 2020 Blackmagic Design. All rights reserved. 'Blackmagic Design', 'DeckLink', 'HDLink', 'Workgroup Videohub', 'Multibrige Pro', 'Multibrige Extreme', 'Intensity' and 'Leading the creative video revolution' are registered trademarks in the US and other countries. All other company and product names may be trade marks of their respective companies with which they are associated.



インストール/オペレーション マニュアル

Blackmagic Audio Monitor 12G

2020年1月

日本語



ようこそ

このたびはBlackmagic Audio Monitorをお買い求めいただき誠にありがとうございます。

最高品質のビデオ機器を誰もが利用できるようにすることで、テレビ業界を真にクリエイティブな業界にするという私たちの夢を、ユーザーの皆様と共有できれば幸いです。

オーディオモニタリングは、放送、ポストプロダクション、ライブプロダクションなどの分野に関わらず、ビデオ制作ワークフローにとって欠かせません。Blackmagic Audio Monitorは、コンパクトなラックマウントデザインに、プロ仕様のオーディオモニターのすべての機能を搭載しています。事実上すべてのタイプのオーディオ機器に接続して、高品質モニタリングが行えます。オリジナルのBlackmagic Audio Monitorは、6G-SDIに対応しており、30fpsまでのUltra HDビデオを接続できます。Blackmagic Audio Monitor 12Gは、12G-SDIに対応しており、60fpsまでのUltra HDビデオを接続できます。また、Level AおよびBの3G-SDIビデオ信号入力にも対応しています。

このマニュアルには、Blackmagic Audio Monitorを使用する上で必要な情報がすべて記載されています。

弊社ウェブサイトwww.blackmagicdesign.com/jp のサポートページで、同マニュアルの最新バージョンを確認し、Blackmagic Audio Monitorのソフトウェアをアップデートしてください。ソフトウェアをアップデートすることで、常に最新の機能をお使いいただけます。ソフトウェアをダウンロードする際にユーザー登録をしていただければ、新しいソフトウェアのリリース時にお客様にお知らせいたします。私たちは、常に新機能の開発および製品の改善に努めていますので、ユーザーの皆様からご意見をいただければ幸いです。

A handwritten signature in black ink that reads "Grant Petty". The signature is fluid and cursive.

Blackmagic Design CEO

グラント・ペティ

目次

Blackmagic Audio Monitor 12G

はじめに	27
Blackmagic Audio Monitorについて	27
オーディオの接続	27
オーディオソースの選択	28
ビデオ出力の接続	28
Blackmagic Audio Monitorの使用	29
コントロールパネルの使用	29
LCD	29
オーディオレベル・メーター	29
ソロレフト/ソロライト(SOLO LEFT/SOLO RIGHT)	30
チャンネルアップ/チャンネルダウン(CH▲/CH▼)	30
入力(INPUT)	31
ミュート	31
ボリューム	31
Audio Monitor Setup	32
Blackmagic Audio Monitor Setup	32
macOSにインストール	32
Windowsにインストール	32
内部ソフトウェアのアップデート	32
Meterタブ	33
Configureタブ	35
ネットワーク設定の変更	35
USBでネットワーク設定を変更	35
オプションのBlackmagic Dolby®デコーダーモジュールをインストール	36
モジュールのインストール	36
Dolbyオーディオの確認	37
Developer Information	38
Controlling Blackmagic Audio Monitor 12G using Telnet	38
Blackmagic Audio Monitor 12G Ethernet Protocol V1.0	38
ヘルプ	42
規制に関する警告	43
安全情報	44
保証	45

はじめに

Blackmagic Audio Monitorについて

Blackmagic Audio MonitorおよびBlackmagic Audio Monitor 12Gは、1Uラックサイズのリアルタイムオーディオモニタリング・ソリューションで、ライブ、ポストプロダクション、放送などの環境における様々なビデオ/オーディオソースで使用できます。

Blackmagic Audio Monitorは、SD/HD/3G/6G-SDI、デジタルAES/EBU、アナログオーディオ機器への接続に対応しているため、正確なレベルでオーディオを出力できます。12Gモデルは、12G-SDIに対応しており、60fpsまでのUltra HDビデオを接続できます。LEDレベルメーターの左右のチャンネルでオーディオのピークを確認でき、LCDスクリーンにはSDIビデオ入力に加え、入力信号の接続の種類、ビデオフォーマット、フレームレート、オーディオチャンネル、ボリュームなどの重要な情報が表示されます。

16チャンネルまでのエンベッドSDIオーディオをモニタリングでき、XLRコネクタはバランスアナログおよびAES/EBUデジタルオーディオに使用できます。

Blackmagic Audio Monitorは、2つの高品質フルレンジ・スピーカーおよび2つのサブウーファースを内蔵しており、広域の周波数でクリアかつディープなサウンドを再生できます。さらにヘッドフォンを接続すれば、騒がしい環境でも正確なサウンドモニタリングが可能です！



Blackmagic Audio Monitor 12Gのフロントパネル



Blackmagic Audio Monitor 12Gのリアパネル

オーディオの接続

Blackmagic Audio Monitorは、事実上すべての種類のオーディオ機器に対応しています。SD/HD/2K/Ultra HDのSDI信号は、標準BNC端子を使用してSDI入力に接続できます。12Gモデルは、Level AおよびBの3G-SDIビデオ信号入力にも対応しています。

XLRコネクタを使用すれば、ディスクレコーダーやデジタルオーディオ機器などからのデジタルAES/EBUオーディオのモニタリング、あるいはオーディオミキサーやBetacam SPデッキなどのアナログ機器のモニタリングが可能です。ビデオデッキやDVDプレーヤーなど、民生用機器からのアナログオーディオは標準RCAコネクタで接続できます。周囲の邪魔にならないように1人でモニタリングする場合は、1/4インチTRSヘッドフォンジャックを使用してヘッドフォンを接続できます。

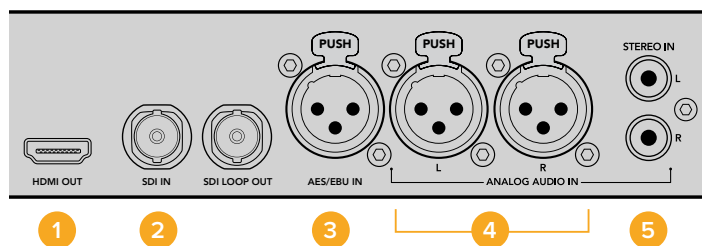

1. HDMI
2. SDIエンベデッドオーディオ
3. AES/EBU用XLR
4. アナログオーディオ用XLR
5. 民生用オーディオ用RCA

オーディオソースの選択

オーディオ機器をBlackmagic Audio Monitorに接続したら、後はコントロールパネル上の「INPUT」ボタンを押して、インターフェースを選択するだけです。接続した入力を選択し、オーディオが入力されると、オーディオレベル・メーターのLEDが点灯します。オーディオレベル・メーターは2列のカラフルなLEDで構成されており、オーディオ入力が簡単に確認できるように明るく光ります。

「INPUT」ボタンでオーディオ入力を選択し、LCDカラースクリーンで、入力信号、オーディオチャンネル、ボリュームなどの情報を確認できます。以上で、Blackmagic Audio Monitorでのオーディオモニタリングの準備は完了です。

ビデオ出力の接続

オーディオモニタリングだけでなく映像も必要な場合は、Blackmagic Audio Monitorのビデオ出力を使用して、オーディオ付きビデオ大型スクリーンでのモニタリングや、他のビデオ機器への接続が可能です。

HDMI出力およびSDIループ出力は、ビデオやエンベデッドオーディオのモニタリングに使用できます。

単一のSDIケーブルで、SD、HD、2K、さらにはDeckLink 4K ExtremeなどのUltra HDキャプチャーデバイスに接続できます。エンベデッドオーディオ付きのビデオを、HyperDeck Studioなどの収録デッキにはSD/HD-SDIで、最新のUltra HDディスプレイやプロジェクターにはHDMIで接続できます。

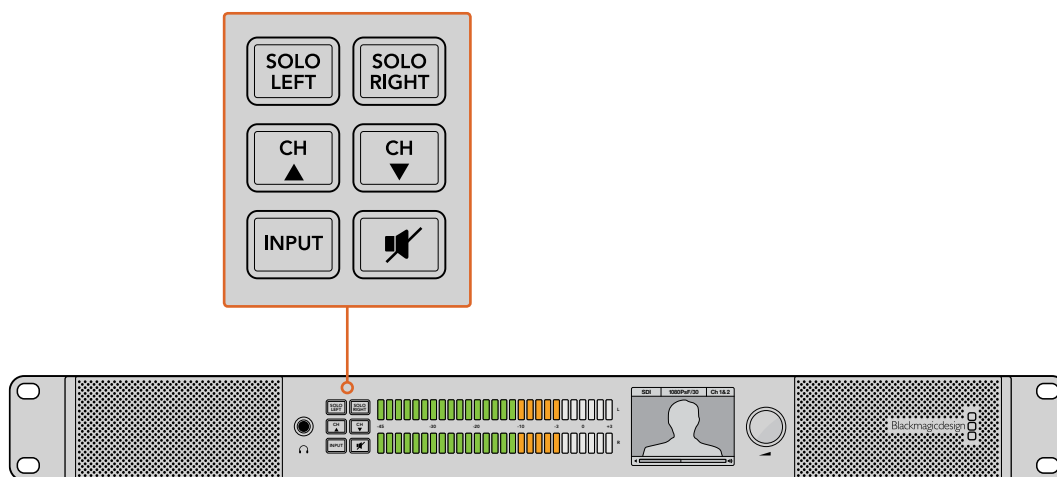

これらのボタンで、モニタリングしたい入力の選択、ステレオオーディオの左右チャンネルのソロ、オーディオチャンネルの選択(ボタンを上下に動かす)、スピーカー/ヘッドフォンのミュートが可能です。

Blackmagic Audio Monitorの使用

コントロールパネルの使用

Blackmagic Audio Monitorのコントロールパネルを使用して、重要な機能やステータスにすばやくアクセスできます。

LCD

内蔵カラーLCDには、選択されている入力、ビデオフォーマット (SDIが接続されている場合)、選択されているオーディオチャンネル、スピーカー/ヘッドフォンのボリュームなど、大切な情報がテキストオーバーレイで表示されます。またLCDには、入力されているあらゆるSDIビデオ信号が表示されます。SDIビデオが検出されない場合は、ミュージック (音符) アイコンが表示されます。

選択した入力に応じて、以下の情報が表示されます：

SDI入力

SDI、ビデオフォーマット、選択オーディオチャンネル

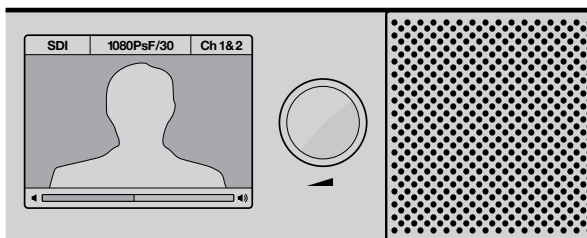

カラーLCDは入力信号、ビデオフォーマット、選択オーディオチャンネル、ボリュームなど、オーディオ/ビデオの情報を表示します。

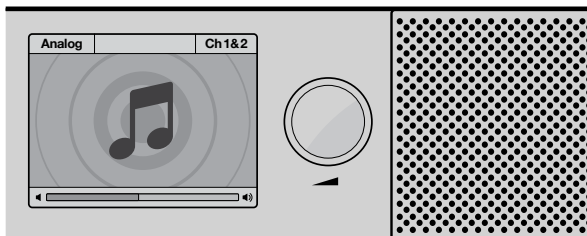

SDIビデオ信号をモニタリングしていない場合はLCDに音符アイコンが表示されます。

バランスAES/EBU XLR入力

AES/EBU、選択オーディオチャンネル

バランスXLRアナログ入力

アナログ、選択オーディオチャンネル

アンバランスRCAアナログ入力

HiFi、選択オーディオチャンネル

オーディオレベル・メーター

Blackmagic Audio Monitorのレベルメーターは、2列のLED (緑、オレンジ、赤) でオーディオレベルを表示します。すべてのLEDが光っている場合、オーディオレベルが高すぎるためクリッピングが発生します。

オーディオレベル・メーターの挙動は、Audio Monitor Setupユーティリティで選択されているメータータイプ設定によって異なります。VUメーターを使用している場合は、メーターのピーク値をコントロールパネルの0dBインジケータに合わせてオーディオ機器の出力レベルを調整してください。これによりS/N比が最大化され、最高品質のオーディオが保証されます。ピーク値が0dBを超えると、ピークノイズが発生するリスクが高くなります。

Blackmagic Audio Monitor Setupのインストールおよびレベルメータータイプの設定に関する詳細は、「Audio Monitor Setup」セクションを参照してください。

ソロレフト/ソロライト (SOLO LEFT/SOLO RIGHT)

これらのボタンで左右のオーディオチャンネルを分離し、個別にモニタリングしてオーディオの問題などを確認できます。

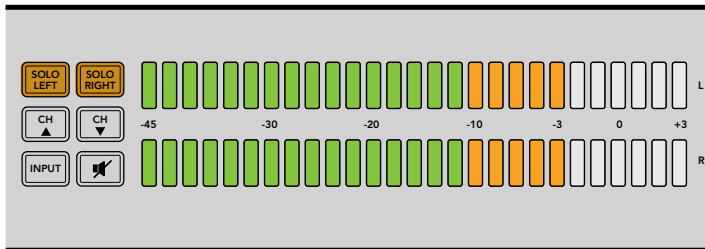

「SOLO LEFT」を選択すると右チャンネルのオーディオはオフになります。オーディオレベル・メーターは、左右両方のレベルを表示します。

左チャンネルのオーディオをモニタリングする:

- 1 「SOLO LEFT」ボタンを押します。ボタンが緑に光り、左のスピーカーのみを通じてオーディオが再生されます。
- 2 「SOLO LEFT」ボタンを再度押すと、ソロが解除され元に戻ります。

右チャンネルのオーディオをモニタリングする:

- 1 「SOLO RIGHT」ボタンを押します。ボタンは緑に光り、右のスピーカーのみを通じてオーディオが再生されます。
- 2 「SOLO RIGHT」ボタンを再度押すと、ソロが解除され元に戻ります。

チャンネルアップ/チャンネルダウン (CH▲/CH▼)

これらのボタンでSDIインターフェースのエンベデッドオーディオチャンネルを選択できます。3G-SDIの場合、最大16チャンネルあるいは8ペアです。チャンネルアップ/チャンネルダウンボタンを押すと、エンベデッドSDIオーディオチャンネルを上下に移動できます。

Blackmagic Audio Monitor 12Gは12G-SDIをサポートしており、これには最大64チャンネルあるいは32ペアのチャンネルが含まれます。上下の矢印ボタンを長押しすると、これらのチャンネルをすばやくスクロールできます。

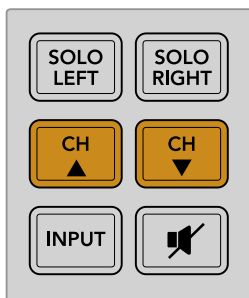

入力(INPUT)

「INPUT」ボタンを繰り返し押すと、SDI、AES/EBU、アナログ、HiFi入力が順に切り替わり、モニタリングしたいビデオ/オーディオ機器を選択できます。

選択したオーディオ入力の内蔵スピーカーで聞くことができ、またHDMI出力のチャンネル1と2でもモニタリングできます。

メモ アナログ、AES/EBU、HiFi入力が選択されている場合、HDMI出力はブラックビデオとして表示されます。SDIループ出力は、SDI入力に接続されているビデオおよびオーディオを常に出力します。

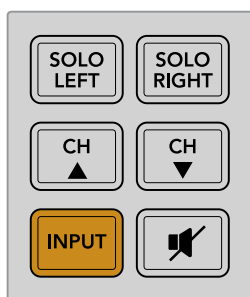

ミュート

ミュートボタンは、Blackmagic Audio Monitorのコントロールパネルのスピーカーおよびヘッドフォンをミュートします。オーディオのミュートはスピーカーおよびヘッドフォンの出力のみに影響します。オーディオ入力に対する影響はありません。ミュートボタンをもう一度押すと、コントロールパネルのスピーカーおよびヘッドフォンのオーディオが元に戻ります。または、ボリュームを上げてもオーディオが元に戻ります。

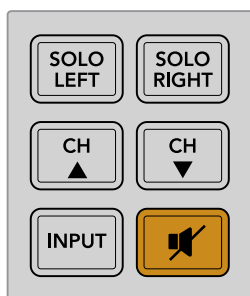

ボリューム

ボリュームノブは、スピーカー/ヘッドフォンのボリュームを個別に調整します。ボリュームレベルはLCDスクリーンに表示されます。ヘッドフォンを接続すると、Blackmagic Audio Monitorのスピーカーはミュートされ、ヘッドフォンからオーディオが出力されます。ボリュームノブを時計回り/反時計回りに回して、簡単にボリュームを調整できます。

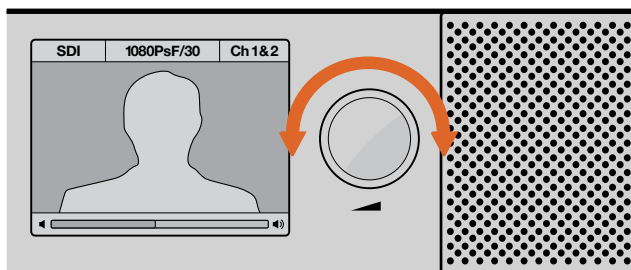

ボリュームレベルがコントロールパネルのLCDに表示されます。

Audio Monitor Setup

Blackmagic Audio Monitor Setup

Blackmagic Audio Monitor Setupは、オーディオレベルメーターの種類の設定や、Blackmagic Audio Monitorの内部ソフトウェアのアップデートに使用します。

Setupユーティリティは同梱のSDカードでインストールできますが、Blackmagic Designサポートセンター www.blackmagicdesign.com/jp/support で最新版をダウンロードすることをお勧めします。

オリジナルのBlackmagic Audio MonitorをUSBでコンピューターに接続している場合、Setupユーティリティを使用して、コンフィギュレーション設定の変更や内部ソフトウェアのアップデートが行えます。Blackmagic Audio Monitor 12Gでは、イーサネット経由でユニットのアップデートおよび設定の変更ができますが、ネットワーク設定を変更するにはUSBで接続されている必要があります。

Blackmagic Audio Monitor Setupは、macOS Mojave 10.14以降のバージョン、またはWindows 10以降のバージョンで使用できます。

macOSにインストール

- 1 同梱のメディアに含まれるインストーラーファイルをダブルクリックします。ソフトウェアをBlackmagic Designウェブサイトからダウンロードした場合は、ダウンロードフォルダーでインストーラーファイルをダブルクリックします。
- 2 インストールの指示に従います。macOSがソフトウェアを自動でダウンロードします。

Windowsにインストール

- 1 同梱のメディアに含まれるインストーラーファイルをダブルクリックします。ソフトウェアをBlackmagic Designウェブサイトからダウンロードした場合は、ダウンロードフォルダーでインストーラーファイルをダブルクリックします。
- 2 インストール表示に従い、「License Agreement」で規約に同意します。Windowsがソフトウェアを自動でインストールします。

内部ソフトウェアのアップデート

- 1 Blackmagic Audio MonitorをUSBまたはイーサネットでコンピューターに接続します。
- 2 Blackmagic Audio Monitor Setupを開きます。
- 3 コンフィギュレーションアイコンをクリックします。アップデートが必要であるかどうかが表示されます。
- 4 アップデートが必要な場合は、「Update」ボタンをクリックしてソフトウェアのインストールを完了させます。



「Update」ボタンをクリックして内蔵ソフトウェアをアップデートします。

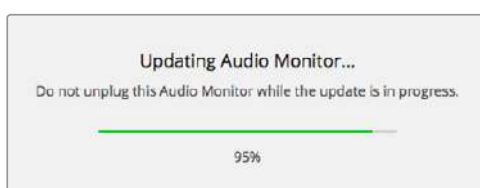

プログレスバーにアップデートの進行状況が表示されます。

- 5 アップデートが完了したら「Close」ボタンをクリックします。



Blackmagic Audio Monitor Setupユーティリティを使用して、Blackmagic Audio Monitorの内部ソフトウェアのアップデートおよびコンフィギュレーション設定の変更を実行。

Meterタブ

Setupユーティリティを開き、コンフィギュレーションアイコンをクリックして、オーディオレベル・メーター設定を表示します。メータータイプはVU、PPM、ラウドネスから、スケールタイプはEBU、BBCなどから選択できます。現在VUメーターが標準化されていますが、PPMおよびラウドネスメーターはスケールシステムや聴感上の音量測定に対応できます。次ページの表は、サポートされているオーディオレベルメーターとそれぞれの測定スケールです。

メータータイプ	スケールタイプ	測定スケール	使用方法
VU	-	-45 ~ +3	ユニットに記載
PPM	EBU	-12 ~ +12	ステッカーラベル
PPM	BBC	1 ~ 7	ステッカーラベル
ラウドネス	EBU +9	-18 ~ +9	ステッカーラベル
ラウドネス	EBU +18	-36 ~ +18	ステッカーラベル
ラウドネス	フルスケール +9	-41 ~ -14	ステッカーラベル
ラウドネス	フルスケール +18	-59 ~ -5	ステッカーラベル

VU

VUメーターは、オーディオ信号の短いピークおよびボトムを平均値を表示します。VUメーターは信号のピーク値のモニタリングに使用されることが多いですが、信号の平均値を表示できるため、オーディオの聴感上の音量をモニタリングする際にも使用できます。

PPM

PPMメーターは、「ピークホールド」機能に対応しています。この機能では、信号のピーク値の表示が保持されゆっくりと戻るため、オーディオのピーク値が簡単に確認できます。

ラウドネス

ラウドネスメーターは、オーディオ信号の主観的音量を表示します。今日の放送基準では、ラウドネス計測を行い、一定したオーディオラウドネスレベルを提供することが求められています。

VUおよびPPMメーターは、リファレンスレベルを-18dBまたは-20dBから選択できるため、様々な国際放送基準に合わせたオーディオモニタリングが可能です。

Blackmagic Audio MonitorのLEDリファレンスの挙動は、選択されたメータータイプによって異なります。Blackmagic Audio Monitorには、正確なリファレンススケールが表示されたステッカーラベルが同梱されており、これらを使用してオーディオのピーク値を簡単に確認できます。ラベルを使用するには、ラベルをはがし、カラーLEDメーターの間のVUスケールマークに重ねて貼り付けます。

オーディオレベル・メーターの各タイプおよび測定スケールごとに2枚ずつのラベルがあります。また、ステッカーラベルはBlackmagicサポートオフィスからでも入手可能です。Blackmagic Designサポートセンター (<https://www.blackmagicdesign.com/jp/support>) にアクセスし、お住まいの地域のサポートオフィスを確認してください。

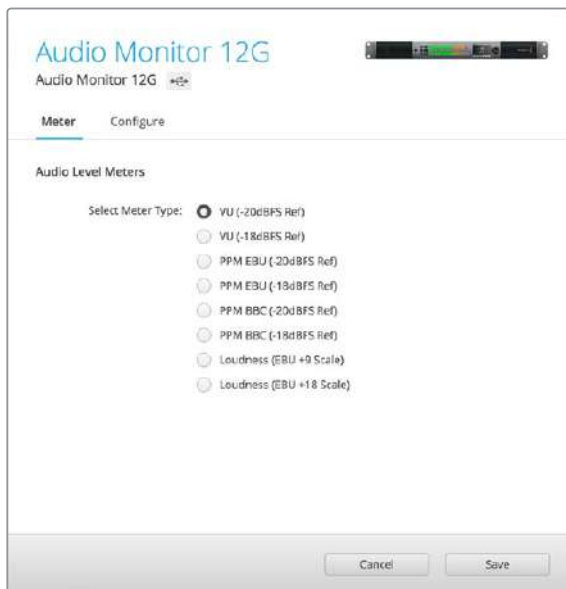

メーター設定を選択してBlackmagic Audio Monitorで表示するには、使用したいメータータイプを選択して「Save」をクリックします。

EBU PPM									
-12	-8	-4	0	+4	+8	+12			
-12	-8	-4	0	+4	+8	+12			
BBC PPM									
1	2	3	4	5	6	7			
1	2	3	4	5	6	7			
Loudness Units EBU +9dB									
-18	-15	-12	-9	-6	-3	0	+3	+6	+9
-18	-15	-12	-9	-6	-3	0	+3	+6	+9
Loudness Units Fullscale +9dB									
-41	-38	-35	-32	-29	-26	-23	-20	-17	-14
-41	-38	-35	-32	-29	-26	-23	-20	-17	-14
Loudness Units EBU +18dB									
-36	-30	-24	-18	-12	-6	0	+6	+12	+18
-36	-30	-24	-18	-12	-6	0	+6	+12	+18
Loudness Units Fullscale +18dB									
-59	-53	-47	-41	-35	-29	-23	-17	-11	-5
-59	-53	-47	-41	-35	-29	-23	-17	-11	-5

同梱のステッカーラベルを使用して、オーディオのピーク値を各メータータイプで正確に確認できます。

Configureタブ

Blackmagic Audio Monitor 12Gには「Configure」タブがあり、ソフトウェアのバージョンとBlackmagic Audio Monitorのネットワーク設定の情報が確認できます。また、ユニット名のラベルをカスタマイズすることも可能です。ユニット名をつけると、リモート接続の際に簡単に見つけることができます。

Blackmagic Audio Monitor 12Gにユニット名をつける

Blackmagic Audio Monitor 12Gにユニット名をつける：

- 1 「Configure」タブをクリックします。
- 2 「Details」設定の「Name」テキストボックスをクリックして新しい名前を入力します。
- 3 「Save」をクリックします。



ネットワーク設定の変更

ネットワークを介してBlackmagic Audio Monitor 12Gにアクセスすることは、複数のユニットを管理する最も簡単な方法です。これには、Blackmagic Audio Monitor Setupを使用します。デフォルトでは、Blackmagic Audio Monitor 12Gは自動的にネットワークアドレスを取得する設定になっているため、Setupユーティリティのホームスクリーンですぐに選択できます。

ネットワーク上のBlackmagic Audio Monitor 12Gが見つからない場合や、以前に設定した静的アドレスと現在のネットワークに互換性がない場合は、ネットワーク設定をマニュアルで変更する必要がある場合があります。これは、USBで実行できます。

USBでネットワーク設定を変更

USB経由でネットワーク設定を変更するには、Blackmagic Audio Monitor Setupを起動したコンピューターにBlackmagic Audio Monitor 12GをUSBケーブルで接続します。Blackmagic Audio Monitor 12GのUSBコネクタはリアパネルにあります。接続したら、Blackmagic Audio Monitor SetupのホームスクリーンからBlackmagic Audio Monitor 12Gを選択し、「Configure」に進みます。ここで、IP設定を「DHCP（動的）」と「Static IP（静的）」で切り替えられます。静的IPを選択すると「Configure」タブで、アドレス、サブネットマスク、ゲートウェイをマニュアルで変更可能になります。

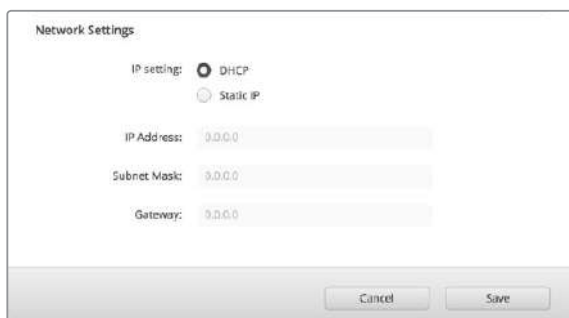

オプションのBlackmagic Dolby® デコーダーモジュールをインストール

DolbyはDolbyデコーダーモジュールの製造を中止していますが、すでにオリジナルのBlackmagic Audio Monitor用のモジュールを所有しており、インストールしたい場合は以下の手順に従ってください。

✖️ Blackmagic Audio Monitor 12GはDolbyデコーダーモジュールに対応していません。

警告

インストールの際にはBlackmagic Audio Monitor筐体のカバーを取り外してマザーボードにアクセスする必要があります。この作業は専門の技術者以外には行わないでください。静電気放電のリスクを低減するため、モジュールをインストールする際は十分に注意して作業を行ってください。

モジュールのインストール

Blackmagic Dolbyデコーダーモジュールをインストールすることで、最新の映画やテレビで使用されているDolby Digital/Dolby Eオーディオをモニタリングできます。Dolby 5.1サラウンドサウンドは、フロント左右チャンネル、リアサラウンド左右チャンネル、センターチャンネル、低周波数チャンネルにエンコードされています。

Dolbyデコーダーは72ピンSIMMモジュールで、Blackmagic Audio Monitorマザーボードの空きSIMMスロットに簡単にインストールできます。

Blackmagic Dolbyデコーダーモジュールをインストールする：

- 1 Blackmagic Audio Monitorに電源が接続されていないことを確認します。
- 2 プラスドライバーを使用して、Blackmagic Audio Monitorのカバーを固定している21個のネジを回して外します。カバーを取り外します。
- 3 Blackmagic Dolbyデコーダーモジュールを手に持ち、接続部分を空きSIMMスロットに向けます。モジュールのキー溝をSIMMスロットのキーと合わせます。これらを合わせないとモジュールを取り付けられません。
- 4 モジュールをSIMMスロットにゆっくりと差し込み、接続部分がしっかりと固定されたことを確認します。
- 5 金属製クリップがモジュールの両側を固定するまで、モジュールをBlackmagic Audio Monitorの後方に向かって傾けます。
- 6 Blackmagic Audio Monitorにカバーを被せ、21個のネジを締めて固定します。

Blackmagic Dolbyデコーダーモジュールをインストールしたら、Dolbyモジュールがインストールされていることを簡単に確認できるよう、同梱のDolbyステッカーをBlackmagic Audio Monitorバックパネルの警告ラベルの近くに貼り付けます。

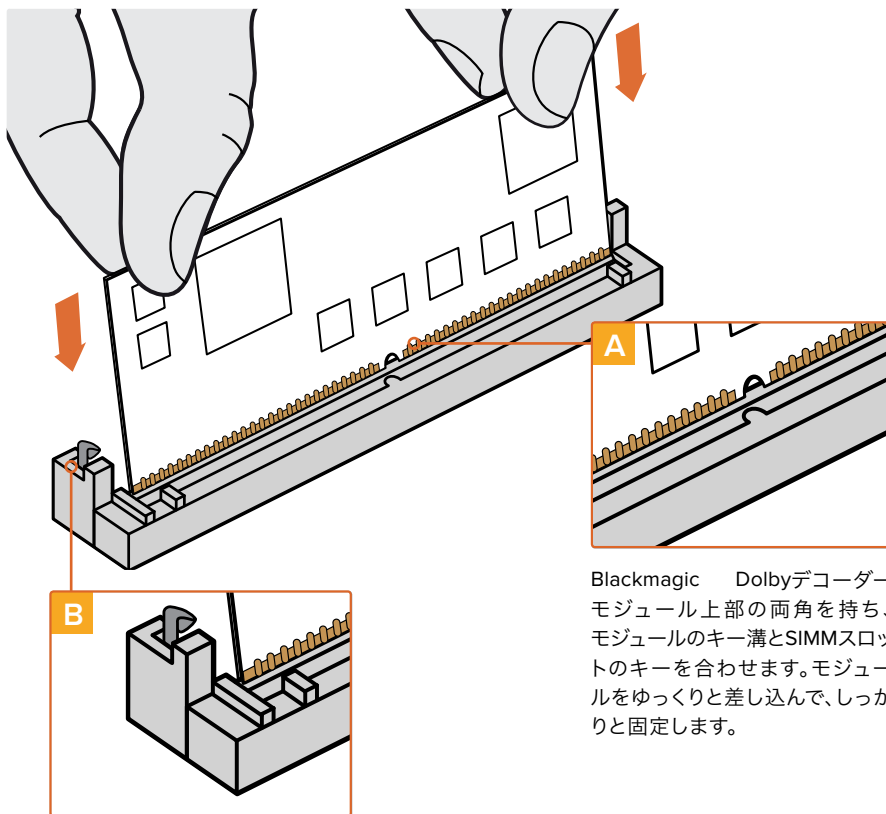

Blackmagic Dolbyデコーダーモジュール上部の両角を持ち、モジュールのキー溝とSIMMスロットのキーを合わせます。モジュールをゆっくりと差し込んで、しっかりと固定します。

Blackmagic Dolbyデコーダーモジュールを筐体の後方に向かって傾け、金属製のクリップで両側を固定します。

Dolbyオーディオの確認

DolbyエンコードオーディオがBlackmagic Audio Monitorによって検出されると、コントロールパネルLCDの右上にDolbyロゴが表示されます。コントロールパネルのチャンネルアップ/ダウンボタンを押して、4ペアのDolbyサラウンドチャンネルをモニタリングできます。

Developer Information

Controlling Blackmagic Audio Monitor 12G using Telnet

The Blackmagic Audio Monitor 12G Ethernet Protocol gives you the freedom to build your own custom control solutions for your Blackmagic Audio Monitor 12G. For example, you can create your own software application or web interface to control your Blackmagic Audio Monitor 12G via Ethernet from your computer.

The first step is to connect your Blackmagic Audio Monitor 12G to your computer via Ethernet. You can do this by connecting to the same network your computer is connected to, or you can connect Blackmagic Audio Monitor 12G directly to your computer.

NOTE If Blackmagic Audio Monitor 12G is connected directly to your computer, set your computer to a manual static IP address. Set the first three blocks of numbers in the IP address to match your Blackmagic Audio Monitor 12G and set the subnet mask to 255.255.255.0. You can leave the gateway or router setting blank as it will not be used in a direct connection between your computer and Blackmagic Audio Monitor 12G.

If your network settings are set correctly, you can now open the Terminal application on macOS, or enable Telnet command line utilities on Windows and enter Blackmagic Audio Monitor 12G Ethernet Protocol commands. These commands can be programmed into your application and triggered by related items on a custom user interface of your own design.

Using Telnet on macOS and Windows

- 1 On macOS, open the Terminal application which is located within the Applications > Utilities folder.

To open the command prompt in Windows, click on the 'start' menu and type 'cmd' in the search bar. Press 'enter'.

- 2 Type in "telnet" and a space followed by the IP address of your computer, then another space and "9996", which is the default port number for Blackmagic Audio Monitor 12G.

For example:

```
telnet 192.168.25.253 9996
```

Press 'enter'. The Protocol Preamble screen will appear.

Blackmagic Audio Monitor 12G Ethernet Protocol V1.0

Summary

The Blackmagic Audio Monitor 12G Ethernet Protocol is a text based protocol that is accessed by connecting to TCP port 9996 on a Blackmagic Audio Monitor 12G.

The Blackmagic Audio Monitor 12G sends information in blocks which each have an identifying header in all-caps, followed by a full-colon. A block spans multiple lines and is terminated by a blank line.

Each line in the protocol is terminated by a new line character.

Upon connection, the Blackmagic Audio Monitor 12G sends a complete dump of the state of the device. After the initial status dump, status updates are sent every time the Blackmagic Audio Monitor 12G status changes.

To be resilient to future protocol changes, clients should ignore blocks they do not recognize, up to the trailing blank line. Within existing blocks, clients should ignore lines they do not recognize.

Legend

↵ line feed or carriage return
... and so on

Version 1.0 of the Blackmagic Audio Monitor 12G Ethernet Protocol was released with Blackmagic Audio Monitor 12G 3.0 software.

Protocol Preamble

The first block sent by the Blackmagic Audio Monitor 12G is always the protocol preamble:

```
PROTOCOL PREAMBLE:  
Version: 1.0
```

The version field indicates the protocol version. When the protocol is changed in a compatible way, the minor version number will be updated. If incompatible changes are made, the major version number will be updated.

Device Information

The next block contains general information about the connected Blackmagic Audio Monitor 12G device. If a device is connected, the Blackmagic Audio Monitor 12G will report the attributes of the Blackmagic Audio Monitor 12G:

```
AUDIOMONITOR DEVICE:↵  
Model: Blackmagic Audio Monitor 12G  
Label: Blackmagic Audio Monitor 12G
```

Only the label can be modified.

```
AUDIOMONITOR DEVICE:↵  
Label: My new name↵  
↵
```

The response will be

```
ACK:  
AUDIOMONITOR DEVICE:  
Label: My new name
```

The next block will show the network settings which can only be changed via the Blackmagic Audio Monitor Setup utility when connected over USB. This is for information only.

```
NETWORK:  
Dynamic IP: 1  
Current address: 0.0.0.0  
Current subnet: 0.0.0.0  
Current gateway: 0.0.0.0
```

The next block is the meter type.

```
AUDIO METER:  
Meter Mode: VU (-20dBFS Ref)
```

This can be changed to VU (-20dBFS Ref), VU (-18dBFS Ref), PPM EBU (-20dBFS Ref), PPM EBU (-18dBFS Ref), PPM BBC (-20dBFS Ref), PPM BBC (-18dBFS Ref), Loudness (EBU +9 scale) or Loudness (EBU +18 scale)

```
AUDIO METER:↵  
Meter Mode: Loudness (EBU +18 scale)↵  
↵
```

The response will be

```
ACK:  
AUDIO METER:  
Meter Mode: Loudness (EBU +18 scale)
```

The next block is the input type.

```
AUDIO INPUT:  
Routing: Speaker Stereo SDI Stereo 1-2
```

This can be changed to SDI Stereo 3-4, SDI Stereo 5-6, SDI Stereo 7-8, SDI Stereo 9-10, SDI Stereo 11-12, SDI Stereo 13-14, SDI Stereo 15-16, XLR AES/EBU Stereo 1-2, XLR Analog Stereo or RCA Stereo

```
AUDIO INPUT:↵  
Routing: Speaker Stereo XLR AES/EBU Stereo 1-2↵  
↵
```

The response will be

```
ACK:  
AUDIO INPUT:  
Routing: Speaker Stereo XLR AES/EBU Stereo 1-2
```

The next block is the audio output state. This indicates the current headphone and speaker volume settings as well as the state of the mute and solo buttons.

```
AUDIO OUTPUT:  
Gain: Speaker Stereo 0  
Gain: Headphone Stereo 0  
Mute: false  
Solo: Off
```

The volume gain settings can be set between 0 and 255. Mute can be true or false and Solo can be Off, Left or Right

```
AUDIO OUTPUT:↵  
Gain: Speaker Stereo 125↵  
Solo: Right↵  
↵
```

The response will be

```
ACK:  
AUDIO OUTPUT:  
Gain: Speaker Stereo 125  
Solo: Right
```

Checking the Connection

While the connection to the Blackmagic Audio Monitor 12G is established, a client may send a special no-operation command to check that the Blackmagic Audio Monitor 12G is still responding:

```
PING:↵  
↵
```

If the Blackmagic Audio Monitor 12G is responding, it will respond with an ACK message as for any other recognized command.

Checking valid Protocol Commands

While the connection to the Blackmagic Audio Monitor 12G is established, a client may send a special HELP command to obtain a list of supported Telnet commands:

```
HELP:↵  
↵  
AUDIOMONITOR DEVICE:  
Model: <label> [read only]  
Label: <label>  
Unique ID: <label> [read only]  
  
NETWORK:  
Dynamic IP: <boolean> [read only]  
Current address: <IP_address> [read only]  
Current subnet: <IP_address> [read only]  
Current gateway: <IP_address> [read only]  
  
AUDIO METER:  
Meter Mode: <enum> -> <enum> = <"VU (-20dBFS Ref)" | "VU (-18dBFS Ref)" |  
"PPM EBU (-20dBFS Ref)" | "PPM EBU (-18dBFS Ref)" | "PPM BBC (-20dBFS Ref)"  
| "PPM BBC (-18dBFS Ref)" | "Loudness (EBU +9 scale)" | "Loudness (EBU +18  
scale)">;  
  
AUDIO INPUT:  
Routing: <enum1> <enum2> -> <enum1> = <"Speaker Stereo">; <enum2> = <"SDI  
Stereo 1-2" | "SDI Stereo 3-4" | "SDI Stereo 5-6" | "SDI Stereo 7-8" |  
"SDI Stereo 9-10" | "SDI Stereo 11-12" | "SDI Stereo 13-14" | "SDI Stereo  
15-16" | "XLR AES/EBU Stereo 1-2" | "XLR Analog Stereo" | "RCA Stereo">;  
  
AUDIO OUTPUT:  
Gain: <enum> <integer> -> <enum> = <"Speaker Stereo" | "Headphone  
Stereo">; <integer> = <0..255>;  
  
Mute: <boolean> -> <boolean> = <true | false>;  
  
Solo: <enum> -> <enum> = <"Off" | "Left" | "Right">;
```

ヘルプ

ヘルプライン

すぐに情報が欲しいかたは、Blackmagic Designオンラインサポートページで、Blackmagic Audio Monitorの最新サポート情報を確認できます。

Blackmagic Design オンラインサポートページ

最新のマニュアル、ソフトウェア、サポートノートは、www.blackmagicdesign.com/jp/supportのBlackmagicサポートセンターで確認できます。

Blackmagic Designフォーラム

弊社ウェブサイトのBlackmagic Designフォーラムは、様々な情報やクリエイティブなアイデアを共有できる有益なリソースです。経験豊富なユーザーやBlackmagic Designスタッフによって、すでに多くの問題の解決策が公開されていますので、このフォーラムを参考にすることで、現在の問題をすばやく解決できることがあります。ぜひご利用ください。Blackmagicフォーラムには、<http://forum.blackmagicdesign.com>からアクセスできます。

Blackmagic Designサポートに連絡する

サポートページやフォーラムで必要な情報を得られなかった場合は、サポートページの「メールを送信」ボタンを使用して、サポートのリクエストをメール送信してください。あるいは、サポートページの「お住まいの地域のサポートオフィス」をクリックして、お住まいの地域のBlackmagic Designサポートオフィスに電話でお問い合わせください。

現在インストールされているソフトウェアのバージョンを確認

コンピューターにインストールされているBlackmagic Audio Monitor Setupのバージョンを確認するには、「About Blackmagic Audio Monitor Setup」ウィンドウを開きます。

- macOSでは、アプリケーションフォルダーから「Blackmagic Audio Monitor Setup」を開きます。メニューで「About Blackmagic Audio Monitor Setup」を選択し、バージョン番号を確認します。
- Windows 10では、スタートページの「Blackmagic Audio Monitor Setup」タイルから「Blackmagic Audio Monitor Setup」を開きます。ヘルプメニューで「About Blackmagic Audio Monitor Setup」を選択し、バージョン番号を確認してください。

最新のソフトウェアアップデートを入手する

コンピューターにインストールされているBlackmagic Audio Monitor Setupのバージョンを確認したら、Blackmagicサポートセンター (www.blackmagicdesign.com/jp/support) で最新のソフトウェアアップデートをチェックしてください。常に最新のソフトウェアを使用することを推奨しますが、重要なプロジェクトの実行中は、ソフトウェアのアップデートは行わない方がよいでしょう。

規制に関する警告

欧州連合内での電気機器および電子機器の廃棄処分



製品に記載されている記号は、当該の機器を他の廃棄物と共に処分してはならないことを示しています。機器を廃棄するには、必ずリサイクルのために指定の回収場所に引き渡してください。機器の廃棄において個別回収とリサイクルが行われることで、天然資源の保護につながり、健康と環境を守る方法でリサイクルが確実に行われるようになります。廃棄する機器のリサイクルのための回収場所に関しては、お住まいの地方自治体のリサイクル部門、または製品を購入した販売業者にご連絡ください。



この機器は、FCC規定の第15部に準拠し、クラスAデジタル機器の制限に適合していることが確認されています。これらの制限は、商用環境で機器を使用している場合に有害な干渉に対する適切な保護を提供するためのものです。この機器は無線周波エネルギーを生成、使用、放出する可能性があります。また、指示に従ってインストールおよび使用しない場合、無線通信に有害な干渉を引き起こす恐れがあります。住宅地域で当製品を使用すると有害な干渉を引き起こす可能性があります。その場合はユーザーが自己責任で干渉に対処する必要があります。

動作は次の2つを条件とします：

- 1 本機は、有害な干渉を起こさない。
- 2 本機は希望しない動作を発生しかねない干渉を含む、いかなる受信干渉も受け入れる必要がある。

ISED Canadaステートメント

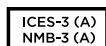

本機は、カナダのクラスAデジタル機器の規格に準拠しています。

本機のいかなる改造、あるいは目的の用途以外での使用は、これらの規格への順守を無効にすることがあります。

HDMIインターフェースへの接続は、必ず高品質のシールドHDMIケーブルを使用する必要があります。

本機は、商用環境で目的の用途に順守した使用においてテストを行なっています。非商業環境で使用された場合、無線妨害を引き起こす可能性があります。

安全情報

感電を避けるため、当製品は必ずアース端子付きコンセントに接続してください。不確かな場合は、資格を持つ電気技師に連絡してください。

感電のリスクを減らすため、水が跳ねたり、滴るような場所には置かないでください。

この製品は、周囲温度が最高40度までの熱帯地区での使用に対応しています。

通気が妨げられないように、この製品の周囲は通気に十分なスペースを開けるようにしてください。

ラックマウントする場合は、隣接する機器により通気が妨げられないようにしてください。

この製品の内部には、ユーザーが保守できる部品はありません。サービスに関しては、お近くのBlackmagic Designのサービスセンターにお問い合わせください。



海拔2000m以上では使用しないでください。

カリフォルニア州ステートメント

この製品のユーザーは、プラスチック部品内の微量の多臭素化ビフェニルなどの化学物質にさらされる可能性があります。カリフォルニア州は、多臭素化ビフェニルは発がん性があり、先天異常や生殖機能へ危害を及ぼす物質であると認識しています。

詳細は、以下のウェブサイトをご確認ください。 www.P65Warnings.ca.gov

保証

12ヶ月限定保証

Blackmagic Designは、お買い上げの日から12ヶ月間、本製品の部品および仕上がりについて瑕疵がないことを保証します。この保証期間内に製品に瑕疵が見つかった場合、Blackmagic Designは弊社の裁量において部品代および人件費無料で該当製品の修理、あるいは製品の交換のいずれかで対応いたします。

この保証に基づいたサービスを受ける際、お客様は必ず保証期限終了前にBlackmagic Designに瑕疵を通知し、適応する保証サービスの手続きを行ってください。お客様の責任において不良品を梱包し、Blackmagic Designが指定するサポートセンターへ配送料前払で送付いただきますようお願い致します。理由の如何を問わず、Blackmagic Designへの製品返送のための配送料、保険、関税、税金、その他すべての費用はお客様の自己負担となります。

不適切な使用、または不十分なメンテナンスや取扱いによる不具合、故障、損傷に対しては、この保証は適用されません。Blackmagic Designはこの保証で、以下に関してサービス提供義務を負わないものとします。a) 製品のインストールや修理、サービスを行うBlackmagic Design販売代理人以外の者によって生じた損傷の修理、b) 不適切な使用や互換性のない機器への接続によって生じた損傷の修理、c) Blackmagic Designの部品や供給品ではない物を使用して生じたすべての損傷や故障の修理、d) 改造や他製品との統合により時間増加や製品の機能低下が生じた場合のサービス。この保証は Blackmagic Designが保証するもので、明示または黙示を問わず他の保証すべてに代わるものです。Blackmagic Designとその販売社は、商品性と特定目的に対する適合性のあらゆる黙示保証を拒否します。Blackmagic Designの不良品の修理あるいは交換の責任が、特別に、間接的、偶発的、または結果的に生じる損害に対して、Blackmagic Designあるいは販売社がそのような損害の可能性についての事前通知を得ているか否かに関わらず、お客様に提供される完全唯一の救済手段となります。Blackmagic Designはお客様による機器のあらゆる不法使用に対して責任を負いません。Blackmagic Designは本製品の使用により生じるあらゆる損害に対して責任を負いません。使用者は自己の責任において本製品を使用するものとします。

© Copyright 2020 Blackmagic Design 著作権所有、無断複写・転載を禁じます。「Blackmagic Design」、「DeckLink」、「HDLink」、「Workgroup Videohub」、「Multibridge Pro」、「Multibridge Extreme」、「Intensity」、「Leading the creative video revolution」は、米国ならびにその他諸国での登録商標です。その他の企業名ならびに製品名全てはそれぞれ関連する会社の登録商標である可能性があります。



Manuel d'installation et d'utilisation

Blackmagic Audio Monitor 12G

Janvier 2020

Français



Bienvenue

Nous vous remercions d'avoir fait l'acquisition du Blackmagic Audio Monitor pour répondre à vos besoins de production.

Nous espérons que vous partagez le même rêve que nous, faire de l'industrie audiovisuelle un lieu créatif où chacun a accès à des équipements vidéo de grande qualité.

Le monitoring audio est essentiel à la production broadcast, à la postproduction ou à la production en direct. Le Blackmagic Audio Monitor offre toutes les fonctionnalités d'un outil de monitoring audio professionnel dans un format compact et montable sur rack. Vous pouvez désormais connecter tous les appareils audio de votre choix pour effectuer un monitoring de qualité. Le Blackmagic Audio Monitor original prend en charge le 6G-SDI pour connecter de la vidéo Ultra HD jusqu'à 30 images par seconde. Le Blackmagic Audio Monitor 12G prend en charge le 12G-SDI pour connecter de la vidéo Ultra HD jusqu'à 60 images par seconde. Il prend également en charge les signaux vidéo 3G-SDI de niveau A et B.

Ce manuel d'utilisation comprend toutes les informations dont vous avez besoin pour utiliser votre Blackmagic Audio Monitor.

Consultez notre page d'assistance sur www.blackmagicdesign.com/fr/support pour obtenir la dernière version de ce manuel et les mises à jour du logiciel Blackmagic Audio Monitor Setup. Nous vous recommandons de mettre le logiciel interne à jour régulièrement afin de travailler avec les fonctions les plus récentes. N'oubliez pas d'enregistrer vos coordonnées lorsque vous téléchargerez le logiciel afin d'être informé des dernières mises à jour. Nous souhaitons continuellement améliorer nos produits, n'hésitez donc pas à nous faire part de vos commentaires !

A cursive signature of Grant Petty in black ink, written in a fluid, handwritten style.

Grant Petty

PDG de Blackmagic Design

Sommaire

Blackmagic Audio Monitor 12G

Mise en route	49
Blackmagic Audio Monitor	49
Brancher l'audio	49
Sélection de la source audio	50
Connexion des sorties vidéo	50
Utilisation du Blackmagic Audio Monitor	51
Utilisation du panneau de contrôle	51
Écran LCD	51
Indicateurs de niveaux audio	51
Solo Left et Solo Right	52
Canal vers le haut et canal vers le bas	52
Input	53
Couper le son	53
Volume	53
Utilitaire Audio Monitor Setup	54
Utilitaire Blackmagic Audio Monitor Setup	54
Installation sous macOS	54
Installation sous Windows	54
Mise à jour du logiciel interne	54
Onglet Meter	55
Onglet Configure	57
Modifier les paramètres réseau	57
Installation du décodeur Blackmagic Dolby® en option	58
Installation du décodeur	58
Confirmation du décodeur Blackmagic Dolby	59
Developer Information	60
Controlling Blackmagic Audio Monitor 12G using Telnet	60
Blackmagic Audio Monitor 12G Ethernet Protocol V1.0	60
Assistance	64
Avertissements	65
Informations de sécurité	66
Garantie	67

Mise en route

Blackmagic Audio Monitor

Le Blackmagic Audio Monitor et le Blackmagic Audio Monitor 12G sont des solutions de monitoring audio en temps réel d'une unité de rack. Ils fonctionnent avec de nombreuses sources vidéo et audio pour les travaux de production broadcast en direct et de postproduction.

Le Blackmagic Audio Monitor se connecte à des équipements audio SD/HD/3G/6G-SDI, numériques AES/EBU et analogiques pour garantir des sorties ayant le niveau audio approprié. Le modèle 12G prend en charge le 12G-SDI pour connecter de la vidéo Ultra HD jusqu'à 60 images par seconde. Les indicateurs de niveaux à LED des canaux gauche et droit vous permettent de visualiser à quel niveau votre audio est écrêté. L'écran LCD intégré affiche le signal vidéo SDI ainsi que des informations importantes telles que le type d'entrée, le format vidéo, la fréquence d'images, les canaux audio et le niveau sonore.

Vous pouvez contrôler jusqu'à 16 canaux d'audio SDI intégré ou utiliser les connecteurs XLR pour l'audio analogique symétrique et l'audio numérique AES/EBU. Les connecteurs RCA permettent de le relier à des appareils grand public, tels que les systèmes HiFi et les iPod.

Le Blackmagic Audio Monitor intègre deux haut-parleurs à large bande internes de grande qualité et deux subwoofers qui permettent de reproduire parfaitement les fréquences graves. Vous pouvez également connecter un casque pour effectuer du monitoring dans des environnements bruyants.

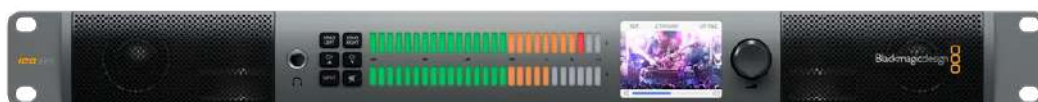

Face avant du Blackmagic Audio Monitor 12G



Face arrière du Blackmagic Audio Monitor 12G

Brancher l'audio

Le Blackmagic Audio Monitor prend en charge pratiquement tous les équipements audio. Si vous souhaitez connecter des signaux SDI en SD, HD, 2K ou Ultra HD, branchez l'entrée SDI avec un connecteur BNC standard. Le modèle 12G prend en charge les entrées vidéo 3G-SDI de niveau A et B.

Pour le monitoring de l'audio numérique AES/EBU sur des enregistreurs à disque et des consoles audio numériques ou analogiques, tels que les mixeurs audio et les lecteurs Betacam SP, utilisez les connecteurs XLR. Les connecteurs RCA standard permettent de relier l'audio analogique à des équipements grand public, tels que les magnétoscopes et les lecteurs DVD. Vous pouvez également brancher un casque grâce au jack TRS 1/4" pour un monitoring plus discret.

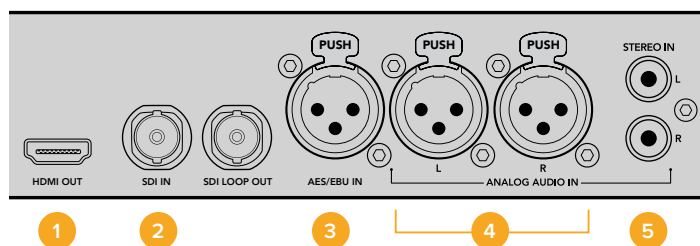

1. HDMI 2. Audio SDI intégré 3. XLR pour AES/EBU
4. XLR pour l'audio analogique 5. RCA pour les connexions audio grand public

Sélection de la source audio

Après avoir branché votre équipement audio au Blackmagic Audio Monitor, il vous suffit de sélectionner la connexion désirée en appuyant sur le bouton INPUT situé sur le panneau de contrôle. Lorsque votre entrée est sélectionnée et qu'un signal audio est présent, vous remarquerez que les LED des indicateurs de niveaux s'allument. Ils comportent deux rangées de LED de couleur qui s'allument pour confirmer que l'entrée audio fonctionne.

Le bouton INPUT vous permet de faire défiler les connexions audio et de les visualiser sur l'écran LCD avec d'autres informations, notamment le type d'entrée, les canaux audio et le niveau sonore. C'est tout ce que vous devez savoir pour contrôler l'audio avec le Blackmagic Audio Monitor.

Connexion des sorties vidéo

Si vous souhaitez contrôler la vidéo et l'audio, les sorties vidéo du Blackmagic Audio Monitor vous permettent de contrôler ces deux signaux sur un grand écran. Vous pouvez également simplement le connecter à d'autres appareils vidéo.

Les sorties HDMI et SDI en boucle peuvent être utilisées pour le monitoring de la vidéo et de l'audio intégré.

Vous pouvez le connecter à des appareils de capture SD, HD, 2K et Ultra HD, tels que le DeckLink 4K Extreme avec un seul câble SDI. Connectez la vidéo avec l'audio intégré à des enregistreurs, tels que des HyperDeck Studio via l'entrée SD/HD-SDI, ou à des écrans et projecteurs Ultra HD via l'entrée HDMI.

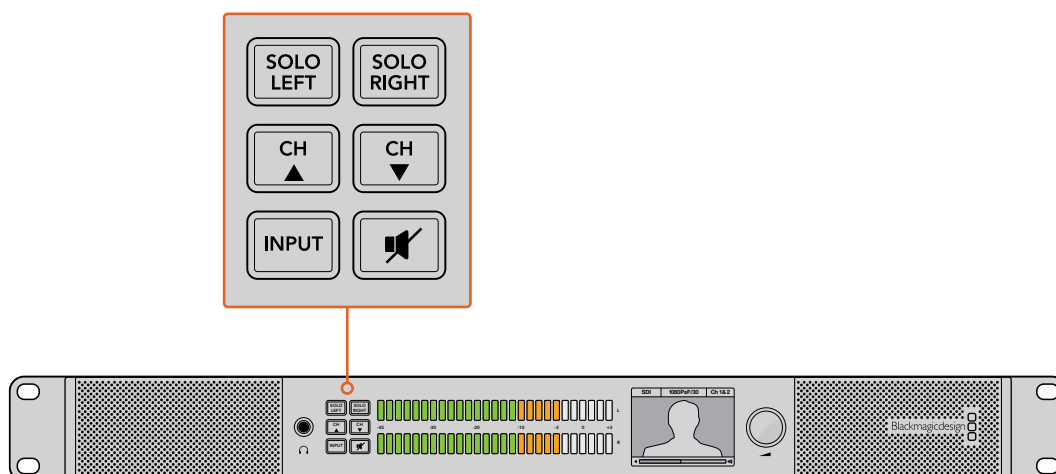

Les boutons de sélection permettent de choisir l'entrée que vous souhaitez contrôler, d'isoler les canaux gauche et droit, de faire défiler les canaux audio et de couper le son des haut-parleurs ou du casque.

Utilisation du Blackmagic Audio Monitor

Utilisation du panneau de contrôle

Le panneau de contrôle du Blackmagic Audio Monitor offre un accès rapide aux fonctionnalités essentielles et à l'état de l'appareil.

Écran LCD

L'écran en couleur intégré affiche les informations à l'écran, notamment, l'entrée sélectionnée, le format vidéo si un signal SDI est connecté, les canaux audio sélectionnés et le niveau sonore des haut-parleurs et du casque. De plus, il affiche les signaux vidéo SDI entrants. Si aucune vidéo SDI n'est détectée, une note de musique s'affiche à l'écran.

Les informations suivantes sont affichées pour chaque entrée :

Entrée SDI

SDI, le format vidéo et les canaux audio sélectionnés.

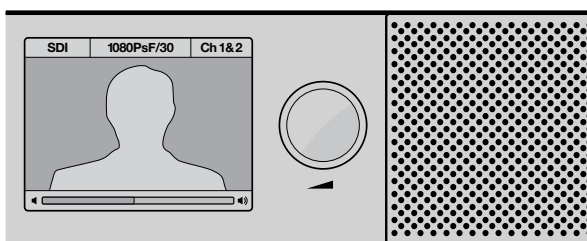

L'écran affiche les informations audio et vidéo, notamment le type de connexion, le format vidéo, les canaux audio sélectionnés et le niveau sonore.

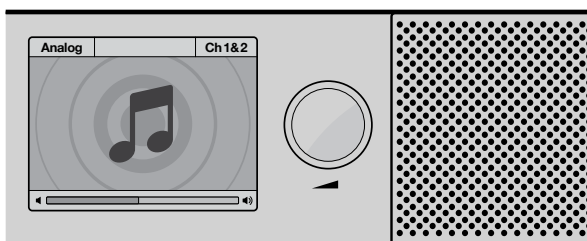

Une note de musique s'affiche sur l'écran, sauf si un signal vidéo SDI est détecté.

Entrée symétrique AES/EBU XLR

AES/EBU et les canaux audio sélectionnés.

Entrées analogiques symétriques XLR

Analogique et les canaux audio sélectionnés.

Entrées analogiques asymétriques RCA

HiFi et les canaux audio sélectionnés.

Indicateurs de niveaux audio

Les indicateurs de niveaux du Blackmagic Audio Monitor comportent deux bandes de LED vert, orange et rouge qui indiquent le niveau audio. Si tous les voyants sont allumés, les niveaux audio sont trop élevés et sont écrêtés.

Le comportement des vumètres change en fonction du type d'indicateur sélectionné dans les paramètres de l'utilitaire Audio Monitor Setup. Si vous utilisez le vumètre, réglez les niveaux de sortie de l'appareil audio de telle sorte que l'audio soit écrêté au delà de 0dB. Le curseur peut être réglé sur le panneau de contrôle. Cela maximise le rapport signal/bruit et vous permet d'obtenir un son de qualité optimale. Si votre audio dépasse le curseur placé à 0dB, il y a de fortes chances pour que votre son soit distordu.

Veuillez consulter la section « Utilitaire Audio Monitor Setup » de ce manuel pour obtenir des informations concernant l'installation du logiciel Blackmagic Audio Monitor Setup et la configuration des types d'indicateurs audio.

Solo Left et Solo Right

Ces boutons vous permettent d'isoler les canaux audio gauche et droit pour écouter indépendamment les canaux.

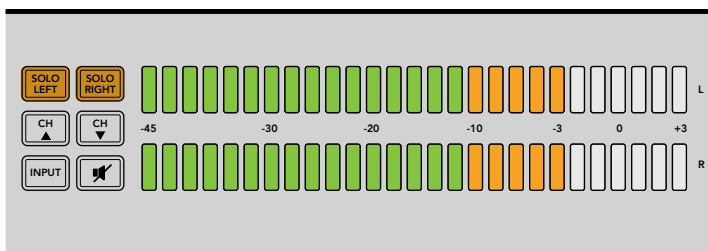

Le bouton SOLO LEFT permet de désactiver le canal audio droit. L'indicateur de niveau audio affiche tout de même les deux niveaux.

Pour écouter le canal audio gauche :

- 1 Appuyez sur le bouton Solo Left. Le bouton s'allume en vert, ce qui indique que l'audio n'est lu que sur le haut-parleur gauche.
- 2 Appuyez de nouveau sur Solo Left pour revenir au contrôle stéréo de l'audio.

Pour écouter le canal audio droit :

- 1 Appuyez sur le bouton Solo Right. Le bouton s'allume en vert, ce qui indique que l'audio n'est lu que sur le haut-parleur droit.
- 2 Appuyez de nouveau sur Solo Right pour revenir au contrôle stéréo de l'audio.

Canal vers le haut et canal vers le bas

Ces boutons permettent de faire défiler les canaux audio intégrés sur la connexion SDI. Pour le 3G-SDI, cela comprend jusqu'à 16 canaux, ou 8 paires de canaux. Appuyez sur le bouton flèche vers le haut ou vers le bas pour faire défiler les canaux audio SDI intégrés.

Le Blackmagic Audio Monitor 12G supporte le 12G-SDI, qui comprend jusqu'à 64 canaux audio, ou 32 paires de canaux. Maintenez les boutons flèche vers le haut ou vers le bas appuyés pour faire rapidement défiler les canaux.

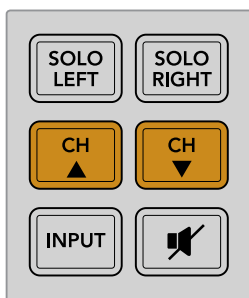

Input

Appuyez à plusieurs reprises sur le bouton INPUT pour faire défiler les entrées SDI, AES/EBU, analogique et HiFi et ainsi choisir l'équipement vidéo et audio que vous souhaitez contrôler.

Il est possible d'écouter l'entrée audio sélectionnée via les haut-parleurs intégrés et de faire du monitoring audio sur les canaux 1 et 2 de la sortie HDMI.

REMARQUE La sortie HDMI affiche un signal noir lorsque les entrées analogiques, AES/EBU ou HiFi sont sélectionnées. La sortie SDI en boucle achemine toujours la vidéo et l'audio connectés à l'entrée SDI.

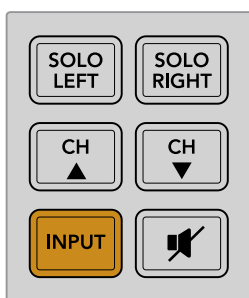

Couper le son

Ce bouton coupe le son des haut-parleurs et du casque. L'audio entrant ne sera pas affecté, seul le son provenant de la sortie haut-parleur et casque sera coupé. Appuyez de nouveau sur ce bouton pour réactiver l'audio sur la sortie haut-parleur et casque. Vous pouvez également restaurer l'audio en augmentant le volume.

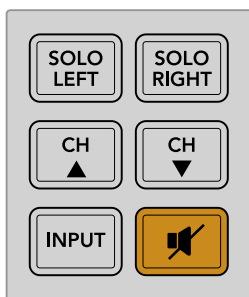

Volume

La molette permet de régler indépendamment le volume des haut-parleurs et du casque. Le niveau sonore est affiché sur l'écran LCD. Lorsqu'un casque est connecté, le son des haut-parleurs du Blackmagic Audio Monitor est coupé et l'audio est acheminé sur le casque. Le niveau sonore peut facilement être réglé en tournant la molette.

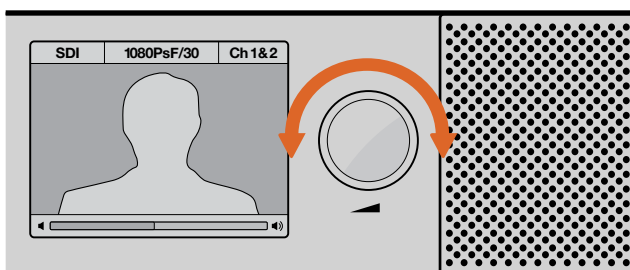

Le niveau sonore est affiché sur l'écran LCD.

Utilitaire Audio Monitor Setup

Utilitaire Blackmagic Audio Monitor Setup

Cet utilitaire vous permet de choisir le type d'indicateur de niveau audio désiré et de mettre à jour le logiciel interne de votre Blackmagic Audio Monitor.

Vous pouvez l'installer à l'aide de la carte SD fournie, cependant, nous vous recommandons de télécharger la dernière version du logiciel sur la page d'assistance de Blackmagic Design www.blackmagicdesign.com/fr/support.

Lorsque le Blackmagic Audio Monitor original est connecté à un ordinateur via USB, vous pouvez modifier les paramètres de configuration et mettre à jour le logiciel interne à l'aide de l'utilitaire. Sur le Blackmagic Audio Monitor 12G, vous pouvez également mettre à jour l'appareil et modifier les paramètres via Ethernet. Toutefois, pour changer les paramètres réseau, vous devrez être connecté via USB.

Le Blackmagic Audio Monitor Setup est compatible avec macOS Mojave 10.14 ou une version plus récente et avec Windows 10.

Installation sous macOS

- 1 Double-cliquez sur le programme d'installation à partir du support fourni ou à partir du dossier contenant vos téléchargements si vous avez téléchargé le logiciel sur le site Internet de Blackmagic Design.
- 2 Suivez les instructions relatives à l'installation, macOS installera alors le logiciel automatiquement.

Installation sous Windows

- 1 Double-cliquez sur le programme d'installation à partir du support fourni ou à partir du dossier contenant vos téléchargements si vous avez téléchargé le logiciel sur le site Internet de Blackmagic Design.
- 2 Suivez les instructions relatives à l'installation et acceptez les termes et conditions du contrat de licence pour que Windows installe automatiquement le logiciel.

Mise à jour du logiciel interne

- 1 Connectez votre Blackmagic Audio Monitor au port USB de votre ordinateur ou à Ethernet.
- 2 Ouvrez le Blackmagic Audio Monitor Setup.
- 3 Cliquez sur l'icône de configuration. L'utilitaire vous indiquera si une mise à jour est requise.
- 4 Si une mise à jour est requise, cliquez sur le bouton **Update** et attendez que l'installation du logiciel soit terminée.



Cliquez sur le bouton **Update** pour mettre à jour le logiciel interne.

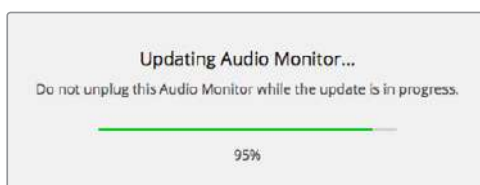

Une barre de progression affiche l'état de la mise à jour.

- 5 Cliquez sur le bouton **Close** lorsque la mise à jour est terminée.

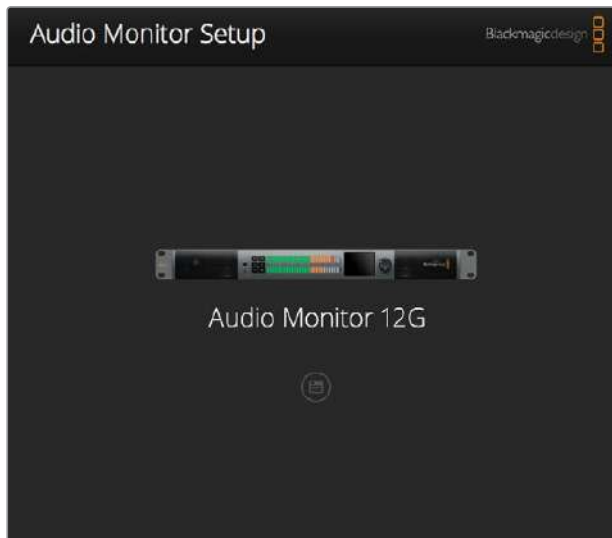

Mettez à jour le logiciel interne de votre Blackmagic Audio Monitor et modifiez les paramètres de configuration à l'aide de l'utilitaire Blackmagic Audio Monitor Setup.

Onglet Meter

Lorsque l'utilitaire est ouvert, cliquez sur l'icône de configuration pour afficher les paramètres relatifs aux indicateurs de niveaux audio. Vous pouvez choisir entre plusieurs types d'indicateurs tels que vumètre, PPM ou Loudness qui reposent sur les échelles EBU et BBC. Le vumètre est réglé pour un niveau standard, les indicateurs PPM et Loudness, quant à eux, prennent en compte le niveau sonore brut du programme. Le tableau suivant présente les indicateurs de niveaux audio et les échelles de mesure pris en charge.

Indicateurs de niveaux audio	Échelles	Échelles de mesure	Utilisation
VU	–	-45 à +3	Imprimé sur l'appareil
PPM	EBU	-12 à +12	Autocollant
PPM	BBC	1 à 7	Autocollant
Loudness	EBU +9	-18 à +9	Autocollant
Loudness	EBU +18	-36 à +18	Autocollant
Loudness	Full Scale +9	-41 à -14	Autocollant
Loudness	Full Scale +18	-59 à -5	Autocollant

VU

Cet indicateur affiche une moyenne des crêtes et des creux de votre signal audio. Le vumètre est en général utilisé pour contrôler les crêtes d'un signal, toutefois, comme il donne une valeur moyenne des niveaux, il peut également être utilisé pour contrôler l'impression de niveau ressentie par l'auditeur.

PPM

Ce crêtemètre comprend une fonction qui maintient momentanément les crêtes du signal et qui les fait redescendre lentement. Cela permet de visualiser aisément à quel niveau votre audio est écrêté.

Loudness

Cet indicateur affiche la qualité subjective du niveau sonore de votre signal audio. Les normes de diffusion actuelles incluent cet indicateur afin d'offrir des niveaux d'intensité sonore stables.

Le vumètre et le PPM intègrent un niveau de référence sélectionnable de -18dB ou de -20dB pour effectuer un monitoring audio en fonction des différentes normes de diffusion internationales.

Le comportement des LED du Blackmagic Audio Monitor change en fonction du type d'indicateur de niveau choisi. Des autocollants représentant avec précision les différentes échelles de dB sont fournis avec votre Blackmagic Audio Monitor pour vous permettre d'identifier aisément à quel niveau votre audio est écrêté. Il vous suffit de choisir et de coller l'autocollant de votre choix entre les indicateurs LED de couleur, afin de cacher l'échelle VU.

Deux autocollants sont inclus pour chaque indicateur de niveau audio et échelle de mesure. Vous pouvez également vous en procurer auprès du centre d'assistance technique Blackmagic Design de votre région. Veuillez vous rendre sur la page d'assistance de Blackmagic Design www.blackmagicdesign.com/fr/support pour trouver le centre d'assistance technique le plus proche de chez vous.

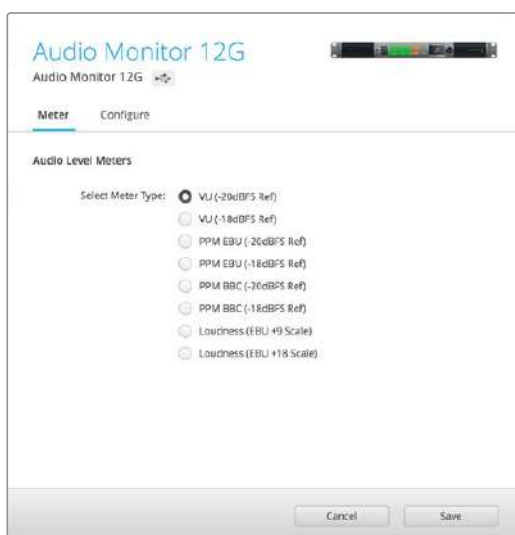

Pour choisir le type d'indicateur de niveau que vous souhaitez afficher sur votre Blackmagic Audio Monitor, cliquez sur l'indicateur de votre choix puis sur le bouton **Apply**.

EBU PPM									
-12	-8	-4	0	+4	+8	+12			
-12	-8	-4	0	+4	+8	+12			
BBC PPM									
1	2	3	4	5	6	7			
1	2	3	4	5	6	7			
Loudness Units EBU +9dB									
-18	-15	-12	-9	-6	-3	0	+3	+6	+9
-18	-15	-12	-9	-6	-3	0	+3	+6	+9
Loudness Units Fullscale +9dB									
-41	-38	-35	-32	-29	-26	-23	-20	-17	-14
-41	-38	-35	-32	-29	-26	-23	-20	-17	-14
Loudness Units EBU +18dB									
-36	-30	-24	-18	-12	-6	0	+6	+12	+18
-36	-30	-24	-18	-12	-6	0	+6	+12	+18
Loudness Units Fullscale +18dB									
-59	-53	-47	-41	-35	-29	-23	-17	-11	-5
-59	-53	-47	-41	-35	-29	-23	-17	-11	-5

Grâce aux autocollants, vous pouvez identifier avec précision à quel niveau votre audio est écrêté pour tous les types d'indicateurs de niveaux audio.

Onglet Configure

Sur le Blackmagic Audio Monitor 12G, vous trouverez l'onglet **Configure** qui liste le numéro de version du logiciel et qui contient les paramètres réseau du Blackmagic Audio Monitor. Il est aussi possible de personnaliser le nom de votre appareil. Nommer l'appareil vous aide à le localiser rapidement lorsqu'il est connecté à distance.

Nommer le Blackmagic Audio Monitor 12G

Pour nommer le Blackmagic Audio Monitor 12G :

- 1 Cliquez sur l'onglet **Configure**.
- 2 Sous le paramètre **Details**, cliquez sur la zone de texte **Name** et saisissez un nouveau nom.
- 3 Cliquez sur **Save**.



Modifier les paramètres réseau

Accéder au Blackmagic Audio Monitor 12G en réseau facilite la gestion de plusieurs appareils. Il est possible de configurer les appareils en réseau à l'aide du Blackmagic Audio Monitor Setup. Par défaut, le Blackmagic Audio Monitor 12G est réglé pour détecter automatiquement une adresse réseau, ce qui permet de choisir rapidement votre appareil depuis l'écran d'accueil du logiciel.

Si vous rencontrez des problèmes pour trouver un Blackmagic Audio Monitor 12G sur le réseau, ou si la configuration statique de l'adresse n'est pas compatible avec le réseau que vous utilisez, vous devrez peut-être modifier localement les réglages du réseau. Cette opération est réalisable via USB.

Modifier les paramètres réseau via USB

Pour configurer les paramètres réseau via USB, connectez votre Blackmagic Audio Monitor 12G à un ordinateur sur lequel est installé le logiciel Blackmagic Audio Monitor Setup, à l'aide d'un câble USB. Le port USB du Blackmagic Audio Monitor 12G se trouve sur la face arrière de l'appareil. Une fois connecté, sélectionnez votre Audio Monitor 12G depuis l'écran d'accueil du Blackmagic Audio Monitor Setup et naviguez jusqu'à l'onglet **Configure**. Vous pouvez alors choisir de configurer l'adresse réseau sur statique ou dynamique. Si vous choisissez l'option statique, vous pouvez configurer manuellement l'adresse, le masque de sous-réseau et la passerelle.

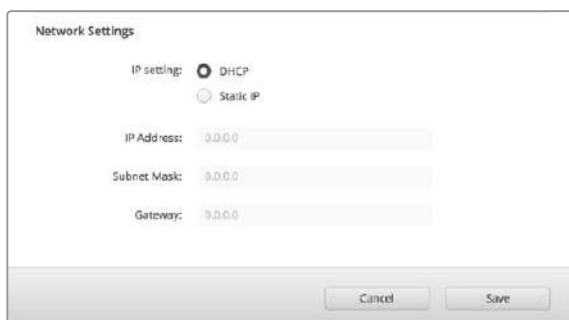

Installation du décodeur Blackmagic Dolby® en option

Le décodeur Dolby n'est plus disponible à la vente, cependant, si vous en possédez déjà un pour le modèle Blackmagic Audio Monitor original, veuillez suivre les instructions suivantes pour l'installer.

REMARQUE Le Blackmagic Audio Monitor 12G ne prend pas en charge le décodeur Dolby en option.

AVERTISSEMENT

Veillez à ce que l'alimentation soit débranchée du Blackmagic Audio Monitor avant d'installer le décodeur Dolby, car l'installation nécessite de retirer le couvercle du châssis afin d'accéder à la carte mère. Cette opération doit uniquement être réalisée par des techniciens qualifiés. Il est également important de prendre les précautions appropriées afin de réduire au maximum le risque de décharges électriques pendant l'installation du module.

Installation du décodeur

Le décodeur Blackmagic Dolby permet de contrôler l'audio Dolby Digital et Dolby E utilisés dans l'industrie audiovisuelle. Dolby 5.1 surround sound est encodé sur les canaux avants gauche et droit, les canaux arrières gauche et droit, le canal central et le canal pour les basses fréquences.

Le décodeur Blackmagic Dolby est un module SIMM à 72 broches qui peut facilement être installé sur les fentes SIMM vides de la carte mère de votre Blackmagic Audio Monitor.

Pour installer le décodeur Blackmagic Dolby :

- 1 Assurez-vous que le Blackmagic Audio Monitor est bien débranché.
- 2 Retirez les 21 vis du couvercle à l'aide d'un tournevis cruciforme. Retirez le couvercle.
- 3 Tenez le décodeur Blackmagic Dolby pour que les fiches se trouvent face à la fente SIMM vide. La rainure de la barette SIMM doit être alignée avec la rainure de la fente pour s'enclencher correctement.
- 4 Insérez doucement le module dans la fente SIMM jusqu'à ce que les fiches soient bien enclenchées.
- 5 Penchez-le vers l'arrière du Blackmagic Audio Monitor jusqu'à ce que les attaches métalliques s'enclenchent sur les côtés.
- 6 Remplacez le couvercle du Blackmagic Audio Monitor et revissez les 21 vis.

Après avoir installé le décodeur Blackmagic Dolby, collez l'autocollant sur le panneau arrière du Blackmagic Audio Monitor (à côté de l'autocollant d'avertissement) pour facilement voir qu'un module Dolby a été installé.

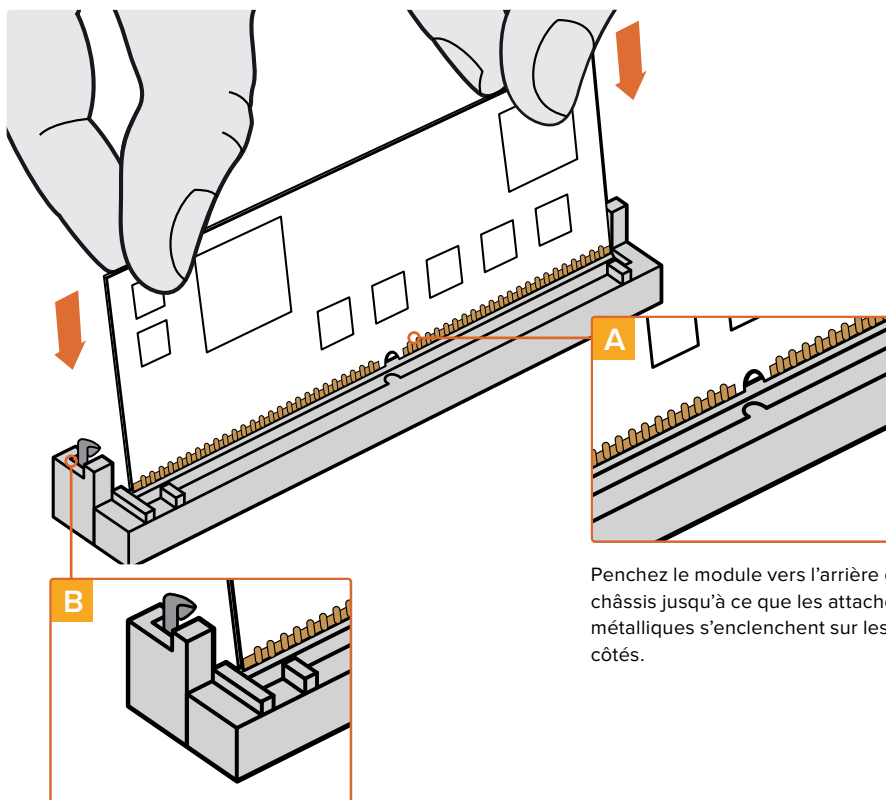

Penchez le module vers l'arrière du châssis jusqu'à ce que les attaches métalliques s'enclenchent sur les côtés.

Tenez le décodeur Blackmagic Dolby par les coins supérieurs, alignez la rainure du module avec les rainures de la fente SIMM et insérez-le doucement jusqu'à ce qu'il soit bien enclenché.

Confirmation du décodeur Blackmagic Dolby

Lorsque le décodeur Blackmagic Dolby est détecté par le Blackmagic Audio Monitor, le logo Dolby apparaît dans le coin supérieur droit de l'écran. Vous pouvez contrôler quatre paires de canaux surround en appuyant sur les boutons CH vers le haut et vers le bas du panneau de contrôle.

Developer Information

Controlling Blackmagic Audio Monitor 12G using Telnet

The Blackmagic Audio Monitor 12G Ethernet Protocol gives you the freedom to build your own custom control solutions for your Blackmagic Audio Monitor 12G. For example, you can create your own software application or web interface to control your Blackmagic Audio Monitor 12G via Ethernet from your computer.

The first step is to connect your Blackmagic Audio Monitor 12G to your computer via Ethernet. You can do this by connecting to the same network your computer is connected to, or you can connect Blackmagic Audio Monitor 12G directly to your computer.

NOTE If Blackmagic Audio Monitor 12G is connected directly to your computer, set your computer to a manual static IP address. Set the first three blocks of numbers in the IP address to match your Blackmagic Audio Monitor 12G and set the subnet mask to 255.255.255.0. You can leave the gateway or router setting blank as it will not be used in a direct connection between your computer and Blackmagic Audio Monitor 12G.

If your network settings are set correctly, you can now open the Terminal application on macOS, or enable Telnet command line utilities on Windows and enter Blackmagic Audio Monitor 12G Ethernet Protocol commands. These commands can be programmed into your application and triggered by related items on a custom user interface of your own design.

Using Telnet on macOS and Windows

- 1 On macOS, open the Terminal application which is located within the Applications > Utilities folder.

To open the command prompt in Windows, click on the 'start' menu and type 'cmd' in the search bar. Press 'enter'.

- 2 Type in "telnet" and a space followed by the IP address of your computer, then another space and "9996", which is the default port number for Blackmagic Audio Monitor 12G.

For example:

```
telnet 192.168.25.253 9996
```

Press 'enter'. The Protocol Preamble screen will appear.

Blackmagic Audio Monitor 12G Ethernet Protocol V1.0

Summary

The Blackmagic Audio Monitor 12G Ethernet Protocol is a text based protocol that is accessed by connecting to TCP port 9996 on a Blackmagic Audio Monitor 12G.

The Blackmagic Audio Monitor 12G sends information in blocks which each have an identifying header in all-caps, followed by a full-colon. A block spans multiple lines and is terminated by a blank line.

Each line in the protocol is terminated by a new line character.

Upon connection, the Blackmagic Audio Monitor 12G sends a complete dump of the state of the device. After the initial status dump, status updates are sent every time the Blackmagic Audio Monitor 12G status changes.

To be resilient to future protocol changes, clients should ignore blocks they do not recognize, up to the trailing blank line. Within existing blocks, clients should ignore lines they do not recognize.

Legend

↵ line feed or carriage return
... and so on

Version 1.0 of the Blackmagic Audio Monitor 12G Ethernet Protocol was released with Blackmagic Audio Monitor 12G 3.0 software.

Protocol Preamble

The first block sent by the Blackmagic Audio Monitor 12G is always the protocol preamble:

```
PROTOCOL PREAMBLE:  
Version: 1.0
```

The version field indicates the protocol version. When the protocol is changed in a compatible way, the minor version number will be updated. If incompatible changes are made, the major version number will be updated.

Device Information

The next block contains general information about the connected Blackmagic Audio Monitor 12G device. If a device is connected, the Blackmagic Audio Monitor 12G will report the attributes of the Blackmagic Audio Monitor 12G:

```
AUDIOMONITOR DEVICE:↵  
Model: Blackmagic Audio Monitor 12G  
Label: Blackmagic Audio Monitor 12G
```

Only the label can be modified.

```
AUDIOMONITOR DEVICE:↵  
Label: My new name↵  
↵
```

The response will be

```
ACK:  
AUDIOMONITOR DEVICE:  
Label: My new name
```

The next block will show the network settings which can only be changed via the Blackmagic Audio Monitor Setup utility when connected over USB. This is for information only.

```
NETWORK:  
Dynamic IP: 1  
Current address: 0.0.0.0  
Current subnet: 0.0.0.0  
Current gateway: 0.0.0.0
```

The next block is the meter type.

```
AUDIO METER:  
Meter Mode: VU (-20dBFS Ref)
```

This can be changed to VU (-20dBFS Ref), VU (-18dBFS Ref), PPM EBU (-20dBFS Ref), PPM EBU (-18dBFS Ref), PPM BBC (-20dBFS Ref), PPM BBC (-18dBFS Ref), Loudness (EBU +9 scale) or Loudness (EBU +18 scale)

```
AUDIO METER:↵  
Meter Mode: Loudness (EBU +18 scale)↵  
↵
```

The response will be

```
ACK:  
AUDIO METER:  
Meter Mode: Loudness (EBU +18 scale)
```

The next block is the input type.

```
AUDIO INPUT:  
Routing: Speaker Stereo SDI Stereo 1-2
```

This can be changed to SDI Stereo 3-4, SDI Stereo 5-6, SDI Stereo 7-8, SDI Stereo 9-10, SDI Stereo 11-12, SDI Stereo 13-14, SDI Stereo 15-16, XLR AES/EBU Stereo 1-2, XLR Analog Stereo or RCA Stereo

```
AUDIO INPUT:↵  
Routing: Speaker Stereo XLR AES/EBU Stereo 1-2↵  
↵
```

The response will be

```
ACK:  
AUDIO INPUT:  
Routing: Speaker Stereo XLR AES/EBU Stereo 1-2
```

The next block is the audio output state. This indicates the current headphone and speaker volume settings as well as the state of the mute and solo buttons.

```
AUDIO OUTPUT:  
Gain: Speaker Stereo 0  
Gain: Headphone Stereo 0  
Mute: false  
Solo: Off
```

The volume gain settings can be set between 0 and 255. Mute can be true or false and Solo can be Off, Left or Right

```
AUDIO OUTPUT:↵  
Gain: Speaker Stereo 125↵  
Solo: Right↵  
↵
```

The response will be

```
ACK:  
AUDIO OUTPUT:  
Gain: Speaker Stereo 125  
Solo: Right
```

Checking the Connection

While the connection to the Blackmagic Audio Monitor 12G is established, a client may send a special no-operation command to check that the Blackmagic Audio Monitor 12G is still responding:

```
PING:↵  
↵
```

If the Blackmagic Audio Monitor 12G is responding, it will respond with an ACK message as for any other recognized command.

Checking valid Protocol Commands

While the connection to the Blackmagic Audio Monitor 12G is established, a client may send a special HELP command to obtain a list of supported Telnet commands:

```
HELP:↵  
↵  
AUDIOMONITOR DEVICE:  
Model: <label> [read only]  
Label: <label>  
Unique ID: <label> [read only]  
  
NETWORK:  
Dynamic IP: <boolean> [read only]  
Current address: <IP_address> [read only]  
Current subnet: <IP_address> [read only]  
Current gateway: <IP_address> [read only]  
  
AUDIO METER:  
Meter Mode: <enum> -> <enum> = <"VU (-20dBFS Ref)" | "VU (-18dBFS Ref)" |  
"PPM EBU (-20dBFS Ref)" | "PPM EBU (-18dBFS Ref)" | "PPM BBC (-20dBFS Ref)"  
| "PPM BBC (-18dBFS Ref)" | "Loudness (EBU +9 scale)" | "Loudness (EBU  
+18 scale)">;  
  
AUDIO INPUT:  
Routing: <enum1> <enum2> -> <enum1> = <"Speaker Stereo">; <enum2> = <"SDI  
Stereo 1-2" | "SDI Stereo 3-4" | "SDI Stereo 5-6" | "SDI Stereo 7-8" | "SDI  
Stereo 9-10" | "SDI Stereo 11-12" | "SDI Stereo 13-14" | "SDI Stereo 15-16" |  
"XLR AES/EBU Stereo 1-2" | "XLR Analog Stereo" | "RCA Stereo">;  
  
AUDIO OUTPUT:  
Gain: <enum> <integer> -> <enum> = <"Speaker Stereo" | "Headphone Stereo">;  
<integer> = <0..255>;  
  
Mute: <boolean> -> <boolean> = <true | false>;  
  
Solo: <enum> -> <enum> = <"Off" | "Left" | "Right">;
```

Assistance

Obtenir de l'aide

Le moyen le plus rapide d'obtenir de l'aide est de consulter les pages d'assistance en ligne de Blackmagic Design et de consulter les informations les plus récentes concernant le Blackmagic Audio Monitor.

Pages d'assistance en ligne de Blackmagic Design

Les dernières versions du manuel, du logiciel et des notes d'assistance peuvent être consultées sur la page d'assistance technique de Blackmagic Design : www.blackmagicdesign.com/fr/support.

Forum Blackmagic Design

Le forum Blackmagic Design est une source d'information utile qui offre des idées innovantes pour vos productions. Cette plate-forme d'aide vous permettra également d'obtenir des réponses rapides à vos questions, car un grand nombre de sujets peuvent avoir déjà été abordés par d'autres utilisateurs. Pour vous rendre sur le forum : <http://forum.blackmagicdesign.com/>

Contactez le service d'assistance de Blackmagic Design

Si vous ne parvenez pas à trouver l'aide dont vous avez besoin dans les pages d'assistance ou sur notre forum, veuillez utiliser l'option « Envoyez-nous un email », accessible sur la page d'assistance pour envoyer une demande d'aide par email. Vous pouvez également cliquer sur le bouton « Trouver un support technique » situé sur la page d'assistance et contacter ainsi le centre d'assistance technique Blackmagic Design le plus proche de chez vous.

Vérification du logiciel actuel

Pour vérifier quelle version du logiciel Blackmagic Audio Monitor Setup est installée sur votre ordinateur, ouvrez la fenêtre About Blackmagic Audio Monitor Setup.

- Sur macOS, ouvrez Blackmagic Audio Monitor Setup dans le fichier Application. Sélectionnez À propos de Blackmagic Audio Monitor Setup dans le menu pour afficher la version du logiciel.
- Sur Windows 10, ouvrez le logiciel Blackmagic Audio Monitor Setup dans le menu de Démarrage. Cliquez sur le menu Aide et sélectionnez À propos de Blackmagic Audio Monitor Setup pour connaître le numéro de version.

Comment obtenir les dernières mises à jour du logiciel

Après avoir vérifié quelle version du logiciel Blackmagic Audio Monitor Setup est installée sur votre ordinateur, consultez sur la page d'assistance technique Blackmagic Design à l'adresse suivante www.blackmagicdesign.com/fr/support pour vérifier les dernières mises à jour. Même s'il est généralement conseillé d'installer les dernières mises à jour, il est prudent d'éviter d'effectuer ces mises à jour au milieu d'un projet important.

Avertissements

Élimination des déchets d'équipements électriques et électroniques au sein de l'Union européenne.



Le symbole imprimé sur ce produit indique qu'il ne doit pas être jeté avec les autres déchets. Cet appareil doit être déposé dans un point de collecte agréé pour être recyclé. La collecte individuelle et le recyclage de votre équipement permettra de préserver les ressources naturelles et garantit un recyclage approprié afin d'éviter la contamination de l'environnement par des substances dangereuses pour la santé. Pour obtenir plus d'informations sur les points de collecte pour recycler votre appareil, veuillez contacter l'organisme responsable du recyclage dans votre région ou le revendeur du produit.



Cet équipement a été testé et déclaré conforme aux limites imposées aux appareils numériques de classe A, en vertu du chapitre 15 des règles de la FCC. Ces limites ont pour objectif d'assurer une protection suffisante contre les interférences nuisibles lorsque l'équipement est utilisé dans un environnement commercial. Cet équipement génère, utilise et peut dégager de l'énergie de radiofréquence et, s'il n'est pas installé et utilisé conformément au manuel d'utilisation, peut provoquer un brouillage préjudiciable aux communications radio. L'utilisation de cet équipement en zone résidentielle est susceptible de provoquer des interférences nuisibles, auquel cas il sera demandé à l'utilisateur de corriger ces interférences à ses frais.

L'utilisation de cet appareil est soumise aux deux conditions suivantes :

- 1 Cet appareil ne doit pas causer d'interférences nuisibles.
- 2 Cet appareil doit accepter toute interférence reçue, y compris les interférences pouvant entraîner un dysfonctionnement.

Déclaration de ISDE Canada

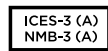

Cet appareil est conforme aux normes canadiennes relatives aux appareils numériques de Classe A.

Toute modification ou utilisation de ce produit en dehors de son utilisation prévue peut annuler la conformité avec ces normes.

Les connexions aux interfaces HDMI doivent être effectuées avec des câbles HDMI blindés d'excellente qualité.

Cet équipement a été testé pour être en conformité avec une utilisation prévue dans un environnement commercial. Si cet équipement est utilisé dans un environnement domestique, il peut provoquer des interférences radio.

Informations de sécurité

Pour une protection contre les décharges électriques, cet appareil doit être connecté à une prise secteur équipée d'un conducteur de protection. En cas de doute, veuillez contacter un électricien qualifié.

Afin de réduire le risque de décharge électrique, ne pas éclabousser ou renverser de liquide sur cet appareil.

Ce produit peut être utilisé dans un climat tropical lorsque la température ambiante n'excède pas 40°C.

Veillez à ce que l'espace autour du produit soit suffisant afin de ne pas compromettre la ventilation.

Lorsque vous installez l'appareil sur rack, veillez à ce que la ventilation ne soit pas compromise par les autres équipements.

Les pièces de cet appareil ne sont pas réparables par l'opérateur. Toute opération d'entretien doit être effectuée par un centre de service Blackmagic Design.



Cet appareil ne peut être utilisé qu'à une altitude inférieure à 2000 mètres.

Déclaration de l'État de Californie

Ce produit est susceptible de vous exposer à des produits chimiques, dont des traces de polybromobiphényle dans les parties en plastique, reconnu par l'État de Californie comme étant responsable de cancers, d'anomalies congénitales ou d'autres effets nocifs sur la reproduction.

Pour de plus amples informations, veuillez vous rendre sur www.P65Warnings.ca.gov.

Garantie

Garantie limitée à 12 mois

Par la présente, Blackmagic Design garantit que ce produit sera exempt de défauts matériels et de fabrication pendant une durée de un an à compter de la date d'achat. Si un produit s'avère défectueux pendant la période de garantie, Blackmagic Design peut, à sa seule discrétion, réparer le produit défectueux sans frais pour les pièces et la main-d'œuvre, ou le remplacer.

Pour se prévaloir du service offert en vertu de la présente garantie, il vous incombe d'informer Blackmagic Design de l'existence du défaut avant expiration de la période de garantie, et de prendre les mesures nécessaires pour l'exécution des dispositions de ce service. Le consommateur a la responsabilité de s'occuper de l'emballage et de l'expédition du produit défectueux au centre de service nommément désigné par Blackmagic Design, en frais de port prépayé. Il incombe au consommateur de payer tous les frais de transport, d'assurance, droits de douane et taxes et toutes autres charges relatives aux produits qui nous auront été retournés, et ce quelle que soit la raison.

La présente garantie ne saurait en aucun cas s'appliquer à des défauts, pannes ou dommages causés par une utilisation inappropriée ou un entretien inadéquat ou incorrect. Blackmagic Design n'a en aucun cas l'obligation de fournir un service en vertu de la présente garantie : a) pour réparer les dommages résultant de tentatives de réparations, d'installations ou tous services effectués par du personnel non qualifié par Blackmagic Design, b) pour réparer tout dommage résultant d'une utilisation inadéquate ou d'une connexion à du matériel incompatible, c) pour réparer tout dommage ou dysfonctionnement causés par l'utilisation de pièces ou de fournitures n'appartenant pas à la marque de Blackmagic Design, d) pour examiner un produit qui a été modifié ou intégré à d'autres produits quand l'impact d'une telle modification ou intégration augmente les délais ou la difficulté d'examiner ce produit. CETTE GARANTIE REMPLACE TOUTE GARANTIE EXPLICITE OU TACITE. BLACKMAGIC DESIGN ET SES REVENDEURS DÉCLINENT EXPRESSÉMENT TOUTE GARANTIE TACITE DE COMMERCIALISATION OU D'ADÉQUATION À UNE FIN PARTICULIÈRE. LA RESPONSABILITÉ DE BLACKMAGIC DESIGN POUR RÉPARER OU REMPLACER UN PRODUIT S'AVÉRANT DÉFECTUEUX CONSTITUE LA TOTALITÉ ET LE SEUL RECOURS EXCLUSIF PRÉVU ET FOURNI AU CONSOMMATEUR POUR TOUT DOMMAGE INDIRECT, SPÉCIFIQUE, ACCIDENTEL OU CONSÉCUTIF, PEU IMPORTE QUE BLACKMAGIC DESIGN OU SES REVENDEURS AIENT ÉTÉ INFORMÉS OU SE SOIENT RENDU COMPTE AU PRÉALABLE DE L'ÉVENTUALITÉ DE CES DOMMAGES. BLACKMAGIC DESIGN NE PEUT ÊTRE TENU POUR RESPONSABLE DE TOUTE UTILISATION ILLICITE DU MATÉRIEL PAR LE CONSOMMATEUR. BLACKMAGIC DESIGN N'EST PAS RESPONSABLE DES DOMMAGES RÉSULTANT DE L'UTILISATION DE CE PRODUIT. LE CONSOMMATEUR UTILISE CE PRODUIT À SES SEULS RISQUES.

© Copyright 2020 Blackmagic Design. Tous droits réservés. 'Blackmagic Design', 'DeckLink', 'HDLink', 'Workgroup Videohub', 'Multibrigde Pro', 'Multibrigde Extreme', 'Intensity' et 'Leading the creative video revolution' sont des marques déposées aux États-Unis et dans d'autres pays. Tous les autres noms de société et de produits peuvent être des marques déposées des sociétés respectives auxquelles ils sont associés.



Installations- und Bedienungsanleitung

Blackmagic Audio Monitor 12G

January 2020

Deutsch



Willkommen

Vielen Dank, dass Sie sich für Ihre Produktionsarbeit für einen Blackmagic Audio Monitor entschieden haben!

Wir verfolgen den Traum von der Entwicklung der Fernsehbranche zu einer echten Kreativbranche, indem wir jedem den Zugriff auf hochwertigste Videogeräte ermöglichen. In diesem Sinne wünschen wir Ihnen kreatives Schaffen.

Das Audiomonitoring spielt in jedem Videoproduktions-Workflow eine entscheidende Rolle, sei es im Rundfunk oder in der Post- oder Liveproduktion. Der Blackmagic Audio Monitor bietet Ihnen sämtliche Features von Profi-Audiomonitoren in einem kompakten rackmontierbaren Design. Für qualitativ anspruchsvolles Monitoring können Sie nahezu jedes Audiogerät an Ihren Blackmagic Audio Monitor anschließen. Der originale Blackmagic Audio Monitor unterstützt 6G-SDI für Ultra-HD-Video bis 30 Frames pro Sekunde, während der Blackmagic Audio Monitor 12G sogar 12G-SDI für Ultra-HD-Video bis 60 Frames pro Sekunde sowie eingehende 3G-SDI-Videosignale mit Level A und Level B unterstützt.

Diese Bedienungsanleitung gibt Ihnen alle Informationen, die Sie für die Inbetriebnahme Ihres Blackmagic Audio Monitors brauchen.

Auf der Support-Seite unserer Website unter www.blackmagicdesign.com/de finden Sie die aktuellste Auflage dieser Bedienungsanleitung sowie Updates für die Produktsoftware Ihres Blackmagic Audio Monitors. Wenn Sie Ihre Produktsoftware immer auf dem aktuellsten Stand halten, können Sie sichergehen, dass Sie stets Zugriff auf alle neuesten Features haben. Wenn Sie Software herunterladen, empfehlen wir Ihnen, sich zu registrieren, sodass wir Sie über neue Updates informieren können, sobald diese zur Verfügung stehen. Wir arbeiten ständig an neuen Features und Verbesserungen und würden uns freuen, von Ihnen zu hören!

A handwritten signature in black ink that reads "Grant Petty". The signature is written in a cursive, flowing style.

Grant Petty

CEO, Blackmagic Design

Inhaltsverzeichnis

Blackmagic Audio Monitor 12G

Erste Schritte	71
Der Blackmagic Audio Monitor	71
Anschließen von Audiogeräten	71
Auswählen Ihrer Audioquelle	72
Anschließen von Videoausgaben	72
Der Blackmagic Audio Monitor im Einsatz	73
Die Frontblende	73
LCD	73
Audiopegelmeter	73
SOLO LEFT und SOLO RIGHT	74
CH aufwärts und CH abwärts	74
Eingang	75
Stummschaltung	75
Lautstärke	75
Audio Monitor Setup	76
Blackmagic Audio Monitor Setup	76
Installation auf macOS-Systemen	76
Installation auf Windows-Systemen	76
Aktualisierung der Produktsoftware	76
Der „Meter“-Tab	77
Der „Configure“-Tab	79
Netzwerkeinstellungen ändern	79
Installation des optionalen Blackmagic Dolby® Decoder Moduls	80
Installation des Moduls	80
Bestätigung von Dolby Audio	81
Informationen für Entwickler (Englisch)	82
Controlling Blackmagic Audio Monitor 12G using Telnet	82
Blackmagic Audio Monitor 12G Ethernet Protocol V1.0	82
Hilfe	86
Gesetzliche Vorschriften	87
Sicherheitshinweise	88
Garantie	89

Erste Schritte

Der Blackmagic Audio Monitor

Der Blackmagic Audio Monitor und der Blackmagic Audio Monitor 12G beanspruchen nur eine Rack-Höheneinheit und bieten so eine Kompaktlösung für das Audio-Monitoring in Echtzeit, die mit vielen Video- und Audioquellen in der Live- und Postproduktion sowie im Rundfunk einsetzbar ist.

Der ursprüngliche Blackmagic Audio Monitor lässt sich an analoge und digitale SD-, HD-, 3G-, 6G-SDI- und AES/EBU-Audiogeräte anschließen, um die erforderlichen Ausgabetonpegel zu gewährleisten. Das 12G-Modell unterstützt 12G-SDI und eignet sich für Ultra-HD-Videoquellen bis 60 Frames pro Sekunde. LED-Pegelmeter für den linken und rechten Kanal zeigen die Scheitelwerte Ihres Tons an. Auf dem integrierten LCD sind Ihre SDI-Videoeingabe sowie wichtige Informationen wie Eingangsanschlusstyp, Videoformat, Framerate, Audiokanäle und Lautstärkepegel zu sehen.

So können Sie bis zu 16 Kanäle eingebettetes SDI-Audio überwachen oder die XLR-Buchsen für symmetrisches Analogaudio und AES/EBU-Digitalaudio benutzen. Über die ebenfalls vorhandenen RCA-Verbinder lassen sich Consumer-Geräte wie Hi-Fi-Anlagen und iPods anschließen.

Der Blackmagic Audio Monitor ist mit zwei hochwertigen integrierten Breitbandlautsprechern und zwei Subwoofern ausgestattet, die für ein breites Frequenzspektrum und damit für eine rundum klare und satte Schallwiedergabe sorgen. Oder schließen Sie einen Kopfhörer an, damit Sie auch in lauten Umgebungen Ihren Sound unter Kontrolle haben!



Die Vorderseite des Blackmagic Audio Monitor 12G



Die Vorderseite des Blackmagic Audio Monitor 12G

Anschließen von Audiogeräten

Blackmagic Audio Monitore unterstützen so gut wie jede Art von Audioequipment. SDI-Signalquellen in SD, HD, 2K oder sogar Ultra HD können Sie über den SDI-Eingang mithilfe von normalen BNC-Steckern anschließen. Das 12G-Modell unterstützt eingehende 3G-SDI-Videosignale mit Level-A- und Level-B-Mapping.

Für das Monitoring von digitalem AES/EBU-Audio können Sie Geräte wie Festplattenrekorder und digitale Tonmischpulte oder Analoggeräte wie Audiomixer oder Betacam SP Decks über XLR-Verbinder anschließen. Analogaudio von Consumer-Geräten wie Videorekordern und DVD-Playern lässt sich hingegen über standardmäßige RCA-Verbinder kontrollieren. Über die 6,35mm-Klinkenbuchse ist auch der Anschluss von Kopfhörern möglich. So hören nur Sie allein Ihr Audio, ohne andere zu stören.

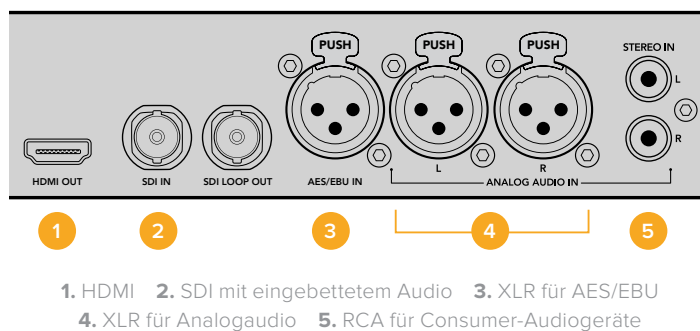

Auswählen Ihrer Audioquelle

Wenn Sie Ihr Audioequipment an den Blackmagic Audio Monitor angeschlossen haben, müssen Sie nur noch über die INPUT-Taste im Bedienfeld den gewünschten Eingang auswählen. Sobald Ihre Eingabe aktiviert ist und Audio erkannt wird, werden Sie sehen, dass die LEDs des Audiopegelmeters beginnen zu leuchten. Der Audiopegelmeter besteht aus zwei Reihen hell leuchtender farbiger LEDs. Über diese können Sie sich auf einen Blick vergewissern, dass die Audioeingabe funktioniert.

Durch Drücken der INPUT-Taste können Sie die einzelnen Audioverbindungen durchlaufen. Auf dem farbigen LCD werden Ihnen außerdem die dazugehörigen Daten wie Eingangstyp, Audiokanäle und Lautstärkepegel angezeigt. Mehr brauchen Sie nicht zu tun, um Audio mit Ihrem Blackmagic Audio Monitor zu überwachen!

Anschließen von Videoausgaben

Sollten Sie sowohl Video als auch Audio überprüfen müssen, können Sie sich beides über die Videoausgänge des Blackmagic Audio Monitors auf einem großen Bildschirm anzeigen lassen. Auch zusätzliche Videogeräte sind anschließbar.

Die HDMI- und SDI-Durchschleifausgänge lassen sich zur Überwachung von Video mit eingebettetem Audio einsetzen. Ein einziges SDI-Kabel ermöglicht den Anschluss an SD-, HD-, 2K- und sogar Ultra-HD-Aufzeichnungsgeräte wie z. B. die DeckLink 4K Extreme Capture-Karte. Schließen Sie die Videoquelle mit eingebettetem Audio über SD/HD-SDI an MAZen wie den HyperDeck Studio oder über HDMI an die neuesten Ultra-HD-Bildschirme und Projektoren an.

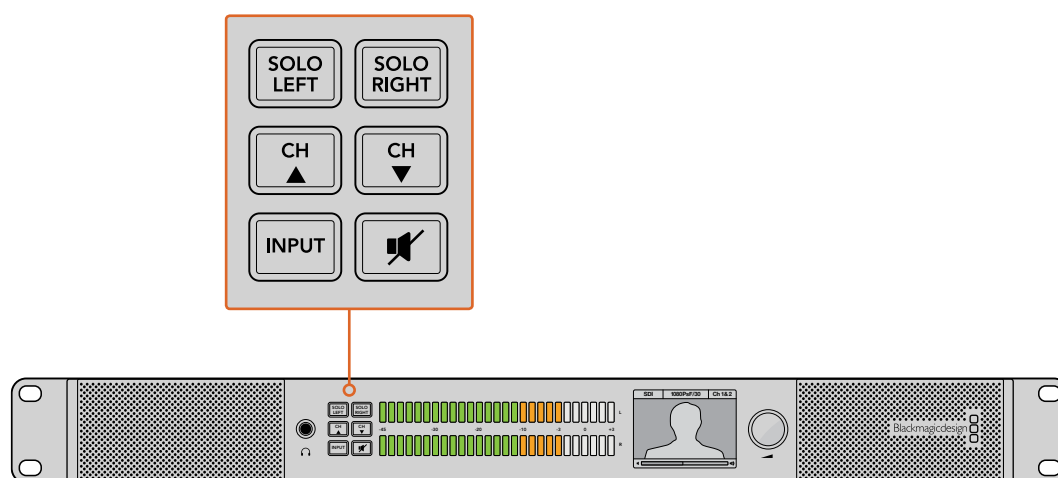

Mit den Auswahlstasten können Sie festlegen, welche Eingabe Sie überwachen möchten. Sie können die linken und rechten Stereokanäle isolieren, die verfügbaren Audiokanäle nach oben oder unten durchlaufen und Ihre Lautsprecher oder Kopfhörer stumm schalten

Der Blackmagic Audio Monitor im Einsatz

Die Frontblende

Über die Frontblende des Blackmagic Audio Monitors haben Sie schnellen Zugriff auf wichtige Funktionen und den Gerätestatus.

LCD

Das integrierte farbige LCD zeichnet sich durch ein Text-Overlay aus, das Ihnen entscheidende Statusinformationen anzeigt. Dazu zählen Ihr ausgewählter Eingang, das Videoformat (sofern Video über SDI angeschlossen ist), selektierte Audiokanäle und der Lautstärkepegel Ihrer Lautsprecher oder Kopfhörer. Das LCD zeigt zudem alle eingehenden SDI-Videosignale an. Wird kein SDI-Video erkannt, erscheint ein Notensymbol.

Folgende Informationen werden für jeden ausgewählten Eingang angezeigt:

SDI-Eingang

SDI, Videoformat, ausgewählte Audiokanäle.

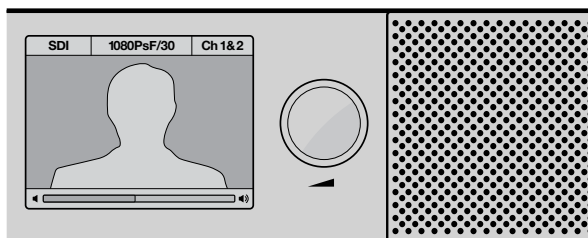

Das farbige LCD zeigt Audio- und Videoinformationen an, einschließlich Anschlusstyp, Videoformat, aktivierte Audiokanäle und Lautstärkepegel

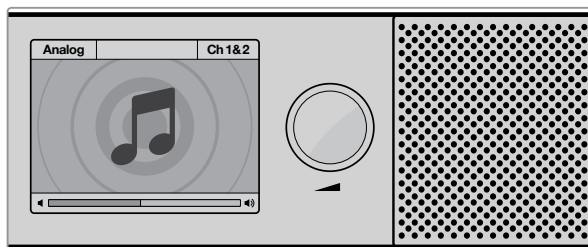

Wenn kein SDI-Videosignal zum Monitoring ausgewählt ist, zeigt das LCD ein Notensymbol an

Symmetrischer AES/EBU XLR-Eingang

AES/EBU, ausgewählte Audiokanäle.

Symmetrische XLR-Analogueingänge

Analog, ausgewählte Audiokanäle.

Unsymmetrische RCA-Analogueingänge

Hi-Fi, ausgewählte Audiokanäle.

Audiopegelmeter

Die Audiopegelmeter des Blackmagic Audio Monitors bestehen aus zwei Reihen grüner, orangefarbener und roter LEDs, die die Stärke der Audiopegel anzeigen. Wenn alle LEDs aufleuchten, sind Ihre Tonpegel zu hoch und werden abgeschnitten.

Das Verhalten der Audiopegelmeter ist abhängig von der Einstellung des Messmodus, die Sie im Blackmagic Audio Monitor Setup Dienstprogramm vorgegeben haben. Sollten Sie sich für die VU-Messung entschieden haben, passen Sie die Ausgabepegel Ihres Audioequipments so an, dass das Meter an der Frontblende bei 0 dB gipfelt. Dies optimiert den Störspannungsabstand und gewährleistet die höchste Tonqualität. Schlagen die Tonpegel über 0 dB aus, besteht ein hohes Risiko der Soundverzerrung.

Näheres zur Installation des Blackmagic Audio Monitor Setup Dienstprogramms und zur Einstellung der Pegelmessmodi finden Sie im Kapitel „Blackmagic Audio Monitor Setup“.

SOLO LEFT und SOLO RIGHT

Mit diesen Tasten können Sie jeweils den linken und rechten Audiokanal isolieren, damit Sie jeden Kanal separat auf potenzielle Tonprobleme überprüfen können.

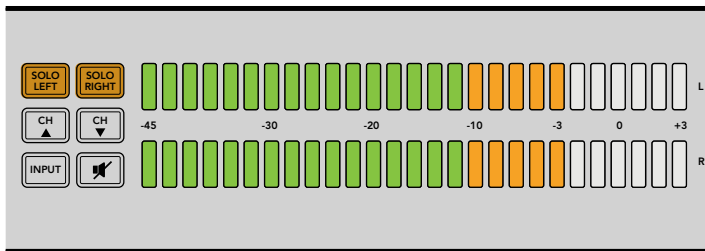

Die Auswahl von SOLO LEFT deaktiviert den rechten Audiokanal. Der Audiopegelmeter zeigt jedoch weiterhin beide Pegel an.

So kontrollieren Sie das Audio des linken Kanals:

- 1 Drücken Sie die Taste SOLO LEFT. Die Taste leuchtet grün auf und Ihr Audio wird nur über den linken Lautsprecher wiedergegeben.
- 2 Drücken Sie die Taste SOLO LEFT erneut, um auf Audiomonitoring in Stereo zurückzuschalten.

So kontrollieren Sie das Audio des rechten Kanals:

- 1 Drücken Sie die Taste SOLO RIGHT. Die Taste leuchtet grün auf und Ihr Audio wird nur über den rechten Lautsprecher wiedergegeben.
- 2 Drücken Sie die Taste SOLO RIGHT erneut, um auf Audiomonitoring in Stereo zurückzuschalten.

CH aufwärts und CH abwärts

Mit den CH-Tasten können Sie in Ihre SDI-Eingabe eingebettete Audiokanäle durchlaufen. Für 3G-SDI stehen bis zu 16 Kanäle bzw. 8 Paare zur Verfügung. Drücken Sie die Tasten für CH aufwärts bzw. CH abwärts, um sich durch die eingebetteten SDI-Audiokanäle zu bewegen.

Der Blackmagic Audio Monitor 12G unterstützt 12G-SDI und damit bis zu 64 Kanäle Audio bzw. 32 Kanalpaare. Um durch die Kanäle zu scrollen, drücken Sie die Auf- oder Abwärts-Pfeiltasten.

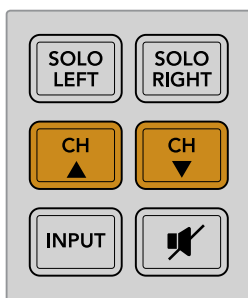

Eingang

Durch mehrfaches Drücken der INPUT-Taste durchlaufen Sie die SDI-, AES/EBU-, Analog- und Hi-Fi-Eingänge. So können Sie auswählen, welche Video- und Audiogeräte Sie kontrollieren wollen.

Die ausgewählte Audioeingabe kann man sich über die eingebauten Lautsprecher anhören. Zudem können Sie Ihren Ton auf Kanal 1 und 2 der HDMI-Ausgabe überwachen.

HINWEIS Ist ein Analog-, AES/EBU- oder HiFi-Eingang ausgewählt, zeigt die HDMI-Ausgabe schwarzes Video an. Über den SDI-Ausgang mit Durchschleifung wird immer das SDI-Video- und Audioingangssignal ausgegeben.

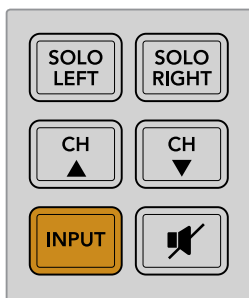

Stummschaltung

Mit der Stummschalttaste lassen sich die Lautsprecher und Kopfhörer des Blackmagic Audio Monitors stumm schalten. Die Stummschaltung des Tons hat keine Auswirkung auf Ihre Audioeingabe, sondern lediglich auf die Lautsprecher- und Kopfhörerausgabe. Durch erneutes Drücken der Stummschalttaste wird das Audio der Lautsprecher und Kopfhörer wiederhergestellt. Auch das Hochfahren der Lautstärke stellt den Ton wieder her.

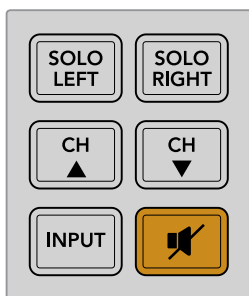

Lautstärke

Dieser Regler passt die Lautstärke der Lautsprecher und Kopfhörer unabhängig voneinander an. Der Lautstärkepegel wird auf dem integrierten LCD angezeigt. Werden Kopfhörer angeschlossen, schalten die Lautsprecher des Blackmagic Audio Monitors auf stumm und die Audioausgabe erfolgt über die Kopfhörer. Der Lautstärkepegel lässt sich durch Drehen des Lautstärkereglers im oder gegen den Uhrzeigersinn mühelos lauter oder leiser stellen.

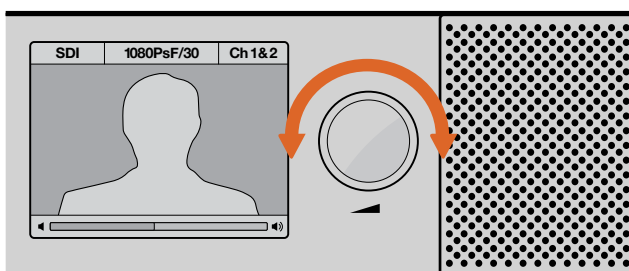

Der Lautstärkepegel wird auf dem Frontblenden-LCD angezeigt

Audio Monitor Setup

Blackmagic Audio Monitor Setup

Über das Dienstprogramm des Blackmagic Audio Monitors können Sie den gewünschten Messmodus vorgeben und die Produktsoftware Ihres Blackmagic Audio Monitors aktualisieren.

Das Dienstprogramm kann unter Einsatz der mitgelieferten SD-Karte installiert werden. Wir empfehlen jedoch, die neueste Version aus dem Blackmagic Design Support Center unter www.blackmagicdesign.com/support/de herunterzuladen.

Um beim originalen Blackmagic Audio Monitor die Konfigurationseinstellungen anzupassen und die Produktsoftware zu aktualisieren, muss der Monitor per USB an einen Computer angeschlossen sein. Den Blackmagic Audio Monitor 12G können Sie außerdem per Ethernet aktualisieren. Einstellungen können Sie auf die gleiche Weise anpassen. Für Anpassungen der Netzwerkeinstellungen muss das Gerät jedoch über USB verbunden sein.

Blackmagic Audio Monitor Setup läuft auf macOS Mojave 10.14 oder höher sowie auf Windows 10.

Installation auf macOS-Systemen

- 1 Doppelklicken Sie in den mitgelieferten Medien oder – wenn Sie die Software von der Blackmagic Design Website heruntergeladen haben – in Ihrem Downloads-Ordner auf die Installationsdatei.
- 2 Folgen Sie den Anweisungen, woraufhin macOS die Software automatisch installiert.

Installation auf Windows-Systemen

- 1 Doppelklicken Sie auf die Installationsdatei in den mitgelieferten Medien oder – wenn Sie die Software von der Blackmagic Design Website heruntergeladen haben – in Ihrem Downloads-Ordner.
- 2 Folgen Sie den Anweisungen und akzeptieren Sie die Bedingungen der Lizenzvereinbarung. Windows installiert die Software daraufhin automatisch.

Aktualisierung der Produktsoftware

- 1 Schließen Sie Ihren Blackmagic Audio Monitor per USB oder Ethernet an Ihren Computer an.
- 2 Öffnen Sie Blackmagic Audio Monitor Setup.
- 3 Klicken Sie auf das Konfigurationssymbol. Das Dienstprogramm zeigt Ihnen an, falls ein Update erforderlich ist.
- 4 Ist ein Update erforderlich, klicken Sie auf den „Update“-Button, um die Installation der Software abzuschließen.



Klicken Sie auf den „Update“-Button um die Aktualisierung der Produktsoftware zu starten



Ein Fortschrittsbalken zeigt Ihnen den Status der Aktualisierung an

- 5 Klicken Sie nach erfolgter Aktualisierung auf „Close“ (Schließen).

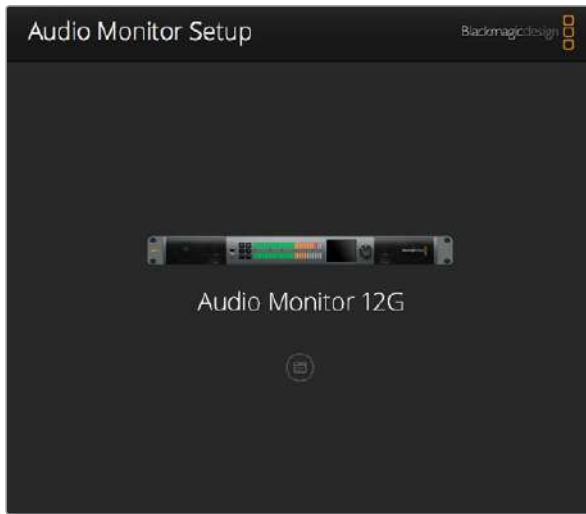

Aktualisieren Sie die Produktsoftware Ihres Blackmagic Audio Monitors und passen Sie die Konfigurationseinstellungen mithilfe des Blackmagic Audio Monitor Dienstprogramms an

Der „Meter“-Tab

Öffnen Sie das Dienstprogramm für das Setup und klicken Sie auf das Konfigurationssymbol, um die Einstellungen für den Audiopegelmeter anzuzeigen. Es stehen die Messmodi VU, PPM und Lautheit mit EBU- und BBC-Messskalen zur Auswahl. VU-Meter sind mittlerweile zum Standard geworden. Peakmeter (PPM) und Lautheitsmeter hingegen liefern Skalierungssysteme und -messungen für wahrgenommene Lautheit. Ihr Blackmagic Audio Monitor unterstützt folgende Audiopegelmeter und Messgrößen-Kombinationen:

Messmodus	Skalatyp	Messskala	Anwendung
VU	–	-45 bis +3	Aufdruck am Gerät
PPM	EBU	-12 bis +12	Aufkleber
PPM	BBC	1 bis 7	Aufkleber
Lautheit	EBU +9	-18 bis +9	Aufkleber
Lautheit	EBU +18	-36 bis +18	Aufkleber
Lautheit	Vollpegel +9	-41 bis -14	Aufkleber
Lautheit	Vollpegel +18	-59 bis -5	Aufkleber

VU

Dieses Meter erstellt einen Durchschnittswert aus kurzen Spitzen- und Tiefstwerten in Ihrem Audiosignal. Er dient vor allem zum Monitoring von Spitzenwerten eines Signals, eignet sich aufgrund seiner Fähigkeit zur Mittelwertbildung jedoch auch zur Kontrolle wahrgenommener Lautheit Ihres Audiosignals.

PPM

Das Peakmeter verfügt über eine „Peak-Hold“-Funktion, die Signalhöchstwerte anzeigt, vorübergehend festhält und langsam zurückgehen lässt, wodurch Audio-Peaking leicht visuell erkennbar wird.

Lautheit

Das Lautheitsmeter zeigt die subjektiv wahrgenommene Lautstärke Ihres Audiosignals an. Heutzutage gehört die Lautheitsmessung für durchgängige Lautheitspegel zu den Rundfunkstandards.

Beim VU- und Peakmeter können Sie einen Referenzpegel von -18 dB oder -20 dB wählen, was Ihnen die Tonkontrolle nach unterschiedlichen internationalen Rundfunkstandards gestattet.

Das Verhalten der Referenz-LEDs Ihres Blackmagic Audio Monitors ändert sich dann entsprechend dem ausgewählten Messmodus. Im Lieferumfang Ihres Blackmagic Audio Monitors sind Aufkleber mit präzisen dB-Referenzskalen enthalten. Anhand dieser können Sie sehen, welchen Spitzenwert Ihr Ton erreicht. Entfernen Sie die Folie vom Aufkleber mit der gewünschten Skala und kleben Sie ihn zwischen die farbigen LED-Anzeigen über die vorhandene VU-Skalamarkierung.

Für jeden Audiomessmodus und jede Messskala werden jeweils zwei Aufkleber mitgeliefert. Bögen mit weiteren Aufklebern sind zudem bei Ihrer lokalen Blackmagic Design Support-Stelle erhältlich. Besuchen Sie Ihr Blackmagic Design Support Center unter www.blackmagicdesign.com/de/support, um Ihr lokales Support-Team zu finden.



Um eine Messeinstellung für Ihren Blackmagic Audio Monitor zu wählen, klicken Sie zunächst auf den gewünschten Messmodus und anschließend auf „Save“ (Speichern)

EBU PPM									
-12	-8	-4	0	+4	+8	+12			
-12	-8	-4	0	+4	+8	+12			
BBC PPM									
1	2	3	4	5	6	7			
1	2	3	4	5	6	7			
Loudness Units EBU +9dB									
-18	-15	-12	-9	-6	-3	0	+3	+6	+9
-18	-15	-12	-9	-6	-3	0	+3	+6	+9
Loudness Units Fullscale +9dB									
-41	-38	-35	-32	-29	-26	-23	-20	-17	-14
-41	-38	-35	-32	-29	-26	-23	-20	-17	-14
Loudness Units EBU +18dB									
-36	-30	-24	-18	-12	-6	0	+6	+12	+18
-36	-30	-24	-18	-12	-6	0	+6	+12	+18
Loudness Units Fullscale +18dB									
-59	-53	-47	-41	-35	-29	-23	-17	-11	-5
-59	-53	-47	-41	-35	-29	-23	-17	-11	-5

Die mitgelieferten Aufkleber helfen Ihnen dabei, das Peaking Ihres Tons bei jedem Messmodus akkurat zu erkennen

Der „Configure“-Tab

Im Dienstprogramm des Blackmagic Audio Monitor 12G finden Sie zudem den „Configure“-Tab. Dieser enthält die Softwareversion sowie die Netzwerkeinstellungen Ihres Blackmagic Audio Monitors. Überdies können Sie Ihrem Gerät einen benutzerdefinierten Namen zuweisen, damit es auch bei Einsatz an einem anderen Ort leichter im Netzwerk auffindbar ist.

Benennung Ihres Blackmagic Audio Monitor 12G

So benennen Sie Ihren Blackmagic Audio Monitor 12G:

- 1 Klicken Sie auf den „Configure“-Tab.
- 2 Klicken Sie unter „Details“ in das Textfeld „Name“ und geben Sie eine neue Bezeichnung ein.
- 3 Zum Speichern klicken Sie auf „Save“.



Netzwerkeinstellungen ändern

Greifen Sie zur Verwaltung mehrerer Geräte am besten über ein Netzwerk auf Ihren Blackmagic Audio Monitor 12G zu. Dies funktioniert mit dem Blackmagic Audio Monitor Setup Dienstprogramm. Ihr Blackmagic Audio Monitor 12G ist standardmäßig so konfiguriert, dass er automatisch im Netzwerk erkannt und Ihnen unmittelbar auf dem Startbildschirm des Dienstprogramms angezeigt wird.

Sollte ein Blackmagic Audio Monitor 12G nicht in Ihrem Netzwerk erkannt werden, müssen Sie seine Netzwerkeinstellungen eventuell lokal ändern. Gleiches gilt für den Fall, dass Sie zuvor Einstellungen für eine statische Adresse vorgenommen haben, die nicht mit Ihrem aktuellen Netzwerk kompatibel ist. Dies können Sie per USB tun.

Netzwerkeinstellungen per USB ändern

Um die Netzwerkeinstellungen per USB anzupassen, schließen Sie Ihren Blackmagic Audio Monitor 12G mithilfe eines USB-Kabels an einen Computer an und starten Sie das Blackmagic Audio Monitor Dienstprogramm. Der USB-Anschluss Ihres Blackmagic Audio Monitor 12G befindet sich auf der Rückseite des Geräts. Wählen Sie als nächstes auf dem Startbildschirm des Blackmagic Audio Monitor Dienstprogramms Ihren Audio Monitor 12G aus und navigieren Sie zum „Configure“-Tab. Hier können Sie zwischen dynamischen und statischen Netzwerkadressen hin- und herschalten. Wenn Sie eine statische IP auswählen, können Sie die IP-Adresse, die Subnetz-Maske und das Gateway manuell konfigurieren.

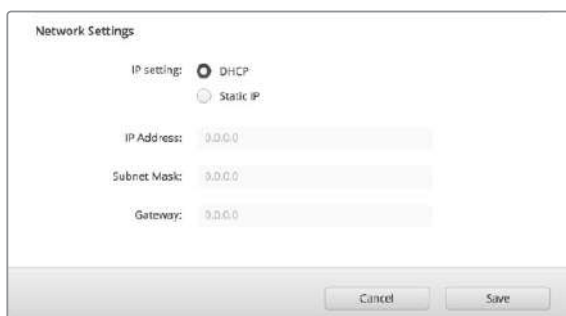

Installation des optionalen Blackmagic Dolby® Decoder Moduls

Dolby hat das Dolby Decoder Modul mittlerweile aus dem Sortiment genommen. Sollten Sie jedoch über den originalen Blackmagic Audio Monitor verfügen und ihn verwenden wollen, dann folgen Sie bitte den Installationsanweisungen auf dieser Seite.

HINWEIS Der Blackmagic Audio Monitor 12G bietet keine Unterstützung für das optionale Dolby Decoder Modul.

WARNHINWEIS

Vergewissern Sie sich vor Installation des Dolby Decoder Moduls, dass Ihr Blackmagic Audio Monitor vom Strom getrennt ist, da die Gehäuseabdeckung für die Installation entfernt werden muss, um auf die Hauptplatine zuzugreifen. Dieser Vorgang sollte ausschließlich von Fachpersonal durchgeführt werden. Um die Gefahr von elektrostatischen Entladungen während der Installation des Moduls zu reduzieren, sollten weitere Vorsichtsmaßnahmen getroffen werden.

Installation des Moduls

Die Installation eines Blackmagic Dolby Decoder Moduls ermöglicht Ihnen das Monitoring in Dolby Digital oder Dolby E, den in modernen Film- und Fernsehproduktionen eingesetzten Klangformaten. Dolby 5.1 Surround Sound wird mit den Tonkanälen links und rechts vorne, Surround links und rechts hinten, einem mittleren Kanal sowie mit einem Kanal für tiefe Bassfrequenzen verschlüsselt.

Der Dolby-Decoder ist ein 72-poliges SIMM-Modul, das sich mühelos auf den unbesetzten Steckplatz an der Hauptplatine des Blackmagic Audio Monitors aufstecken lässt.

So installieren Sie das Blackmagic Dolby Decoder Modul:

- 1** Vergewissern Sie sich, dass jegliche Stromzufuhr zum Blackmagic Audio Monitor unterbrochen ist.
- 2** Lösen Sie die 21 Schrauben der Gehäuseabdeckung des Blackmagic Audio Monitors mit einem Kreuzschlitzschraubendreher. Entfernen Sie die Abdeckung.
- 3** Richten Sie die Kontakte des Blackmagic Dolby Decoder Moduls auf den freien SIMM-Steckplatz aus. Die Nut des SIMM muss genau auf die Feder des Steckplatzes ausgerichtet sein, um vollständig zu arretieren.
- 4** Führen Sie das Modul vorsichtig in den SIMM-Steckplatz ein, bis die Kontakte fest im Steckplatz sitzen.
- 5** Neigen Sie das Modul in Richtung Rückseite des Blackmagic Audio Monitors, bis es an beiden Seiten unter den Metallklammern einrastet.
- 6** Legen Sie die Abdeckung des Blackmagic Audio Monitors wieder auf und ziehen Sie die 21 Schrauben an.

Befestigen Sie nach der Installation des Decoder-Moduls den mitgelieferten Dolby-Aufkleber an der Gehäuserückwand neben dem Warnhinweis. So ist erkennbar, dass ein Dolby-Modul installiert wurde.

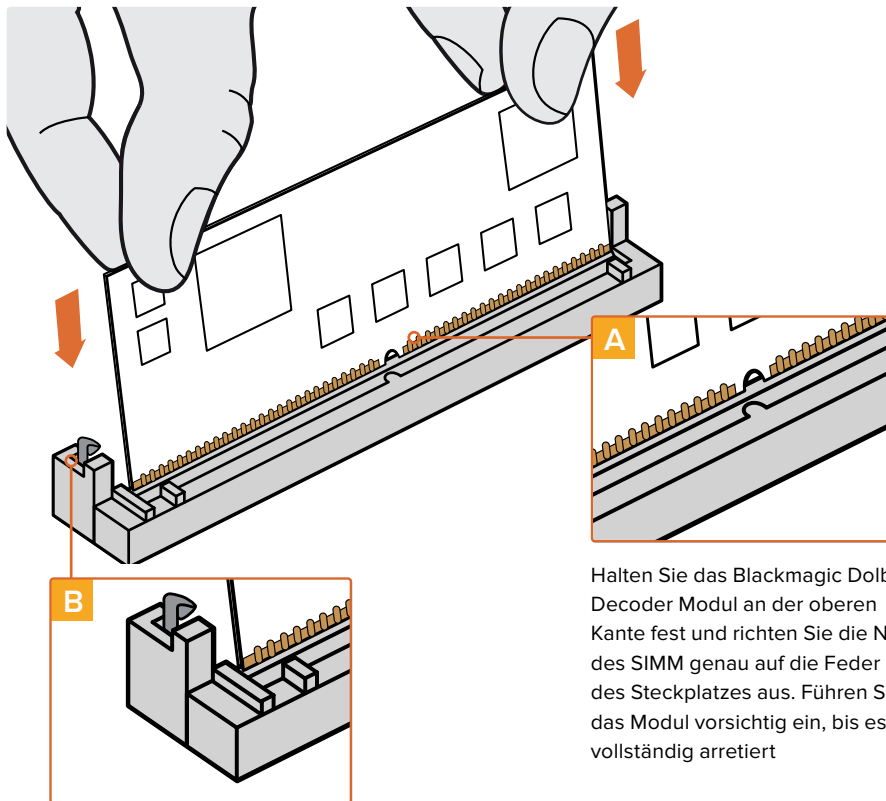

Halten Sie das Blackmagic Dolby Decoder Modul an der oberen Kante fest und richten Sie die Nut des SIMM genau auf die Feder des Steckplatzes aus. Führen Sie das Modul vorsichtig ein, bis es vollständig arretiert

Neigen Sie das Modul in Richtung Rückseite des Gehäuses, bis das Modul an beiden Seiten unter den Metallklammern einrastet

Bestätigung von Dolby Audio

Sobald der Blackmagic Audio Monitor Dolby-kodiertes Audio erkennt, erscheint das Dolby-Logo oben rechts auf dem LCD. Per Druck auf die Tasten „CH aufwärts“ und „CH abwärts“ an der Frontblende lassen sich vier Dolby-Surround-Kanalpaare überwachen.

Informationen für Entwickler (Englisch)

Controlling Blackmagic Audio Monitor 12G using Telnet

The Blackmagic Audio Monitor 12G Ethernet Protocol gives you the freedom to build your own custom control solutions for your Blackmagic Audio Monitor 12G. For example, you can create your own software application or web interface to control your Blackmagic Audio Monitor 12G via Ethernet from your computer.

The first step is to connect your Blackmagic Audio Monitor 12G to your computer via Ethernet. You can do this by connecting to the same network your computer is connected to, or you can connect Blackmagic Audio Monitor 12G directly to your computer.

NOTE If Blackmagic Audio Monitor 12G is connected directly to your computer, set your computer to a manual static IP address. Set the first three blocks of numbers in the IP address to match your Blackmagic Audio Monitor 12G and set the subnet mask to 255.255.255.0. You can leave the gateway or router setting blank as it will not be used in a direct connection between your computer and Blackmagic Audio Monitor 12G.

If your network settings are set correctly, you can now open the Terminal application on macOS, or enable Telnet command line utilities on Windows and enter Blackmagic Audio Monitor 12G Ethernet Protocol commands. These commands can be programmed into your application and triggered by related items on a custom user interface of your own design.

Using Telnet on macOS and Windows

- 1 On macOS, open the Terminal application which is located within the Applications > Utilities folder.
To open the command prompt in Windows, click on the 'start' menu and type 'cmd' in the search bar. Press 'enter'.

- 2 Type in "telnet" and a space followed by the IP address of your computer, then another space and "9996", which is the default port number for Blackmagic Audio Monitor 12G.

For example:

```
telnet 192.168.25.253 9996
```

Press 'enter'. The Protocol Preamble screen will appear.

Blackmagic Audio Monitor 12G Ethernet Protocol V1.0

Summary

The Blackmagic Audio Monitor 12G Ethernet Protocol is a text based protocol that is accessed by connecting to TCP port 9996 on a Blackmagic Audio Monitor 12G.

The Blackmagic Audio Monitor 12G sends information in blocks which each have an identifying header in all-caps, followed by a full-colon. A block spans multiple lines and is terminated by a blank line.

Each line in the protocol is terminated by a new line character.

Upon connection, the Blackmagic Audio Monitor 12G sends a complete dump of the state of the device. After the initial status dump, status updates are sent every time the Blackmagic Audio Monitor 12G status changes.

To be resilient to future protocol changes, clients should ignore blocks they do not recognize, up to the trailing blank line. Within existing blocks, clients should ignore lines they do not recognize.

Legend

↵ line feed or carriage return
... and so on

Version 1.0 of the Blackmagic Audio Monitor 12G Ethernet Protocol was released with Blackmagic Audio Monitor 12G 3.0 software.

Protocol Preamble

The first block sent by the Blackmagic Audio Monitor 12G is always the protocol preamble:

```
PROTOCOL PREAMBLE:  
Version: 1.0
```

The version field indicates the protocol version. When the protocol is changed in a compatible way, the minor version number will be updated. If incompatible changes are made, the major version number will be updated.

Device Information

The next block contains general information about the connected Blackmagic Audio Monitor 12G device. If a device is connected, the Blackmagic Audio Monitor 12G will report the attributes of the Blackmagic Audio Monitor 12G:

```
AUDIOMONITOR DEVICE:↵  
Model: Blackmagic Audio Monitor 12G  
Label: Blackmagic Audio Monitor 12G
```

Only the label can be modified.

```
AUDIOMONITOR DEVICE:↵  
Label: My new name↵  
↵
```

The response will be

```
ACK:  
AUDIOMONITOR DEVICE:  
Label: My new name
```

The next block will show the network settings which can only be changed via the Blackmagic Audio Monitor Setup utility when connected over USB. This is for information only.

```
NETWORK:  
Dynamic IP: 1  
Current address: 0.0.0.0  
Current subnet: 0.0.0.0  
Current gateway: 0.0.0.0
```

The next block is the meter type.

```
AUDIO METER:  
Meter Mode: VU (-20dBFS Ref)
```

This can be changed to VU (-20dBFS Ref), VU (-18dBFS Ref), PPM EBU (-20dBFS Ref), PPM EBU (-18dBFS Ref), PPM BBC (-20dBFS Ref), PPM BBC (-18dBFS Ref), Loudness (EBU +9 scale) or Loudness (EBU +18 scale)

```
AUDIO METER:↵  
Meter Mode: Loudness (EBU +18 scale)↵  
↵
```

The response will be

```
ACK:  
AUDIO METER:  
Meter Mode: Loudness (EBU +18 scale)
```

The next block is the input type.

```
AUDIO INPUT:  
Routing: Speaker Stereo SDI Stereo 1-2
```

This can be changed to SDI Stereo 3-4, SDI Stereo 5-6, SDI Stereo 7-8, SDI Stereo 9-10, SDI Stereo 11-12, SDI Stereo 13-14, SDI Stereo 15-16, XLR AES/EBU Stereo 1-2, XLR Analog Stereo or RCA Stereo

```
AUDIO INPUT:↵  
Routing: Speaker Stereo XLR AES/EBU Stereo 1-2↵  
↵
```

The response will be

```
ACK:  
AUDIO INPUT:  
Routing: Speaker Stereo XLR AES/EBU Stereo 1-2
```

The next block is the audio output state. This indicates the current headphone and speaker volume settings as well as the state of the mute and solo buttons.

```
AUDIO OUTPUT:  
Gain: Speaker Stereo 0  
Gain: Headphone Stereo 0  
Mute: false  
Solo: Off
```

The volume gain settings can be set between 0 and 255. Mute can be true or false and Solo can be Off, Left or Right

```
AUDIO OUTPUT:↵  
Gain: Speaker Stereo 125↵  
Solo: Right↵  
↵
```

The response will be

```
ACK:  
AUDIO OUTPUT:  
Gain: Speaker Stereo 125  
Solo: Right
```

Checking the Connection

While the connection to the Blackmagic Audio Monitor 12G is established, a client may send a special no-operation command to check that the Blackmagic Audio Monitor 12G is still responding:

```
PING:↵  
↵
```

If the Blackmagic Audio Monitor 12G is responding, it will respond with an ACK message as for any other recognized command.

Checking valid Protocol Commands

While the connection to the Blackmagic Audio Monitor 12G is established, a client may send a special HELP command to obtain a list of supported Telnet commands:

```
HELP:↵  
↵  
AUDIOMONITOR DEVICE:  
Model: <label> [read only]  
Label: <label>  
Unique ID: <label> [read only]  
  
NETWORK:  
Dynamic IP: <boolean> [read only]  
Current address: <IP_address> [read only]  
Current subnet: <IP_address> [read only]  
Current gateway: <IP_address> [read only]  
  
AUDIO METER:  
Meter Mode: <enum> -> <enum> = <"VU (-20dBFS Ref)" | "VU (-18dBFS Ref)" |  
"PPM EBU (-20dBFS Ref)" | "PPM EBU (-18dBFS Ref)" | "PPM BBC (-20dBFS Ref)"  
| "PPM BBC (-18dBFS Ref)" | "Loudness (EBU +9 scale)" | "Loudness (EBU  
+18 scale)">;  
  
AUDIO INPUT:  
Routing: <enum1> <enum2> -> <enum1> = <"Speaker Stereo">; <enum2> = <"SDI  
Stereo 1-2" | "SDI Stereo 3-4" | "SDI Stereo 5-6" | "SDI Stereo 7-8" | "SDI  
Stereo 9-10" | "SDI Stereo 11-12" | "SDI Stereo 13-14" | "SDI Stereo 15-16" |  
"XLR AES/EBU Stereo 1-2" | "XLR Analog Stereo" | "RCA Stereo">;  
  
AUDIO OUTPUT:  
Gain: <enum> <integer> -> <enum> = <"Speaker Stereo" | "Headphone Stereo">;  
<integer> = <0..255>;  
  
Mute: <boolean> -> <boolean> = <true | false>;  
  
Solo: <enum> -> <enum> = <"Off" | "Left" | "Right">;
```

Hilfe

Hilfestellung

Am schnellsten erhalten Sie Hilfe online über die Support-Seiten der Website von Blackmagic Design. Sehen Sie dort nach dem aktuellsten Support-Material für Ihren Blackmagic Audio Monitor.

Blackmagic Design Online-Support-Seiten

Die aktuellsten Versionen der Bedienungsanleitung, Produktsoftware und Support-Hinweise finden Sie im Blackmagic Support Center unter www.blackmagicdesign.com/de/support.

Blackmagic Design Forum

Das Blackmagic Design Forum auf unserer Website ist eine praktische Ressource, die Sie für mehr Information und kreative Ideen aufsuchen können. Manchmal finden Sie dort schnellere Lösungen, da möglicherweise bereits Antworten auf ähnliche Fragen von anderen erfahrenen Anwendern und Blackmagic Design Mitarbeitern vorliegen, die Ihnen weiterhelfen. Das Forum finden Sie unter <http://forum.blackmagicdesign.com>.

Kontaktaufnahme mit dem Blackmagic Design Support

Wenn unser Support-Material oder das Forum Ihnen nicht wie gewünscht hilft, gehen Sie bitte auf unsere Support-Seite und schicken Sie uns Ihre Anfrage über „Senden Sie uns eine E-Mail“. Oder klicken Sie auf „Finden Sie Ihr lokales Support-Team“ und rufen Sie Ihre nächstgelegene Blackmagic Design Support Stelle an.

Überprüfen der aktuell installierten Softwareversion

Um zu überprüfen, welche Version des Blackmagic Audio Monitor Setup aktuell auf Ihrem Computer installiert ist, öffnen Sie das Fenster „About Blackmagic Audio Monitor Setup“.

- Auf macOS: Gehen Sie zum Programme-Ordner und öffnen Sie Blackmagic Audio Monitor Setup. Klicken Sie dann in der Menüleiste auf „About Blackmagic Audio Monitor Setup“, um die Versionsnummer anzuzeigen.
- Auf Windows 10: Öffnen Sie das Blackmagic Audio Monitor Setup über die Kachel „Blackmagic Audio Monitor Setup“ auf Ihrem Startbildschirm. Klicken Sie auf den Menüpunkt „Hilfe“ und wählen Sie „About Blackmagic Audio Monitor Setup“ aus, um die Versionsnummer anzuzeigen.

So erhalten Sie die aktuellsten Software-Updates

Sehen Sie, sobald Sie die Version von Blackmagic Audio Monitor Setup überprüft haben, im Blackmagic Design Support Center unter www.blackmagicdesign.com/de/support nach den neuesten Aktualisierungen. In der Regel empfiehlt es sich, die neuesten Updates zu laden. Vermeiden Sie jedoch Software-Updates mitten in einem wichtigen Projekt.

Gesetzliche Vorschriften

Entsorgung von elektrischen und elektronischen Geräten innerhalb der Europäischen Union



Das auf dem Produkt abgebildete Symbol weist darauf hin, dass dieses Gerät nicht zusammen mit anderen Abfallstoffen entsorgt werden darf. Altgeräte müssen daher zur Wiederverwertung an eine dafür vorgesehene Sammelstelle übergeben werden. Mülltrennung und Wiederverwertung von Altgeräten tragen zum nachhaltigen Umgang mit natürlichen Ressourcen bei. Gleichzeitig wird sichergestellt, dass die Wiederverwertung nicht zulasten der menschlichen Gesundheit und der Umwelt geht. Weitere Informationen zur Entsorgung von Altgeräten sowie zu den Standorten der zuständigen Sammelstellen erhalten Sie von Ihren örtlichen Müllentsorgungsbetrieben sowie vom Händler, bei dem Sie dieses Produkt erworben haben.



Dieses Gerät wurde geprüft und entspricht den Grenzwerten für Digitalgeräte der Klasse A gemäß Abschnitt 15 der FCC-Bestimmungen für Funkstörung. Diese Grenzwerte dienen dem angemessenen Schutz gegen schädliche Störungen bei Betrieb des Geräts in einer gewerblichen Umgebung. Geräte dieser Art erzeugen und verwenden Hochfrequenzen und können diese auch ausstrahlen. Bei Nichteinhaltung der Installations- und Gebrauchsvorschriften können sie zu Störungen beim Rundfunkempfang führen. Der Betrieb solcher Geräte in Wohngebieten führt mit großer Wahrscheinlichkeit zu Funkstörungen. In diesem Fall kann vom Betreiber verlangt werden, persönlich für die Beseitigung solcher Störungen aufzukommen.

Der Betrieb unterliegt den folgenden zwei Bedingungen:

- 1 Dieses Gerät darf keine schädigenden Störungen hervorrufen.
- 2 Das Gerät muss unanfällig gegenüber beliebigen empfangenen Störungen sein, einschließlich solcher, die einen unerwünschten Betrieb verursachen.

ISED-Zertifizierung für den kanadischen Markt

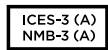

Dieses Gerät erfüllt die kanadischen Vorschriften für digitale Geräte der Klasse A.

Jedwede an diesem Produkt vorgenommene Änderung oder unsachgemäße Verwendung kann die Konformitätserklärung zum Erlöschen bringen.

Die Verbindung zu HDMI-Schnittstellen muss über hochwertige abgeschirmte HDMI-Kabel hergestellt werden.

Dieses Gerät wurde auf die Einhaltung der Richtlinien für die zweckbestimmte Nutzung im gewerblichen Bereich getestet. Bei Verwendung in häuslichen Umgebungen können Funkstörungen auftreten.

Sicherheitshinweise

Zum Schutz vor Stromschlag muss das Gerät an ein vorschriftsmäßig geerdetes Stromnetz angeschlossen werden. Kontaktieren Sie im Zweifelsfall einen Elektrofachmann.

Um das Risiko eines Stromschlages zu verringern, setzen Sie das Gerät weder Tropfen noch Spritzern aus.

Das Produkt eignet sich für den Einsatz in tropischen Gebieten mit einer Umgebungstemperatur von bis zu 40 °C.

Achten Sie auf eine ausreichende Luftzufuhr um das Gerät herum, damit die Belüftung nicht eingeschränkt wird.

Achten Sie bei der Installation im Rack darauf, dass die Luftzufuhr nicht durch andere Geräte eingeschränkt wird.

Es befinden sich keine vom Anwender zu wartenden Teile im Inneren des Produkts. Wenden Sie sich für die Wartung an ein Blackmagic Design Service-Center in Ihrer Nähe.



Nur in Höhen bis 2000 m über dem Meeresspiegel einsetzen.

California Proposition 65

Plastikteile dieses Produkts können Spuren von polybromierten Biphenylen enthalten. Im US-amerikanischen Bundesstaat Kalifornien werden diese Chemikalien mit Krebs, Geburtsfehlern und anderen Schäden der Fortpflanzungsfähigkeit in Verbindung gebracht.

Weitere Informationen finden Sie unter www.P65Warnings.ca.gov.

Garantie

12 Monate eingeschränkte Garantie

Für dieses Produkt gewährt Firma Blackmagic Design eine Garantie auf Material- und Verarbeitungsfehler von 12 Monaten ab Kaufdatum. Sollte sich ein Produkt innerhalb dieser Garantiezeit als fehlerhaft erweisen, wird die Firma Blackmagic Design nach ihrem Ermessen das defekte Produkt entweder ohne Kostenerhebung für Teile und Arbeitszeit reparieren oder Ihnen das defekte Produkt ersetzen.

Zur Inanspruchnahme der Garantieleistungen müssen Sie als Kunde Blackmagic Design über den Defekt innerhalb der Garantiezeit in Kenntnis setzen und die entsprechenden Vorkehrungen für die Leistungserbringung treffen. Es obliegt dem Kunden, für die Verpackung und den bezahlten Versand des defekten Produkts an ein spezielles von Blackmagic Design benanntes Service Center zu sorgen und hierfür aufzukommen. Sämtliche Versandkosten, Versicherungen, Zölle, Steuern und sonstige Abgaben im Zusammenhang mit der Rücksendung von Waren an uns, ungeachtet des Grundes, sind vom Kunden zu tragen.

Diese Garantie gilt nicht für Mängel, Fehler oder Schäden, die durch unsachgemäße Handhabung oder unsachgemäße oder unzureichende Wartung und Pflege verursacht wurden. Blackmagic Design ist im Rahmen dieser Garantie nicht verpflichtet, die folgenden Serviceleistungen zu erbringen: a) Behebung von Schäden infolge von Versuchen Dritter, die Installation, Reparatur oder Wartung des Produkts vorzunehmen, b) Behebung von Schäden aufgrund von unsachgemäßer Handhabung oder Anschluss an nicht kompatible Geräte, c) Behebung von Schäden oder Störungen, die durch die Verwendung von nicht Blackmagic-Design-Ersatzteilen oder -Verbrauchsmaterialien entstanden sind, d) Service für ein Produkt, das verändert oder in andere Produkte integriert wurde, sofern eine solche Änderung oder Integration zu einer Erhöhung des Zeitaufwands oder zu Schwierigkeiten bei der Wartung des Produkts führt. ÜBER DIE IN DIESER GARANTIEERKLÄRUNG AUSDRÜCKLICH AUFGEFÜHRTEN ANSPRÜCHE HINAUS ÜBERNIMMT BLACKMAGIC DESIGN KEINE WEITEREN GARANTIEEN, WEDER AUSDRÜCKLICH NOCH STILLSCHWEIGEND. DIE FIRMA BLACKMAGIC DESIGN UND IHRE HÄNDLER LEHNEN JEDLICHE STILLSCHWEIGENDEN GARANTIEEN IN BEZUG AUF AUSSAGEN ZUR MARKTGÄNGIGKEIT UND GEBRAUCHSTAUGLICHKEIT FÜR EINEN BESTIMMTEN ZWECK AB. DIE VERANTWORTUNG VON BLACKMAGIC DESIGN, FEHLERHAFTER PRODUKTE ZU REPARIEREN ODER ZU ERSETZEN, IST DIE EINZIGE UND AUSSCHLIESSLICHE ABHILFE, DIE GEGENÜBER DEM KUNDEN FÜR ALLE INDIREKTEN, SPEZIELLEN, NEBEN- ODER FOLGESCHÄDEN ZUR VERFÜGUNG GESTELLT WIRD, UNABHÄNGIG DAVON, OB BLACKMAGIC DESIGN ODER DER HÄNDLER VON DER MÖGLICHKEIT SOLCHER SCHÄDEN ZUVOR IN KENNTNIS GESETZT WURDE. BLACKMAGIC DESIGN IST NICHT HAFTBAR FÜR JEDLICHE WIDERRECHTLICHE VERWENDUNG DER GERÄTE DURCH DEN KUNDEN. BLACKMAGIC HAFTET NICHT FÜR SCHÄDEN, DIE SICH AUS DER VERWENDUNG DES PRODUKTS ERGEBEN. NUTZUNG DES PRODUKTS AUF EIGENE GEFAHR.

© Copyright 2020 Blackmagic Design. Alle Rechte vorbehalten. „Blackmagic Design“, „DeckLink“, „HDLink“, „Workgroup Videohub“, „Multibridge Pro“, „Multibridge Extreme“, „Intensity“ und „Leading the creative video revolution“ sind eingetragene Warenzeichen in den USA und anderen Ländern. Alle anderen Unternehmens- und Produktnamen sind möglicherweise Warenzeichen der jeweiligen Firmen, mit denen sie verbunden sind.



Manual de instalación y funcionamiento

Blackmagic Audio Monitor 12G

Enero 2020

Español



Bienvenido

Gracias por haber adquirido este producto.

Ojalá compartas nuestro sueño de transformar la industria televisiva en un sector verdaderamente creativo, donde todos tengan acceso a la mejor calidad en materia de imagen.

En cualquier dinámica de trabajo, es fundamental monitorizar el audio, ya sea durante la transmisión, la posproducción o la producción en directo. El dispositivo Blackmagic Audio Monitor ofrece todas las herramientas necesarias para supervisar señales de audio de manera profesional en un diseño modular compacto. Asimismo, se puede conectar prácticamente a cualquier clase de equipos para realizar un seguimiento de gran calidad. El modelo original incluye tecnología SDI 6G para procesar imágenes UHD a una frecuencia máxima de 30 f/s. Por otro lado, la versión Blackmagic Audio Monitor 12G admite SDI 12G para contenidos UHD a una frecuencia máxima de 60 f/s, así como señales SDI 3G (nivel A/B).

Este manual de instrucciones brinda toda la información necesaria sobre el producto.

En la página de soporte técnico de nuestro sitio web encontrarás su versión más reciente, así como actualizaciones para el software interno del dispositivo. Recuerda mantenerlo actualizado para tener acceso a nuevas prestaciones. Por último, no olvides registrarte al descargar las actualizaciones para que podamos mantenerte informado sobre nuevos lanzamientos. Trabajamos constantemente para desarrollar herramientas innovadoras y superarnos, de modo que nos encantaría conocer tu opinión.

A handwritten signature in black ink that reads "Grant Petty". The signature is written in a cursive, flowing style.

Grant Petty

Director ejecutivo de Blackmagic Design

Contenido

Blackmagic Audio Monitor 12G

Primeros pasos	93
Introducción	93
Conexiones de audio	93
Selección de fuentes de audio	94
Salidas de video	94
Uso del dispositivo	95
Panel de control	95
Pantalla LCD	95
Indicadores de volumen	95
Asilar canal izquierdo o derecho	96
Selección de canales	96
Entrada	97
Silenciar	97
Volumen	97
Configuración	98
Blackmagic Audio Monitor Setup	98
Instalación en equipos macOS	98
Instalación en equipos Windows	98
Actualización del software interno	98
Pestaña «Meter»	99
Pestaña «Configure»	101
Modificación de los ajustes de red	101
Instalación del módulo Blackmagic Dolby®	102
Instalación del módulo	102
Confirmación del sonido Dolby®	103
Información para desarrolladores	104
Control del modelo Blackmagic Audio Monitor 12G mediante Telnet	104
Protocolo de Ethernet (versión 1.0)	104
Ayuda	108
Normativas	109
Seguridad	110
Garantía	111

Primeros pasos

Introducción

Los dispositivos Blackmagic Audio Monitor y Blackmagic Audio Monitor 12G brindan una solución modular para bastidores que permite supervisar señales de audio en tiempo real. Resultan ideales para monitorizar distintas fuentes audiovisuales en toda clase de entornos, durante transmisiones en directo o en la etapa de posproducción.

Estos equipos disponen de tecnología SDI compatible con distintas definiciones y velocidades de transmisión, así como conexiones para señales de audio analógicas y digitales (AES/EBU), a fin de garantizar un volumen adecuado. El modelo 12G es compatible con señales SDI UHD a una frecuencia máxima de 60 f/s. Los indicadores luminosos para el canal izquierdo y derecho brindan la posibilidad de evitar la saturación del audio, mientras que la pantalla integrada muestra la señal SDI y otros datos importantes, tales como el tipo de conexión, el formato, la frecuencia de imagen, los canales de audio y la intensidad del volumen.

De esta manera, es posible supervisar hasta 16 canales de audio integrados en la señal SDI o utilizar las conexiones XLR para audio balanceado analógico y digital (AES/EBU). Por su parte, los conectores RCA brindan compatibilidad con equipos de consumo masivo, tales como iPods y sistemas de alta fidelidad.

Este dispositivo incluye dos altavoces internos de gran calidad y dos altavoces para sonidos graves que ofrecen una gran variedad de frecuencias y permiten obtener un sonido claro y profundo. También es posible conectar auriculares para supervisar el audio en forma confiable, especialmente en ambientes ruidosos.



Panel frontal del modelo Blackmagic Audio Monitor 12G



Panel trasero del modelo Blackmagic Audio Monitor 12G

Conexiones de audio

El modelo Blackmagic Audio Monitor es compatible prácticamente con cualquier equipo de audio. Para procesar señales SDI en definición SD, HD, 2K e incluso UHD, es posible conectarlo mediante un cable BNC estándar. La versión 12G también admite señales SDI 3G (nivel A/B).

Asimismo, las entradas XLR brindan la posibilidad de monitorizar señales de audio en formato AES/EBU o analógico provenientes de distintos equipos, tales como grabadores, consolas de audio digitales, mezcladores de audio o unidades Betacam SP. A su vez, es posible conectar videograbadores o reproductores de DVD convencionales mediante las conexiones RCA. Por otro lado, incluye un puerto TRS de 0.25 pulgadas para utilizar auriculares cuando es necesario escuchar el audio sin causar molestias a otras personas.

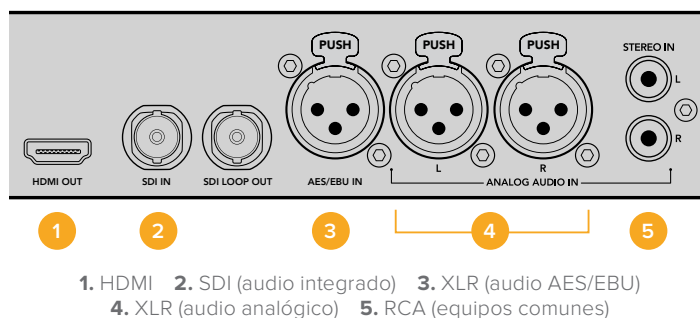

Selección de fuentes de audio

Después de conectar un equipo al dispositivo, es posible seleccionar la fuente presionando el botón **INPUT** en el panel de control. Si la señal incluye canales de audio, verá los vúmetros en funcionamiento. Estos indicadores están constituidos por dos filas de ledes que se encienden para confirmar la recepción de la señal.

El botón **INPUT** permite alternar entre las distintas señales de audio, indicadas en la pantalla LCD junto con la información sobre el tipo de entrada, los canales de audio y el volumen. Esto es todo lo que se necesita saber para comenzar a utilizar el dispositivo.

Salidas de video

En caso de que sea necesario realizar un seguimiento de las imágenes además del audio, estas salidas permiten monitorizarlas en pantallas de gran tamaño o conectar otros dispositivos.

Las salidas HDMI y SDI derivadas pueden utilizarse para supervisar señales con audio integrado. Por otro lado, es posible utilizar dispositivos de captura SD, HD, 2K e incluso UHD 4K, tales como la tarjeta DeckLink 4K Extreme, mediante un único cable SDI. Asimismo, la tecnología SDI SD/HD permite procesar canales de audio integrados y conectar grabadores, por ejemplo el modelo HyperDeck Studio, mientras que el puerto HDMI brinda compatibilidad con pantallas y proyectores UHD.

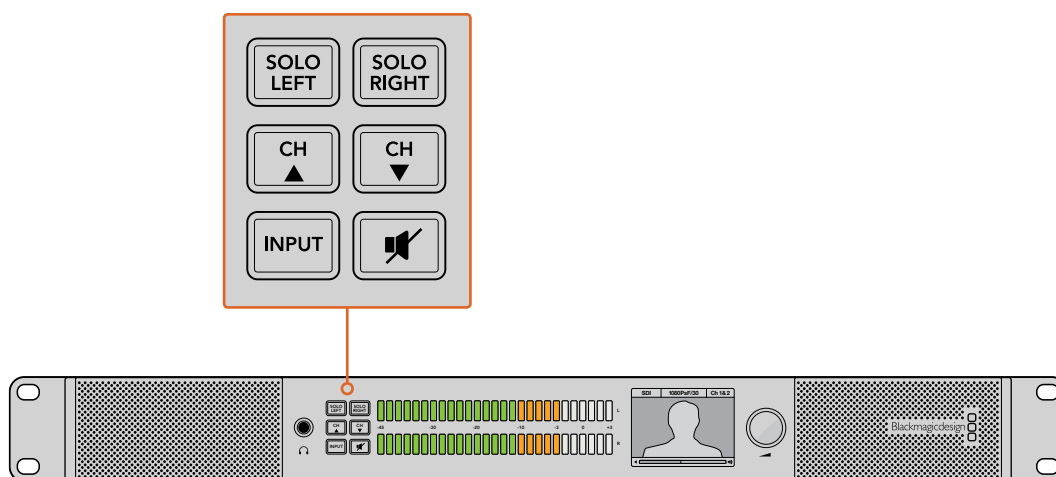

Estos botones permiten seleccionar la señal entrante que se desea monitorizar, aislar los canales estéreo (izquierdo y derecho), ver los canales audio disponibles y silenciar los altavoces o los auriculares.

Uso del dispositivo

Panel de control

El panel de control permite acceder rápidamente a información y funciones importantes.

Pantalla LCD

La pantalla de cristal líquido integrada cuenta con una función de texto superpuesto que muestra datos relevantes, entre ellos la entrada seleccionada, el formato de la imagen cuando hay una conexión SDI activa, los canales de audio seleccionados y el volumen de los altavoces o auriculares. La pantalla también mostrará la señal SDI recibida. En caso de que no se detecte ninguna señal, aparecerá un ícono con una nota musical.

Para cada entrada seleccionada, se muestra la siguiente información:

Entrada SDI

SDI, formato de imagen, canales de audio seleccionados.

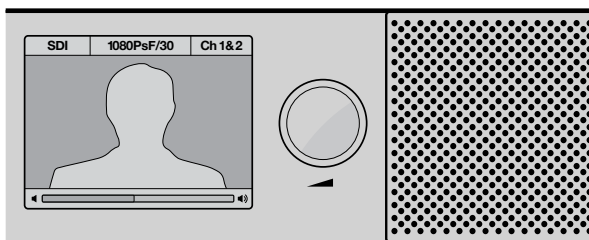

La pantalla de cristal líquido muestra información sobre el audio y las imágenes, inclusive el tipo de conexión, el formato, los canales de audio seleccionados y el volumen.

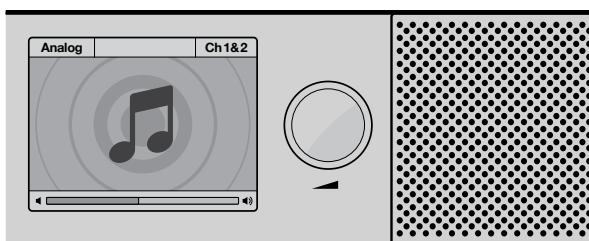

La pantalla muestra una nota musical si no se detecta una señal de video conectada.

Entrada XLR para audio AES/EBU balanceado

AES/EBU, canales de audio seleccionados.

Entradas XLR para audio analógico

Analog, canales de audio seleccionados.

Entradas RCA para audio analógico no balanceado

HiFi, canales de audio seleccionados.

Indicadores de volumen

La intensidad de la señal se muestra mediante dos filas de indicadores luminosos de color verde, naranja y rojo. Si se encienden todas las luces, el volumen está demasiado alto y puede ocurrir una distorsión en la señal.

El comportamiento del vúmetro digital varía en función del tipo de medición seleccionado al configurar el dispositivo. Para obtener la mejor calidad de audio, es necesario ajustar el volumen del equipo conectado al dispositivo, de forma que no supere los 0 dB. De este modo se maximiza la intensidad de la señal con relación al ruido, garantizando la nitidez del sonido. Si el audio supera dicho valor, es muy posible que ocurra una distorsión.

Consulte el apartado *Configuración* para obtener más información al respecto.

Asilar canal izquierdo o derecho

Los botones **SOLO LEFT** y **SOLO RIGHT** permiten aislar el canal izquierdo o derecho, a fin de detectar posibles problemas en cada uno de ellos en forma independiente.

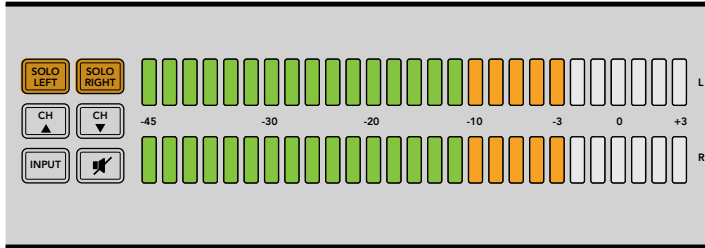

Al presionar el botón **SOLO LEFT** se desactiva el canal derecho. El vúmetro continuará mostrando la intensidad del volumen en ambos canales.

Para supervisar el audio del canal izquierdo:

- 1 Presione el botón **SOLO LEFT**. Este se encenderá y el audio se reproducirá por el altavoz izquierdo solamente.
- 2 Presione **SOLO LEFT** nuevamente para retornar al modo estéreo.

Para supervisar el audio del canal derecho:

- 1 Presione el botón **SOLO RIGHT**. Este se encenderá y el audio se reproducirá por el altavoz derecho solamente.
- 2 Presione **SOLO RIGHT** nuevamente para retornar al modo en estéreo.

Selección de canales

Estos botones permiten alternar entre los canales de audio integrados a la conexión SDI. Incluye hasta 16 canales u 8 pares en SDI 3G. Presione los botones para desplazarse hacia arriba o abajo por los canales de audio SDI integrados.

El dispositivo es compatible con tecnología SDI 12G que ofrece hasta 64 canales de audio o 32 pares. Mantenga presionados los botones para desplazarse hacia arriba o abajo por todos los canales.

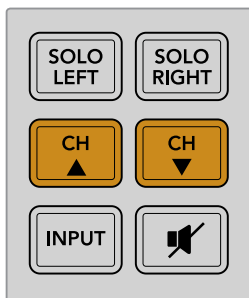

Entrada

Al presionar varias veces el botón **INPUT**, es posible cambiar las entradas para seleccionar la señal que se desea monitorizar.

La fuente seleccionada se escuchará por los altavoces, y además es posible monitorizar el audio en los canales 1 y 2 de la señal HDMI transmitida.

NOTA: La salida HDMI transmitirá una imagen en negro al seleccionar las entradas AES/EBU, HiFi o para audio analógico. La salida SDI derivada siempre transmite la fuente conectada a la entrada SDI.

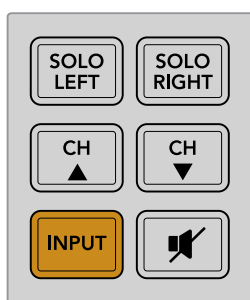

Silenciar

El botón **MUTE** permite silenciar los altavoces del panel de control y los auriculares. Al presionarlo solo se verán afectados los altavoces y auriculares, no así el audio entrante. Oprima este botón nuevamente para restablecer el audio. De forma alternativa, el sonido también puede volver a escucharse subiendo el volumen.

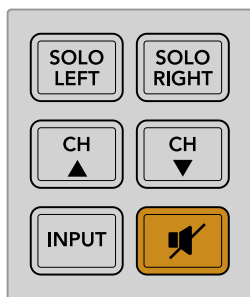

Volumen

Esta perilla permite ajustar el volumen de los altavoces y auriculares independientemente. El nivel se indica en la pantalla integrada. Cuando los auriculares están conectados, el sonido se transmite a través de ellos y no mediante los altavoces del equipo. El volumen puede subirse o bajarse fácilmente girando la perilla hacia la izquierda o la derecha.

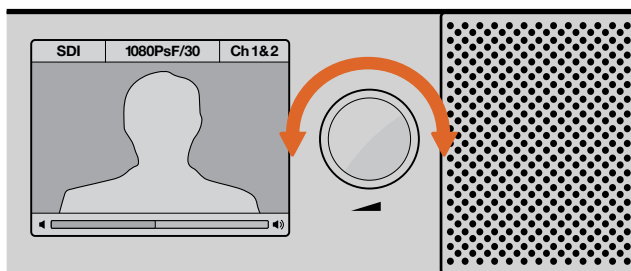

El volumen se indica en la pantalla del panel de control.

Configuración

Blackmagic Audio Monitor Setup

El programa utilitario Audio Monitor Setup permite configurar el tipo de vúmetro que se desea utilizar y actualizar el dispositivo.

El programa se puede instalar desde la tarjeta SD incluida, aunque recomendamos descargar la última versión desde nuestra página de soporte técnico.

Al conectar el dispositivo Blackmagic Audio Monitor al puerto USB de un equipo informático, se brinda la posibilidad de cambiar los ajustes de configuración y actualizar el software interno. En el modelo Blackmagic Audio Monitor 12G, es posible hacer esto a través de una red Ethernet. Sin embargo, para modificar los ajustes de red, aún será necesario conectarlo mediante el puerto USB.

El programa utilitario es compatible con la versión Mojave 10.14 (o posterior) de macOS y Windows 10.

Instalación en equipos macOS

- 1 Haga doble clic en el archivo de instalación proporcionado con el dispositivo o situado en la carpeta de descargas si ha obtenido el programa desde nuestro sitio web.
- 2 Siga las instrucciones para instalar el programa.

Instalación en equipos Windows

- 1 Haga doble clic en el archivo de instalación proporcionado con el dispositivo o situado en la carpeta de descargas si ha obtenido el programa desde nuestro sitio web.
- 2 Siga las instrucciones y acepte los términos de la licencia para que el sistema operativo instale el programa automáticamente.

Actualización del software interno

- 1 Conecte el dispositivo a un equipo informático mediante el puerto USB o Ethernet.
- 2 Ejecute el programa Audio Monitor Setup.
- 3 Al hacer clic en el ícono de configuración, el programa indicará si es necesario realizar una actualización.
- 4 En caso afirmativo, haga clic en el botón **Update** para dar inicio al proceso.



Haga clic en el botón **Update** para actualizar el software interno.

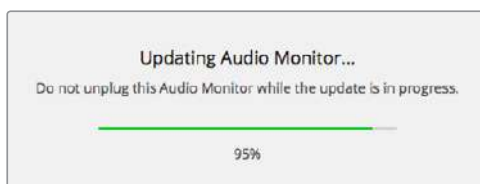

Una barra indica el progreso de la actualización.

- Haga clic en el botón **Close** al finalizar la actualización.

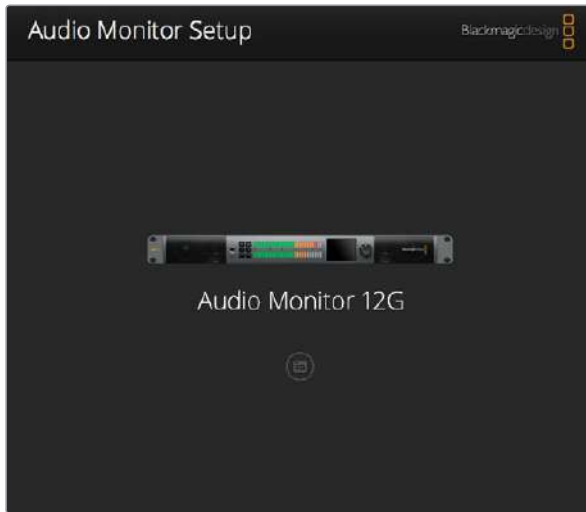

El programa utilitario Audio Monitor Setup permite actualizar el software interno y cambiar los ajustes de configuración del dispositivo.

Pestaña «Meter»

En el programa utilitario, haga clic en el ícono de configuración a fin de ver las opciones disponibles para los indicadores de volumen. Es posible seleccionar tres escalas de medición distintas. Si bien el vúmetro (VU) es una herramienta estandarizada, el picómetro (PPM) y el control de sonoridad (loudness) utilizan diferentes escalas (EBU o BBC) y rangos de medición para indicar el volumen percibido. El dispositivo Audio Monitor es compatible con los siguientes tipos de indicadores y escalas de medición:

Indicador	Escala	Rango de medición	Presentación
VU	–	-45 a +3	Impreso en el dispositivo
PPM	EBU	-12 a +12	Rótulo adhesivo
PPM	BBC	1 a 7	Rótulo adhesivo
Loudness	EBU +9	-18 a +9	Rótulo adhesivo
Loudness	EBU +18	-36 a +18	Rótulo adhesivo
Loudness	Escala completa +9	-41 a -14	Rótulo adhesivo
Loudness	Escala completa +18	-59 a -5	Rótulo adhesivo

Vúmetro

Indica el nivel promedio máximo y mínimo de la señal de audio. Generalmente se utiliza para monitorizar los picos, aunque también permite supervisar la sonoridad percibida debido a su capacidad para determinar los valores medios.

Picómetro

Indica durante varios segundos el nivel máximo de la señal para determinar con exactitud el punto de saturación del audio.

Sonoridad

Muestra la percepción subjetiva de la audibilidad de la señal. Los estándares profesionales de difusión audiovisual en la actualidad incluyen este tipo de indicador para obtener una intensidad de audio consistente.

Tanto el vúmetro como el picómetro permiten seleccionar el nivel de referencia (-18 dB o -20 dB) para cerciorarse de que la señal de audio se ajuste a los diversos estándares de teledifusión internacionales.

Los ledes del dispositivo se iluminan de manera diferente en función del tipo de medidor seleccionado. Por otro lado, a fin de facilitar la identificación exacta del valor de saturación, se proporcionan rótulos adhesivos con distintas escalas de referencia en decibeles. Pegue el rótulo requerido entre las dos filas de ledes, de manera que cubra la escala correspondiente al vúmetro impresa en el dispositivo.

Se incluyen dos rótulos para cada tipo de medidor y escala, aunque también es posible adquirir otros en cualquier distribuidor de productos Blackmagic. Visite en la página de soporte técnico de Blackmagic Design para encontrar el centro de atención más cercano.



Seleccione el tipo de indicador deseado y, a continuación, haga clic en el botón **Save**.

EBU PPM									
-12	-8	-4	0	+4	+8	+12			
-12	-8	-4	0	+4	+8	+12			
BBC PPM									
1	2	3	4	5	6	7			
1	2	3	4	5	6	7			
Loudness Units EBU +9dB									
-18	-15	-12	-9	-6	-3	0	+3	+6	+9
-18	-15	-12	-9	-6	-3	0	+3	+6	+9
Loudness Units Fullscale +9dB									
-41	-38	-35	-32	-29	-26	-23	-20	-17	-14
-41	-38	-35	-32	-29	-26	-23	-20	-17	-14
Loudness Units EBU +18dB									
-36	-30	-24	-18	-12	-6	0	+6	+12	+18
-36	-30	-24	-18	-12	-6	0	+6	+12	+18
Loudness Units Fullscale +18dB									
-59	-53	-47	-41	-35	-29	-23	-17	-11	-5
-59	-53	-47	-41	-35	-29	-23	-17	-11	-5

Los rótulos adhesivos permiten identificar en forma precisa el punto de saturación del audio en las distintas escalas.

Pestaña «Configure»

Para el modelo Blackmagic Audio Monitor 12G, el programa cuenta con una pestaña adicional, la cual indica el número de versión del software y los ajustes de red del dispositivo. Además, es posible asignarle un nombre personalizado, lo cual ayuda a ubicar el equipo con mayor facilidad cuando está conectado de forma remota.

Asignación de nombre al dispositivo

Para asignar un nombre al dispositivo:

- 1 Haga clic en la pestaña **Configure**.
- 2 En la sección **Details**, haga clic sobre el cuadro de texto correspondiente al nombre y escriba uno nuevo.
- 3 Haga clic en **Save**.



Modificación de los ajustes de red

La forma más sencilla de configurar el dispositivo Blackmagic Audio Monitor 12G es accediendo a este a través de una red, mediante la aplicación Audio Monitor Setup. De manera predeterminada, este modelo está configurado para obtener una dirección de red automáticamente. De este modo, resulta sencillo seleccionarlo en la pantalla de inicio del programa utilitario.

Si no es posible encontrar un modelo específico en la red o si se le ha asignado una dirección fija incompatible, quizá sea necesario modificar los ajustes de red en el dispositivo mediante el puerto USB.

Modificación de los ajustes de red mediante el puerto USB

Para modificar la configuración del modelo Blackmagic Audio Monitor 12G a través de la conexión USB, es preciso conectar el dispositivo a un equipo informático. El puerto USB se encuentra en la parte trasera de la unidad. Una vez conectado, seleccione el modelo correspondiente en la pantalla de inicio del programa y haga clic en la pestaña **Configure**. Desde allí es posible alternar entre direcciones fijas y dinámicas. Si selecciona una fija, es posible configurar manualmente la dirección, la máscara de subred y el puerto de enlace.

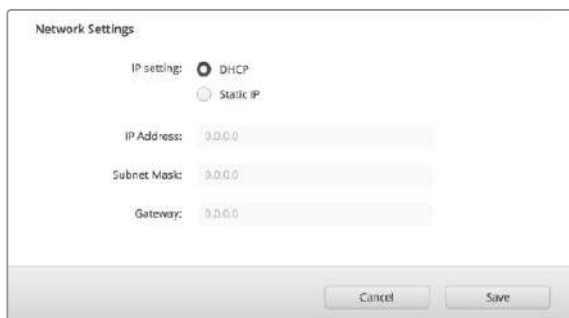

Instalación del módulo Blackmagic Dolby®

Dolby ha suspendido la fabricación de este decodificador. No obstante, si cuenta con uno de estos dispositivos y desea instalarlo en el modelo original, siga las instrucciones descritas a continuación.

NOTA: El modelo Blackmagic Audio Monitor 12G no es compatible con el decodificador Dolby opcional.

ADVERTENCIA

Asegúrese de desconectar la fuente de alimentación del dispositivo antes de instalar el decodificador, dado que, durante este procedimiento, es preciso retirar la cubierta de la unidad para acceder a la placa base. La instalación solo debe ser realizada por personas calificadas. Asimismo, se deben tomar las precauciones necesarias para reducir el riesgo de descarga eléctrica al instalar el módulo.

Instalación del módulo

Al instalar el módulo, es posible monitorizar el audio en formato Dolby Digital o Dolby E que se emplea en las producciones cinematográficas y televisivas modernas. El sonido Dolby 5.1 envolvente se codifica mediante los canales frontales (izquierdo y derecho), los canales traseros envolventes (izquierdo y derecho), un canal central y otro para frecuencias graves.

El decodificador Dolby es un módulo de 72 pines que se instala fácilmente en la ranura SIMM de la placa base del Audio Monitor.

Para instalar el módulo:

- 1 Compruebe que el dispositivo esté desconectado de la fuente de alimentación.
- 2 Quite los tornillos de la tapa utilizando un destornillador Phillips. Retire la tapa.
- 3 Sostenga el módulo con los contactos orientados hacia la ranura SIMM. Para colocarlo, el orificio del módulo debe estar alineado con la pestaña en la ranura.
- 4 Inserte el módulo con cuidado en la ranura SIMM hasta que los contactos queden firmes.
- 5 Incline el módulo hacia la parte posterior del dispositivo hasta que ambos lados queden sujetos mediante las trabas metálicas.
- 6 Coloque la tapa y los tornillos nuevamente.

Al finalizar el procedimiento, coloque la etiqueta Dolby suministrada en el panel trasero del equipo para indicar que el módulo ha sido instalado.

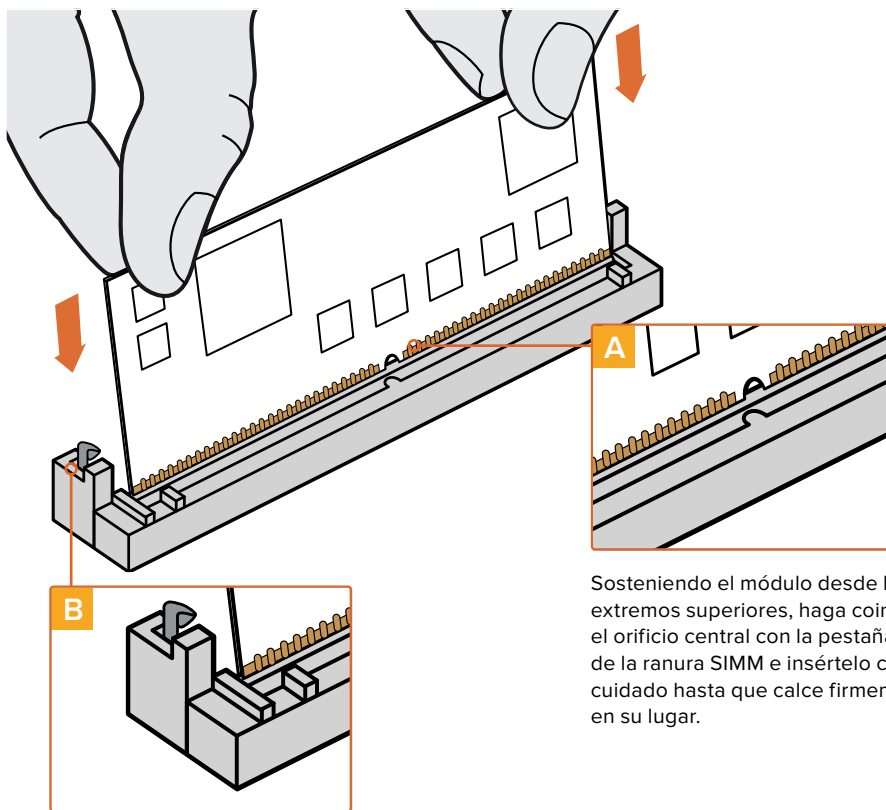

Sosteniendo el módulo desde los extremos superiores, haga coincidir el orificio central con la pestaña de la ranura SIMM e insértelo con cuidado hasta que calce firmemente en su lugar.

Incline el módulo hacia la parte posterior del dispositivo hasta que ambos extremos queden sujetos mediante las trabas metálicas.

Confirmación del sonido Dolby®

Cuando el equipo detecta una señal de audio Dolby codificada, el logotipo correspondiente aparecerá en la esquina superior derecha de la pantalla. Es posible monitorizar cuatro pares de canales de audio envolvente presionando los botones para avanzar o retroceder de canal en el panel de control.

Información para desarrolladores

Control del modelo Blackmagic Audio Monitor 12G mediante Telnet

El protocolo de Ethernet desarrollado por Blackmagic para el dispositivo permite crear soluciones de control personalizadas, tales como aplicaciones o interfaces web, a fin de manejar unidades desde equipos informáticos a través de una red.

En primer lugar, es necesario conectar el dispositivo al equipo informático mediante la red Ethernet. A tales efectos, es posible emplear un cable directo o ajustar su configuración para que forme parte de la misma red.

NOTA: Si el dispositivo está conectado directamente al equipo informático, introduzca una dirección IP estática. Es preciso que los primeros tres grupos de números coincidan con los del dispositivo. Por su parte, la máscara de subred debe ser 255.255.255.0. El campo correspondiente a la puerta de enlace puede dejarse en blanco, ya que no se utilizará si la conexión es directa.

Si la red se ha configurado correctamente, podrá abrir las aplicaciones correspondientes en Mac o Windows para ingresar comandos. La aplicación puede programarse de forma que dichos comandos se activen mediante distintos eventos o a través de una interfaz de usuario personalizada.

Telnet en equipos Mac y Windows

- 1 En equipos Mac, abra la aplicación **Terminal** que se encuentra dentro de la carpeta **Utilidades**.
Para abrir el símbolo del sistema en Windows, haga clic en **Inicio** y escriba «cmd» en el campo de búsqueda. Presione la tecla **Enter**.
- 2 Escriba «telnet», presione la barra espaciadora y añada la dirección IP de su equipo informático. Luego, introduzca otro espacio y escriba «9996», que es el número del puerto preestablecido para el modelo Blackmagic Audio Monitor 12G.

Por ejemplo:

```
telnet 192.168.25.253 9996
```

Presione la tecla **Enter**. Como resultado, aparece la pantalla del preámbulo del protocolo.

Protocolo de Ethernet (versión 1.0)

Resumen

El protocolo está basado en texto, y se accede al mismo desde un dispositivo Blackmagic Audio Monitor 12G, a través del puerto TCP 9996.

El dispositivo envía información en bloques que incluyen un encabezado escrito en mayúsculas, seguido de dos puntos. Cada uno de ellos puede abarcar varias líneas y finaliza con una línea en blanco.

A su vez, cada línea concluye con un carácter que indica el comienzo de otra.

Una vez conectado, el dispositivo transmite un volcado inicial completo con información sobre su estado. Posteriormente, se envían actualizaciones cada vez que ocurre un cambio.

A fin de evitar posibles problemas que pudiesen surgir debido a futuras modificaciones en el protocolo, el cliente deberá ignorar los bloques no reconocidos que figuren antes de la línea en blanco final. Asimismo, es preciso ignorar las líneas que no es posible identificar en cada bloque.

Leyenda

↵ salto de línea o retorno
... Etc.

La versión 1.0 de este protocolo se publicó junto con el programa Blackmagic Audio Monitor 12G 3.0.

Preámbulo

El primer bloque que el dispositivo transmite es el preámbulo del protocolo.

```
PROTOCOL PREAMBLE:  
Version: 1.0
```

El número indica la versión del protocolo. Cuando se efectúan cambios compatibles, el dígito secundario se actualiza. De ser incompatibles, cambia el dígito principal.

Información del dispositivo

El siguiente bloque contiene información sobre el dispositivo conectado. En este caso, se muestran las características del equipo:

```
AUDIOMONITOR DEVICE:↵  
Model: Blackmagic Audio Monitor 12G  
Label: Blackmagic Audio Monitor 12G
```

Solo el nombre puede modificarse.

```
AUDIOMONITOR DEVICE:↵  
Label: My new name↵  
↵
```

La respuesta será la siguiente:

```
ACK:  
AUDIOMONITOR DEVICE:  
Label: My new name
```

El siguiente bloque muestra información sobre los ajustes de configuración, los cuales pueden modificarse desde el programa utilitario del dispositivo cuando está conectado mediante el puerto USB. Solo a modo informativo:

```
NETWORK:  
Dynamic IP: 1  
Current address: 0.0.0.0  
Current subnet: 0.0.0.0  
Current gateway: 0.0.0.0
```

El siguiente bloque corresponde al tipo de vúmetro.

```
AUDIO METER:  
Meter Mode: VU (-20dBFS Ref)
```

Esta información se puede modificar a **VU (-20dBFS Ref)**, **VU (-18dBFS Ref)**, **PPM EBU (-20dBFS Ref)**, **PPM EBU (-18dBFS Ref)**, **PPM BBC (-20dBFS Ref)**, **PPM BBC (-18dBFS Ref)**, **Loudness (EBU +9 scale)** o **Loudness (EBU +18 scale)**.

```
AUDIO METER:↵
Meter Mode: Loudness (EBU +18 scale)↵
↵
```

La respuesta será la siguiente:

```
ACK:
AUDIO METER:
Meter Mode: Loudness (EBU +18 scale)
```

El siguiente bloque corresponde al tipo de fuente.

```
AUDIO INPUT:
Routing: Speaker Stereo SDI Stereo 1-2
```

Esta información se puede modificar a **SDI Stereo 3-4**, **SDI Stereo 5-6**, **SDI Stereo 7-8**, **SDI Stereo 9-10**, **SDI Stereo 11-12**, **SDI Stereo 13-14**, **SDI Stereo 15-16**, **XLR AES/EBU Stereo 1-2**, **XLR Analog Stereo** o **RCA Stereo**.

```
AUDIO INPUT:↵
Routing: Speaker Stereo XLR AES/EBU Stereo 1-2↵
↵
```

La respuesta será la siguiente:

```
ACK:
AUDIO INPUT:
Routing: Speaker Stereo XLR AES/EBU Stereo 1-2
```

El siguiente bloque corresponde al estado de la salida de audio e indica el volumen actual del altavoz y los auriculares, así como el estado de los botones para aislar y silenciar el audio.

```
AUDIO OUTPUT:
Gain: Speaker Stereo 0
Gain: Headphone Stereo 0
Mute: false
Solo: Off
```

Es posible seleccionar un valor entre 0 y 255 para los ajustes de ganancia del volumen. La opción **Mute** puede ser **true** o **false**, mientras que **Solo** puede ser **Off**, **Left** o **Right**.

```
AUDIO OUTPUT:↵
Gain: Speaker Stereo 125↵
Solo: Right↵
↵
```

La respuesta será la siguiente:

```
ACK:
AUDIO OUTPUT:
Gain: Speaker Stereo 125
Solo: Right
```

Verificación de la conexión

Una vez que se establece una conexión con el dispositivo, es posible enviar un comando especial de no operación para comprobar si este aún responde.

```
PING:↵  
↵
```

En caso afirmativo, responderá **ACK** al igual que con cualquier otro comando reconocido.

Verificación de comandos de protocolo válidos

Una vez que se establece una conexión con el dispositivo, es posible enviar un comando especial de ayuda para obtener una lista de comandos Telnet compatibles:

```
HELP:↵  
↵  
AUDIOMONITOR DEVICE:  
Model: <label> [read only]  
Label: <label>  
Unique ID: <label> [read only]  
  
NETWORK:  
Dynamic IP: <boolean> [read only]  
Current address: <IP_address> [read only]  
Current subnet: <IP_address> [read only]  
Current gateway: <IP_address> [read only]  
  
AUDIO METER:  
Meter Mode: <enum> -> <enum> = <"VU (-20dBFS Ref)" | "VU (-18dBFS Ref)" |  
"PPM EBU (-20dBFS Ref)" | "PPM EBU (-18dBFS Ref)" | "PPM BBC (-20dBFS Ref)"  
| "PPM BBC (-18dBFS Ref)" | "Loudness (EBU +9 scale)" | "Loudness (EBU  
+18 scale)">;  
  
AUDIO INPUT:  
Routing: <enum1> <enum2> -> <enum1> = <"Speaker Stereo">; <enum2> = <"SDI  
Stereo 1-2" | "SDI Stereo 3-4" | "SDI Stereo 5-6" | "SDI Stereo 7-8" | "SDI  
Stereo 9-10" | "SDI Stereo 11-12" | "SDI Stereo 13-14" | "SDI Stereo 15-16" |  
"XLR AES/EBU Stereo 1-2" | "XLR Analog Stereo" | "RCA Stereo">;  
  
AUDIO OUTPUT:  
Gain: <enum> <integer> -> <enum> = <"Speaker Stereo" | "Headphone Stereo">;  
<integer> = <0..255>;  
  
Mute: <boolean> -> <boolean> = <true | false>;  
  
Solo: <enum> -> <enum> = <"Off" | "Left" | "Right">;
```

Ayuda

Cómo obtener ayuda

La forma más rápida de obtener ayuda es visitando las páginas de soporte técnico en el sitio web de Blackmagic Design, donde es posible acceder al material de apoyo más reciente.

Página de soporte técnico de Blackmagic Design

Las versiones más recientes del manual, el software del equipo y el material de apoyo se encuentran disponibles en nuestra página de soporte técnico.

Foro de Blackmagic Design

Este foro permite compartir ideas creativas y constituye un recurso útil para obtener más información sobre nuestros productos. Allí también es posible encontrar rápidamente respuestas de usuarios experimentados o suministradas por el personal de Blackmagic Design. Para acceder al foro, visite la página <http://forum.blackmagicdesign.com>.

Cómo ponerse en contacto con nuestro equipo de soporte técnico

Si no encuentra la ayuda que necesita, solicite asistencia técnica mediante el botón **Enviar correo electrónico** situado en la parte inferior de la página de soporte en nuestro sitio web. De forma alternativa, haga clic en el botón **Soporte técnico local** para acceder al número telefónico del centro de atención más cercano.

Cómo comprobar la versión del software instalada

Siga los pasos descritos a continuación para verificar la versión del programa Blackmagic Audio Monitor Setup instalada en su equipo informático.

- En macOS, ejecute el programa desde la carpeta de aplicaciones. Seleccione **About Blackmagic Audio Monitor Setup** en el menú de la aplicación para ver el número de la versión.
- En Windows 10, abra el programa desde la página de inicio. Haga clic en el menú **Ayuda** y seleccione la opción **About Blackmagic Audio Monitor Setup** para ver el número de versión.

Cómo obtener las actualizaciones más recientes

Después de verificar la versión del programa instalada, visite nuestra página de soporte técnico para comprobar si hay actualizaciones disponibles. Aunque generalmente es recomendable instalar las últimas actualizaciones, evite realizar modificaciones al sistema operativo interno si se encuentra en medio de un proyecto importante.

Normativas

Desecho de equipos eléctricos y electrónicos en la Unión Europea:



Este símbolo indica que el dispositivo no debe desecharse junto con otros residuos domésticos. A tales efectos, es preciso llevarlo a un centro de recolección para su posterior reciclaje. Esto ayuda a preservar los recursos naturales y garantiza que dicho procedimiento se realice protegiendo la salud y el medioambiente. Para obtener más información al respecto, comuníquese con el distribuidor o el centro de reciclaje más cercano.



Según las pruebas realizadas, este equipo cumple con los límites indicados para dispositivos digitales Clase A, en conformidad con la sección 15 de las normas establecidas por la Comisión Federal de Comunicaciones. Esto permite proporcionar una protección razonable contra interferencias nocivas al operar el dispositivo en un entorno comercial. Este equipo usa, genera y puede irradiar energía de radiofrecuencia, y si no se instala o utiliza de acuerdo con el manual de instrucciones, podría ocasionar interferencias nocivas para las comunicaciones radiales. El funcionamiento de este equipo en una zona residencial podría ocasionar interferencias nocivas, en cuyo caso el usuario deberá solucionar dicho inconveniente por cuenta propia.

El funcionamiento de este equipo está sujeto a las siguientes condiciones:

- 1 El dispositivo no debe causar interferencias nocivas.
- 2 El dispositivo debe admitir cualquier interferencia recibida, incluidas aquellas que puedan provocar un funcionamiento incorrecto del mismo.

Declaración ISED (Canadá)

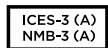

Esta cámara cumple con los estándares canadienses para dispositivos digitales Clase A.

Cualquier modificación o uso indebido del mismo podría acarrear un incumplimiento de dichas normas.

Las conexiones a interfaces HDMI deberán realizarse mediante cables blindados.

Este equipo cumple con las normas descritas anteriormente al emplearse en entornos comerciales. Nótese que podría ocasionar interferencia radial al utilizarlo en ambientes domésticos.

Seguridad

Para evitar el riesgo de descarga eléctrica, este equipo debe enchufarse a una toma de corriente que disponga de un cable a tierra. Ante cualquier duda, póngase en contacto con un electricista capacitado.

A fin de reducir el riesgo de descarga eléctrica, evite exponer el equipo a goteras o salpicaduras.

Este equipo puede utilizarse en climas tropicales, a una temperatura ambiente máxima de 40 °C.

Compruebe que haya suficiente ventilación en torno a la unidad.

Al instalar el equipo en un bastidor, verifique que el dispositivo contiguo no impida la ventilación.

La reparación de los componentes internos del equipo no debe ser llevada a cabo por el usuario. Comuníquese con nuestro centro de atención más cercano para obtener información al respecto.



Evite utilizar el equipo a una altura mayor de 2000 metros.

Declaración del Estado de California

Las partes plásticas de este producto pueden contener trazas de compuestos químicos, tales como polibromobifenilos (PBB), que el Estado de California reconoce como causantes de cáncer, anomalías congénitas o daños reproductivos.

Consulte el sitio www.P65Warnings.ca.gov para obtener más información al respecto.

Garantía

12 meses de garantía limitada

Blackmagic Design garantiza que el producto adquirido no presentará defectos en los materiales o en su fabricación por un período de 12 meses a partir de la fecha de compra. Si un producto resulta defectuoso durante el período de validez de la garantía, Blackmagic Design podrá optar por reemplazarlo o repararlo sin cargo alguno por concepto de piezas y/o mano de obra.

Para acceder al servicio proporcionado bajo los términos de esta garantía, el Cliente deberá dar aviso del defecto a Blackmagic Design antes de su vencimiento y encargarse de los arreglos necesarios para la prestación del mismo. El Cliente será responsable por el empaque y el envío del producto defectuoso al centro de servicio técnico designado por Blackmagic Design y deberá abonar las tarifas postales por adelantado. El Cliente será responsable de todos los gastos de envío, seguros, aranceles, impuestos y cualquier otro importe que surja con relación a la devolución de productos por cualquier motivo.

Esta garantía carecerá de validez ante defectos o daños causados por un uso indebido o por falta de cuidado y mantenimiento. Blackmagic Design no tendrá obligación alguna de prestar el servicio estipulado en esta garantía para (a) reparar daños provocados por intentos de personal ajeno a Blackmagic Design de instalar, reparar o realizar un mantenimiento del producto; (b) reparar daños resultantes del uso de equipos incompatibles o conexiones a los mismos; (c) reparar cualquier daño o mal funcionamiento provocado por el uso de piezas o repuestos no suministrados por Blackmagic Design; o (d) brindar servicio técnico a un producto que haya sido modificado o integrado con otros productos, cuando dicha modificación o integración tenga como resultado un aumento de la dificultad o el tiempo necesario para reparar el producto. ESTA GARANTÍA OFRECIDA POR BLACKMAGIC DESIGN REEMPLAZA CUALQUIER OTRA GARANTÍA, EXPRESA O IMPLÍCITA. POR MEDIO DE LA PRESENTE, BLACKMAGIC DESIGN Y SUS DISTRIBUIDORES RECHAZAN CUALQUIER GARANTÍA IMPLÍCITA DE COMERCIALIZACIÓN O IDONEIDAD PARA UN PROPÓSITO PARTICULAR. LA RESPONSABILIDAD DE BLACKMAGIC DESIGN EN CUANTO A LA REPARACIÓN O SUSTITUCIÓN DE PRODUCTOS DEFECTUOSOS CONSTITUYE UNA COMPENSACIÓN COMPLETA Y EXCLUSIVA PROPORCIONADA AL CLIENTE POR CUALQUIER DAÑO INDIRECTO, ESPECIAL, FORTUITO O EMERGENTE, AL MARGEN DE QUE BLACKMAGIC DESIGN O SUS DISTRIBUIDORES HAYAN SIDO ADVERTIDOS CON ANTERIORIDAD SOBRE LA POSIBILIDAD DE TALES DAÑOS. BLACKMAGIC DESIGN NO SE HACE RESPONSABLE POR EL USO ILEGAL DE EQUIPOS POR PARTE DEL CLIENTE. BLACKMAGIC DESIGN NO SE HACE RESPONSABLE POR DAÑOS CAUSADOS POR EL USO DE ESTE PRODUCTO. EL USUARIO UTILIZA EL PRODUCTO BAJO SU PROPIA RESPONSABILIDAD.

© Copyright 2020 Blackmagic Design. Todos los derechos reservados. Blackmagic Design, DeckLink, HDLink, Workgroup Videohub, Multibrige Pro, Multibrige Extreme, Intensity y *Leading the creative video revolution* son marcas registradas en Estados Unidos y otros países. Todos los demás nombres de compañías y productos pueden ser marcas comerciales de las respectivas empresas a las que estén asociadas.



安装操作手册

Blackmagic Audio Monitor 12G

2020年1月

中文



欢迎辞

感谢您购买和使用Blackmagic Audio Monitor!

我们的梦想是希望人人都能拥有最优质的视频设备，从而使广电行业成为真正充满创意的行业。

无论是广电、后期制作或现场制作，音频监测对于任何视频制作工作流程都至关重要。Blackmagic Audio Monitor以紧凑的机架式设计，为您带来专业音频监测器的所有功能。它可以连接几乎所有音频设备并获得高质量技监，获得高品质监听。Blackmagic Audio Monitor原始机型支持6G-SDI，可连接高达每秒30帧的Ultra HD视频。Blackmagic Audio Monitor 12G支持12G-SDI，可连接高达每秒60帧的Ultra HD视频，并且支持A级和B级3G-SDI视频信号输入。

本操作手册包含使用Blackmagic Audio Monitor所需之全部信息。

请登陆我公司网站www.blackmagicdesign.com/cn的支持页面获得Blackmagic Audio Monitor的最新版操作手册及其各项内部软件更新。同时，请注意定时更新内部软件以便获得最新功能。下载软件时，请注册您的相关信息，以便我们发布新软件时能及时通知您。我们不断致力于产品的功能开发和改进，因此我们热忱期待您的意见和建议!

A handwritten signature in black ink that reads "Grant Petty". The signature is written in a cursive, flowing style.

Grant Petty

Blackmagic Design首席执行官

目录

Blackmagic Audio Monitor 12G

入门	115
Blackmagic Audio Monitor简介	115
连接音频	115
选择音频源	116
连接视频输出	116
使用Blackmagic Audio Monitor	117
使用控制面板	117
LCD	117
音频电平表	117
单放左声道和单放右声道	118
上调音频通道和下调音频通道	118
输入	119
静音	119
音量	119
Audio Monitor Setup软件	120
Blackmagic Audio Monitor Setup软件	120
在macOS系统下安装	120
在Windows系统下安装	120
更新内部软件	120
音频表选项卡	121
配置选项卡	123
更改网络设置	123
通过USB更改网络设置	123
安装Blackmagic Dolby®解码模块（选购）	124
安装模块	124
确认Dolby音频	125
Developer Information	126
帮助	130
监管告知	131
安全信息	132
保修	133

入门

Blackmagic Audio Monitor简介

Blackmagic Audio Monitor和Blackmagic Audio Monitor 12G有着仅1RU的小巧机身, 它可广泛用于各类视频和音频源的现场制作、后期制作以及广播等工作环境中, 是实时音频监测的完美解决方案。

Blackmagic Audio Monitor可连接SD/HD/3G/6G-SDI、数字AES/EBU以及模拟音频设备, 可确保输出正确的音频电平。12G机型支持12G-SDI, 可连接高达每秒60帧的Ultra HD视频。通过左右声道LED音频表可监看音频峰值位置, 而内置LCD屏幕则可显示SDI视频输入以及输入接口类型、视频格式、帧率、音频通道以及音量等重要信息。

您可以监测多达16路SDI嵌入音频, 或使用XLR接口用于平衡模拟音频以及AES/EBU数字音频。此外, 其RCA接口还可以连接到各类消费级设备, 如HiFi系统和iPod等。

Blackmagic Audio Monitor配备两个高质量内部全频域扬声器和两个低音炮, 音域宽广, 高音清脆, 低音浑厚。在嘈杂的环境中, 您可以使用耳机进行更精准的音频监听!



Blackmagic Audio Monitor 12G的前面板



Blackmagic Audio Monitor 12G的后面板

连接音频

Blackmagic Audio Monitor几乎支持所有音频设备! 如果想以SD、HD、2K甚至Ultra HD连接到SDI信号, 只需使用标准BNC接头连接SDI输入即可。12G机型支持A级和B级3G-SDI视频信号输入。

如果想从磁盘录机、数字音频控制台或从调音台及Betacam SP录机等模拟设备监听AES/EBU数字音频, 则选择XLR接头连接。来自VCR和DVD播放器等消费级模拟音频设备可使用标准RCA接口连接。您还能使用1/4英寸TRS耳机插口对音频进行个人监听以防干扰他人。

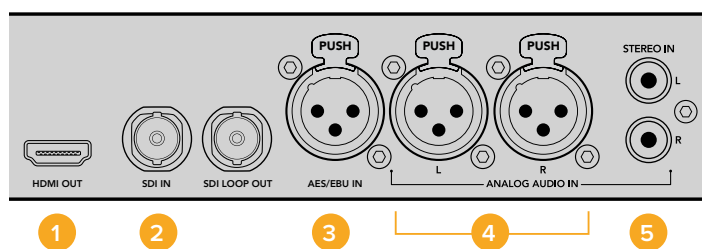

1. HDMI
2. SDI内嵌音频
3. 用于AES/EBU的XLR接口
4. 用于模拟音频的XLR接口
5. 用于连接消费级音频的RCA接口

选择音频源

将音频设备连接到Blackmagic Audio Monitor之后, 只需按控制面板上的“INPUT” (输入) 按钮即可选择连接。选定输入信号并成功连接音频后, 即可观察到LED音频表开始工作。音频表由两排明亮的彩色LED指示灯组成, 可帮助您快速确认音频输入状态。

按下“输入” (INPUT) 按钮便可逐个选择音频连接, 而彩色LCD屏幕则会显示输入类型、音频通道和音量等信息。只要掌握了这些信息, 您就可以使用Blackmagic Audio Monitor进行音频技监了!

连接视频输出

如果需要同时进行视频和音频监测, Blackmagic Audio Monitor可将视频输出到大屏幕或连接到其他视频设备以便您进行视音频监测。

您可使用HDMI和SDI环通输出来监测视频以及内嵌音频。只需单根SDI线缆便可将连接如DeckLink 4K Extreme等SD、HD、2K甚至Ultra HD采集设备。还可通过SD/HD-SDI接口将内嵌音频的视频连接到HyperDeck Studio等录机, 或者通过HDMI接口连接最新Ultra HD显示器及投影仪。

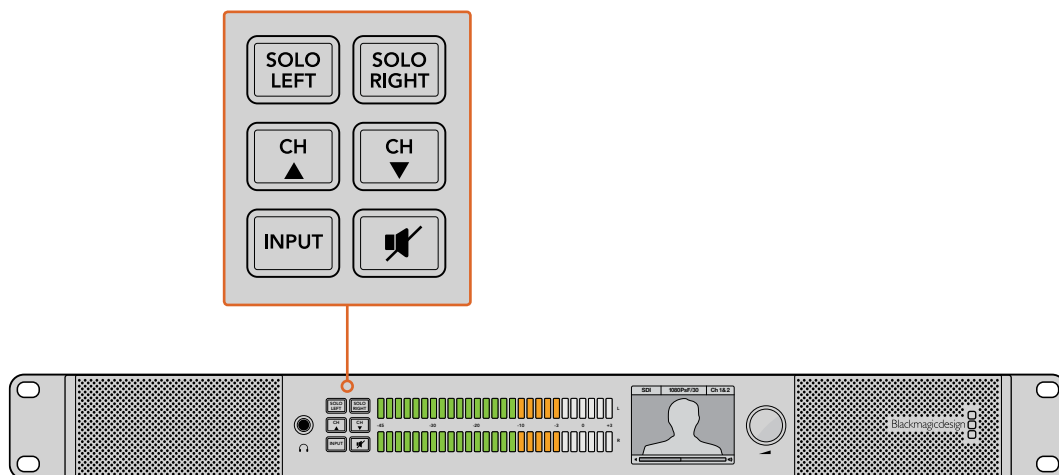

您可通过不同按钮选定您想监测的输入类型, 如分离左右立体声道、音频通道上调和下调以及扬声器或耳机静音功能等。

使用Blackmagic Audio Monitor

使用控制面板

Blackmagic Audio Monitor的控制面板简单易用,可快速选定主要功能和状态。

LCD

设备内置的彩色LCD屏幕有文本重叠功能,连接SDI接口时可显示您所选定的输入信号及视频格式等重要状态信息,还能帮助您选择音频通道、扬声器及耳机音量等。这款LCD屏幕还会显示输入的SDI视频信号。如果未检测到SDI视频,设备会显示一个音乐图标。

每个选定输入所显示的信息如下:

SDI输入

SDI、视频格式、所选音频通道。

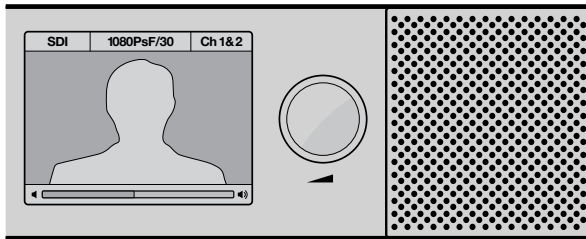

彩色LCD屏幕会显示视频和音频信息,包括连接方式、视频格式、选定音频通道以及音量等。

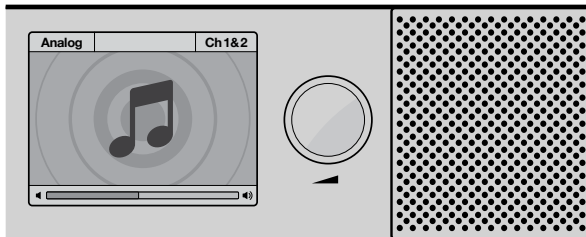

在没有监看SDI视频信号时,通常LCD屏幕上会始终显示音乐图标。

平衡AES/EBU XLR输入

AES/EBU、所选音频通道。

平衡XLR模拟输入

模拟,所选音频通道。

非平衡RCA模拟输入

HiFi,所选音频通道。

音频电平表

Blackmagic Audio Monitor的音频电平表设有两排绿橙红LED指示灯,不同色彩分别代表不同的音频电平强度。如果所有LED指示灯都亮起,则表示您的音频电平过高并存在削波现象。

您在Audio Monitor Setup实用程序中选择的音频表类型设置不同, 音频电平表给出的反馈也有所不同。如果您使用的是VU表技监, 请调整相应音频设备上的输出电平, 使得音频达到峰值时, 控制面板上的指示灯对准0dB刻度处。此操作可达到最高信噪比, 确保最佳音频质量。如果音频峰值超过0dB刻度, 则很有可能导致声音失真。

请参考“Audio Monitor Setup软件”章节获取安装Blackmagic Audio Monitor Setup实用程序以及设置电平表类型的具体操作细节。

单放左声道和单放右声道

这两个按钮可以分离左右声道, 这样您就可以对每个声道进行单独监听, 以便找到问题。

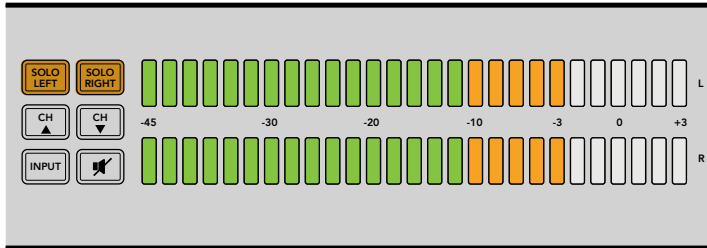

选择SOLO LEFT (单放左声道) 按钮可停止播放右声道。
音频电平表仍可继续显示两个声道的电平。

监听左声道音频:

- 1 按下“SOLO LEFT” (单放左声道) 按钮。此时按钮的绿色背光将会亮起, 扬声器开始单独播放左声道音频。
- 2 再次按下“SOLO LEFT” (单放左声道) 按钮回到立体声音频监听。

监听右声道音频:

- 1 按下“SOLO RIGHT” (单放右声道) 按钮。此时按钮的绿色背光将会亮起, 扬声器开始单独播放右声道音频。
- 2 再次按下“SOLO RIGHT” (单放右声道) 按钮回到立体声音频监听。

上调音频通道和下调音频通道

您可通过这两个按钮对内嵌在SDI接口的音频通道进行逐个查看。对于3G-SDI, 这包含最多16个通道, 即8对。按下通道“上”和“下”按钮, 在SDI内嵌音频通道之间上下移动。

Blackmagic Audio Monitor 12G支持12G-SDI, 包含最多64个音频通道, 即32对通道。按住向上箭头或向下箭头按钮可快速在通道间滚动。

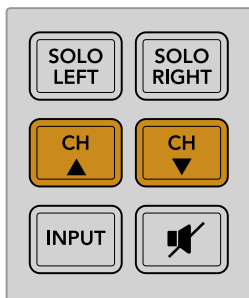

输入

重复按“INPUT”（输入）按钮可逐个扫描并查看SDI、AES/EBU、模拟以及HiFi输入，以便您选择想要监测的视音频设备。

选定的音频输入可通过内置扬声器进行监听，您也可以在HDMI输出的CH 1和2上监测音频。

备注 当选择模拟、AES/EBU或HiFi输入时，HDMI输出将显示黑场视频。SDI环通输出总是输出与SDI输入连接的视频和音频。

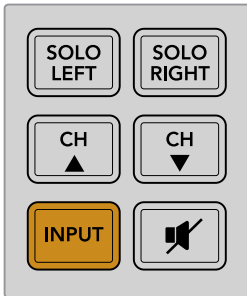

静音

这一按钮可使Blackmagic Audio Monitor控制面板上的扬声器以及耳机静音。静音效果不会影响音频输入，只会影响扬声器和耳机输出。再次按下静音图标按钮便可取消控制面板扬声器和耳机的静音。另外，通过按增加音量按钮也可恢复音频。

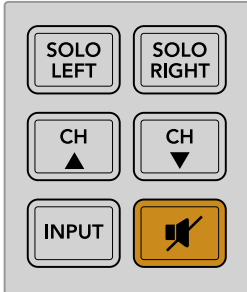

音量

这一旋钮可单独调节扬声器和耳机音量。音量会显示在内置LCD屏幕上。当连接耳机时，Blackmagic Audio Monitor的扬声器会呈静音状态，此时音频通过耳机输出。通过顺时针和逆时针旋转音量旋钮便可轻松调节音量大小。

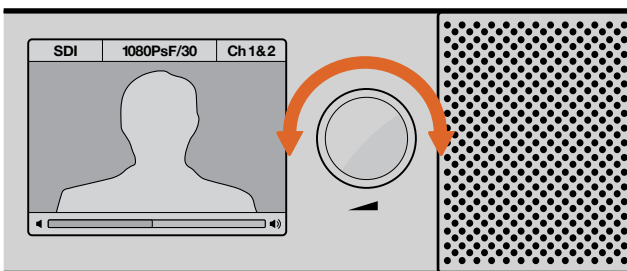

音量显示在控制面板的LCD屏幕上。

Audio Monitor Setup软件

Blackmagic Audio Monitor Setup软件

Blackmagic Audio Monitor Setup实用程序可用于设置您想要的音频电平表类型，并可更新Blackmagic Audio Monitor的内部软件。

本实用程序可使用附赠的SD卡进行安装，但我们建议您从Blackmagic Design支持中心下载最新版本。网址www.blackmagicdesign.com/cn/support。

将Blackmagic Audio Monitor原始机型通过USB与计算机连接后，您可以使用实用程序修改配置设置及更新内部软件。在Blackmagic Audio Monitor 12G上，您还可以通过以太网更新设备和修改设置，但您需要连接USB才可以修改网络设置。

Blackmagic Audio Monitor Setup支持macOS Mojave 10.14或更高版本，以及Windows 10或更高版本。

在macOS系统下安装

- 1 双击内附的安装文件，如果您从Blackmagic Design网站下载该程序，请找到下载文件夹，并双击其中的安装文件。
- 2 根据安装提示操作，macOS会自动安装该软件。

在Windows系统下安装

- 1 双击内附的安装文件，如果您从Blackmagic Design网站下载该程序，请找到下载文件夹，并双击其中的安装文件。
- 2 根据安装提示操作，并同意License Agreement许可协议条款，Windows会自动安装该软件。

更新内部软件

- 1 通过USB或以太网将Blackmagic Audio Monitor连接到您的计算机。
- 2 打开Blackmagic Audio Monitor Setup软件。
- 3 点击配置图标后，实用程序会提示您是否需要更新。
- 4 如果需要更新，请点击“Update”按钮，并完成软件安装。



点击“Update”按钮开始内部软件更新。

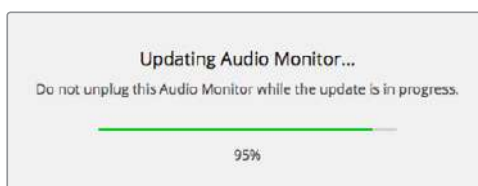

进度条可显示更新状态。

- 5 更新完成后，点击“Close”按钮关闭。



使用Blackmagic Audio Monitor Setup实用软件更新Blackmagic Audio Monitor的内部软件，以及修改配置设置。

音频表选项卡

进入设置实用程序后，点击配置图标打开音频电平表设置项。您可选择VU表、PPM表或响度计等音频表类型以及EBU和BBC等测量标准。如今，VU表已逐渐标准化，PPM表和响度计则可以提供度量系统，或测量感知到的响度。下面这张表列出了设备所支持的音频电平表及其相应的度量组合。

音频表类型	测量标准	测量范围	如何使用
VU表	-	-45到+3	印于设备
PPM表	EBU	-12到+12	贴标
PPM表	BBC	1到7	贴标
响度计	EBU +9	-18到+9	贴标
响度计	EBU +18	-36到+18	贴标
响度计	满刻度 +9	-41到-14	贴标
响度计	满刻度 +18	-59到-5	贴标

VU表

该表可反馈音频信号中峰谷的平均值。它最常用于监测信号中的峰值，但是由于它具备平均值功能，因此也可用于监测音频的感知响度。

PPM表

该表具有“峰值保持”功能，可暂时保留信号峰值，并可缓慢下降还原，以便您明确音频于何处达到峰值。

响度计

该表可显示音频信号响度的主观质量。为了确保音频响度一致，现在的播出标准都包括响度技监。

VU表和PPM表都可以选择-18dB或-20dB两种参考电平，因此您可以按照不同的国际播出标准监测音频。

Blackmagic Audio Monitor的LED指示灯会根据所选的音频表类型相应给出不同反馈供您参考。Blackmagic Audio Monitor提供准确的dB参考刻度贴标，可帮助您明确音频于何处达到峰值。只需揭开贴纸并粘贴到位于两排彩色LED指示灯之间的位置，覆盖当前的VU表刻度即可。

每类音频电平表所对应的测量标准各备有两张刻度贴标。您也可向当地Blackmagic Design办事处获取贴标。请登录www.blackmagicdesign.com/cn/support网站访问Blackmagic Design支持中心寻找您所在地区的支持团队。

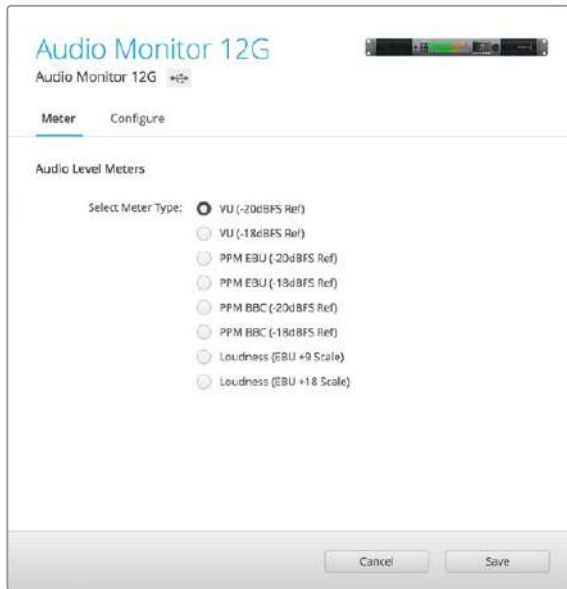

要为您的Blackmagic Audio Monitor选择一类音频表显示，请先选中想要使用的音频表类型，然后点击“Save”（保存）即可。

EBU PPM									
-12	-8	-4	0	+4	+8	+12			
-12	-8	-4	0	+4	+8	+12			
BBC PPM									
1	2	3	4	5	6	7			
1	2	3	4	5	6	7			
Loudness Units EBU +9dB									
-18	-15	-12	-9	-6	-3	0	+3	+6	+9
-18	-15	-12	-9	-6	-3	0	+3	+6	+9
Loudness Units Fullscale +9dB									
-41	-38	-35	-32	-29	-26	-23	-20	-17	-14
-41	-38	-35	-32	-29	-26	-23	-20	-17	-14
Loudness Units EBU +18dB									
-36	-30	-24	-18	-12	-6	0	+6	+12	+18
-36	-30	-24	-18	-12	-6	0	+6	+12	+18
Loudness Units Fullscale +18dB									
-59	-53	-47	-41	-35	-29	-23	-17	-11	-5
-59	-53	-47	-41	-35	-29	-23	-17	-11	-5

产品内附贴标，以便您使用各类音频表时都能准确监看音频峰值位置。

配置选项卡

Blackmagic Audio Monitor 12G额外配有一个“配置”选项卡，其中列出了软件版本，并包含Blackmagic Audio Monitor的网络设置信息。您也可以自定义设备名称。远程连接时，命名设备可以帮助您快速找到设备。

命名您的Blackmagic Audio Monitor 12G

如要命名您的Blackmagic Audio Monitor 12G:

- 1 点击“Configure”选项卡。
- 2 在“Details”设置选项中点击“Name”文本框，输入新的标签。
- 3 点击“Save”。



更改网络设置

通过网络访问Blackmagic Audio Monitor 12G是管理多台设备最简便的方法。您可通过Blackmagic Audio Monitor Setup来实现这一操控。Blackmagic Audio Monitor 12G会默认自动获取网络地址，方便您从实用程序主菜单中快速选择。

如果您无法在网络上找到Blackmagic Audio Monitor 12G，或者之前设置使用的静态地址无匹配当前网络，您可能需要到设备上手动更改其网络设置。您可以通过USB进行操作。

通过USB更改网络设置

如要通过USB修改网络设置，将Blackmagic Audio Monitor 12G用USB线缆连接到运行Blackmagic Audio Monitor Setup使用程序的计算机即可。Blackmagic Audio Monitor 12G的USB接口位于后面板。完成连接后，从Blackmagic Audio Monitor Setup实用软件的主菜单中选择您的Audio Monitor 12G，然后浏览至“Configure”选项卡。您可以利用该选项卡在动态和静态网络地址之间切换。如果您选择了静态IP地址，可以手动配置地址、子网掩码和网关。

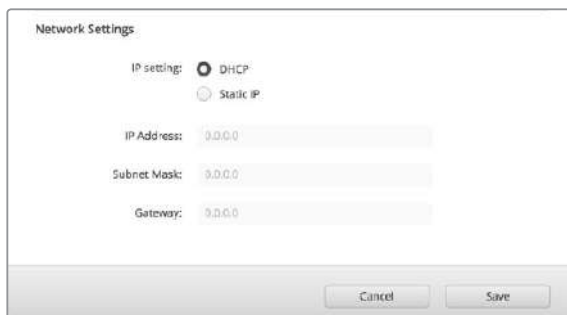

安装Blackmagic Dolby®解码模块 (选购)

杜比公司现已停止生产杜比解码模块, 但是如果您已经购买了Blackmagic Audio Monitor原始版本所用的模块, 并且想要安装, 请参考本页列出的步骤进行操作。

备注 Blackmagic Audio Monitor 12G支持选购杜比解码模块。

警告

安装杜比解码模块前, 请务必切断Blackmagic Audio Monitor的电源, 因为安装时需要打开机身盖使用主板。该流程必须由有资格的专业人士进行操作。同时应做好防护措施, 以降低安装该模块时发生静电漏电现象带来的危险。

安装模块

安装了Blackmagic Dolby解码模块后, 您可以监测现代电影电视制作所使用的Dolby Digital或音频。Dolby 5.1环绕声可对前部左右声道、后部环绕左右声道、中央声道以及一个低音频声道进行编码。

Dolby解码器是72 pin SIMM模块, 可以轻松安装到Blackmagic Audio Monitor主机板上空的SIMM插槽中。

安装Blackmagic Dolby®解码模块步骤如下:

- 1 确保Blackmagic Audio Monitor处于断电状态。
- 2 用十字头螺丝刀旋开Blackmagic Audio Monitor机身罩的全部螺丝 (共21枚), 取下机身罩。
- 3 手持Blackmagic Dolby解码模块, 将接触点朝向空的SIMM插槽。SIMM的键槽必须对准插槽键, 否则无法将SIMM正确插装。
- 4 小心将模块插入SIMM插槽, 直至接触点插紧并固定。
- 5 将模块向Blackmagic Audio Monitor机身后面侧倾斜, 直至模块两边的金属夹扣紧并固定。
- 6 重新安装好Blackmagic Audio Monitor机身罩, 旋紧21枚螺丝。

Blackmagic Dolby解码模块安装完毕后, 将内附的Dolby贴纸粘贴在位于Blackmagic Audio Monitor机身后面板的警示标签边上, 以便确认Dolby模块已安装。

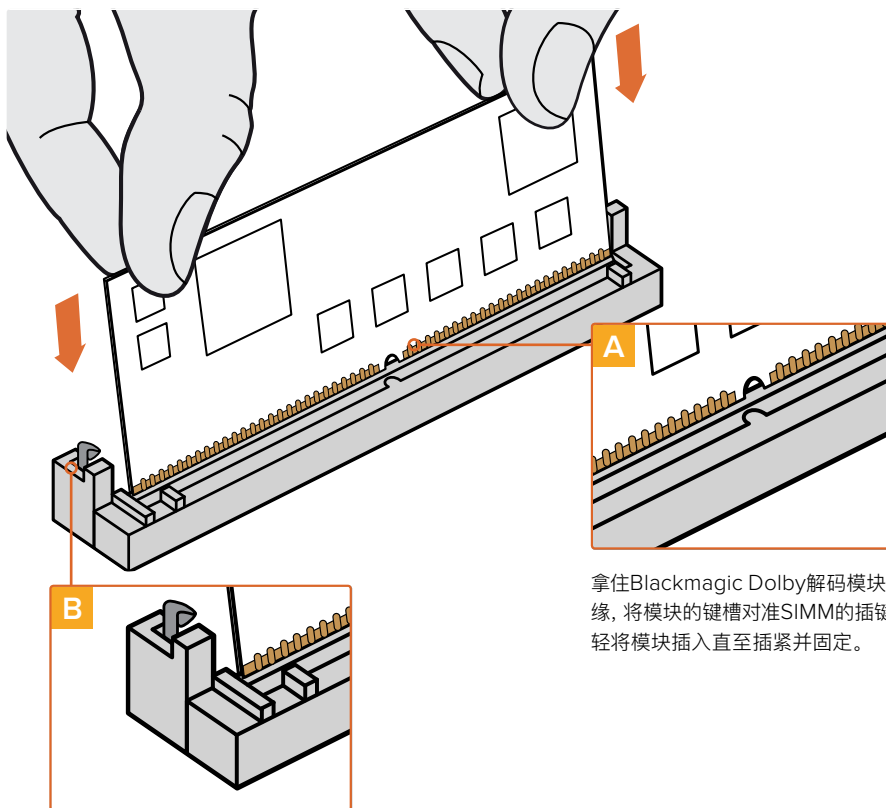

按住Blackmagic Dolby解码模块顶部边缘，将模块的键槽对准SIMM的插键槽，轻轻将模块插入直至插紧并固定。

将Blackmagic Dolby解码模块向Blackmagic Audio Monitor机身右侧倾斜，直至模块两边的金属夹扣紧并固定。

确认Dolby音频

当Blackmagic Audio Monitor检测到Dolby编码音频后，Dolby图标便会显示在控制面板LCD屏幕的右上角。您只要按下控制面板上的上调音频通道和下调音频通道按钮即可以对4组Dolby环绕声道进行监测。

Developer Information

Controlling Blackmagic Audio Monitor 12G using Telnet

The Blackmagic Audio Monitor 12G Ethernet Protocol gives you the freedom to build your own custom control solutions for your Blackmagic Audio Monitor 12G. For example, you can create your own software application or web interface to control your Blackmagic Audio Monitor 12G via Ethernet from your computer.

The first step is to connect your Blackmagic Audio Monitor 12G to your computer via Ethernet. You can do this by connecting to the same network your computer is connected to, or you can connect Blackmagic Audio Monitor 12G directly to your computer.

NOTE If Blackmagic Audio Monitor 12G is connected directly to your computer, set your computer to a manual static IP address. Set the first three blocks of numbers in the IP address to match your Blackmagic Audio Monitor 12G and set the subnet mask to 255.255.255.0. You can leave the gateway or router setting blank as it will not be used in a direct connection between your computer and Blackmagic Audio Monitor 12G.

If your network settings are set correctly, you can now open the Terminal application on macOS, or enable Telnet command line utilities on Windows and enter Blackmagic Audio Monitor 12G Ethernet Protocol commands. These commands can be programmed into your application and triggered by related items on a custom user interface of your own design.

Using Telnet on macOS and Windows

- 1 On macOS, open the Terminal application which is located within the Applications > Utilities folder.

To open the command prompt in Windows, click on the 'start' menu and type 'cmd' in the search bar. Press 'enter'.

- 2 Type in "telnet" and a space followed by the IP address of your computer, then another space and "9996", which is the default port number for Blackmagic Audio Monitor 12G.

For example:

```
telnet 192.168.25.253 9996
```

Press 'enter'. The Protocol Preamble screen will appear.

Blackmagic Audio Monitor 12G Ethernet Protocol V1.0

Summary

The Blackmagic Audio Monitor 12G Ethernet Protocol is a text based protocol that is accessed by connecting to TCP port 9996 on a Blackmagic Audio Monitor 12G.

The Blackmagic Audio Monitor 12G sends information in blocks which each have an identifying header in all-caps, followed by a full-colon. A block spans multiple lines and is terminated by a blank line.

Each line in the protocol is terminated by a new line character.

Upon connection, the Blackmagic Audio Monitor 12G sends a complete dump of the state of the device. After the initial status dump, status updates are sent every time the Blackmagic Audio Monitor 12G status changes.

To be resilient to future protocol changes, clients should ignore blocks they do not recognize, up to the trailing blank line. Within existing blocks, clients should ignore lines they do not recognize.

Legend

↵ line feed or carriage return
... and so on

Version 1.0 of the Blackmagic Audio Monitor 12G Ethernet Protocol was released with Blackmagic Audio Monitor 12G 3.0 software.

Protocol Preamble

The first block sent by the Blackmagic Audio Monitor 12G is always the protocol preamble:

```
PROTOCOL PREAMBLE:  
Version: 1.0
```

The version field indicates the protocol version. When the protocol is changed in a compatible way, the minor version number will be updated. If incompatible changes are made, the major version number will be updated.

Device Information

The next block contains general information about the connected Blackmagic Audio Monitor 12G device. If a device is connected, the Blackmagic Audio Monitor 12G will report the attributes of the Blackmagic Audio Monitor 12G:

```
AUDIOMONITOR DEVICE:↵  
Model: Blackmagic Audio Monitor 12G  
Label: Blackmagic Audio Monitor 12G
```

Only the label can be modified.

```
AUDIOMONITOR DEVICE:↵  
Label: My new name↵  
↵
```

The response will be

```
ACK:  
AUDIOMONITOR DEVICE:  
Label: My new name
```

The next block will show the network settings which can only be changed via the Blackmagic Audio Monitor Setup utility when connected over USB. This is for information only.

```
NETWORK:  
Dynamic IP: 1  
Current address: 0.0.0.0  
Current subnet: 0.0.0.0  
Current gateway: 0.0.0.0
```

The next block is the meter type.

```
AUDIO METER:  
Meter Mode: VU (-20dBFS Ref)
```

This can be changed to VU (-20dBFS Ref), VU (-18dBFS Ref), PPM EBU (-20dBFS Ref), PPM EBU (-18dBFS Ref), PPM BBC (-20dBFS Ref), PPM BBC (-18dBFS Ref), Loudness (EBU +9 scale) or Loudness (EBU +18 scale)

```
AUDIO METER:↵  
Meter Mode: Loudness (EBU +18 scale)↵  
↵
```

The response will be

```
ACK:  
AUDIO METER:  
Meter Mode: Loudness (EBU +18 scale)
```

The next block is the input type.

```
AUDIO INPUT:  
Routing: Speaker Stereo SDI Stereo 1-2
```

This can be changed to SDI Stereo 3-4, SDI Stereo 5-6, SDI Stereo 7-8, SDI Stereo 9-10, SDI Stereo 11-12, SDI Stereo 13-14, SDI Stereo 15-16, XLR AES/EBU Stereo 1-2, XLR Analog Stereo or RCA Stereo

```
AUDIO INPUT:↵  
Routing: Speaker Stereo XLR AES/EBU Stereo 1-2↵  
↵
```

The response will be

```
ACK:  
AUDIO INPUT:  
Routing: Speaker Stereo XLR AES/EBU Stereo 1-2
```

The next block is the audio output state. This indicates the current headphone and speaker volume settings as well as the state of the mute and solo buttons.

```
AUDIO OUTPUT:  
Gain: Speaker Stereo 0  
Gain: Headphone Stereo 0  
Mute: false  
Solo: Off
```

The volume gain settings can be set between 0 and 255. Mute can be true or false and Solo can be Off, Left or Right

```
AUDIO OUTPUT:↵  
Gain: Speaker Stereo 125↵  
Solo: Right↵  
↵
```

The response will be

```
ACK:  
AUDIO OUTPUT:  
Gain: Speaker Stereo 125  
Solo: Right
```

Checking the Connection

While the connection to the Blackmagic Audio Monitor 12G is established, a client may send a special no-operation command to check that the Blackmagic Audio Monitor 12G is still responding:

```
PING:↵  
↵
```

If the Blackmagic Audio Monitor 12G is responding, it will respond with an ACK message as for any other recognized command.

Checking valid Protocol Commands

While the connection to the Blackmagic Audio Monitor 12G is established, a client may send a special HELP command to obtain a list of supported Telnet commands:

```
HELP:↵  
↵  
AUDIOMONITOR DEVICE:  
Model: <label> [read only]  
Label: <label>  
Unique ID: <label> [read only]  
  
NETWORK:  
Dynamic IP: <boolean> [read only]  
Current address: <IP_address> [read only]  
Current subnet: <IP_address> [read only]  
Current gateway: <IP_address> [read only]  
  
AUDIO METER:  
Meter Mode: <enum> -> <enum> = <"VU (-20dBFS Ref)" | "VU (-18dBFS Ref)" |  
"PPM EBU (-20dBFS Ref)" | "PPM EBU (-18dBFS Ref)" | "PPM BBC (-20dBFS Ref)"  
| "PPM BBC (-18dBFS Ref)" | "Loudness (EBU +9 scale)" | "Loudness (EBU +18  
scale)">;  
  
AUDIO INPUT:  
Routing: <enum1> <enum2> -> <enum1> = <"Speaker Stereo">; <enum2> = <"SDI  
Stereo 1-2" | "SDI Stereo 3-4" | "SDI Stereo 5-6" | "SDI Stereo 7-8" | "SDI  
Stereo 9-10" | "SDI Stereo 11-12" | "SDI Stereo 13-14" | "SDI Stereo 15-16" |  
"XLR AES/EBU Stereo 1-2" | "XLR Analog Stereo" | "RCA Stereo">;  
  
AUDIO OUTPUT:  
Gain: <enum> <integer> -> <enum> = <"Speaker Stereo" | "Headphone Stereo">;  
<integer> = <0..255>;  
  
Mute: <boolean> -> <boolean> = <true | false>;  
  
Solo: <enum> -> <enum> = <"Off" | "Left" | "Right">;
```

帮助

获得帮助

获得帮助最快捷的方法是登陆Blackmagic Design在线支持页面, 浏览Blackmagic Audio Monitor的相关最新支持材料。

Blackmagic Design在线支持页面

请登陆Blackmagic Design支持中心www.blackmagicdesign.com/cn/support获得最新版操作手册、软件以及技术答疑文章。

Blackmagic Design论坛

您可以登陆我们的网站访问Blackmagic Design论坛, 获得更多信息和有用的创意资源。访问论坛也是获取帮助的一个捷径, 因为论坛中不乏经验丰富的用户和Blackmagic Design的员工, 他们都能为您答疑解惑。请登陆网址<http://forum.blackmagicdesign.com>进入论坛。

联系Blackmagic Design支持中心

如果我们提供的支持信息和论坛均无法解答您的疑问, 请到支持页面下点击“给我们发送电子邮件”按钮即可发送技术支持请求。或者, 您也可以点击支持页面下的“查找您所在地区的支持团队”按钮, 致电您所在地区Blackmagic Design支持中心获得帮助。

查看当前安装的软件版本

要检查您计算机上所安装的Blackmagic Audio Monitor Setup软件版本, 请打开“About Blackmagic Audio Monitor Setup”窗口查看。

- 在macOS系统下, 请到“应用程序”文件夹中打开Blackmagic Audio Monitor Setup软件, 并到应用程序菜单中选择“About Blackmagic Audio Monitor Setup”即可查看版本号。
- 在Windows 10系统下, 请从开始页面的Blackmagic Audio Monitor Setup板块打开Blackmagic Audio Monitor Setup。点击“Help” (帮助) 菜单并选择“About Blackmagic Audio Monitor Setup”即可查看版本号。

如何获得软件更新

检查完您电脑上安装的Blackmagic Audio Monitor Setup软件版本号之后, 请登录网址www.blackmagicdesign.com/cn/support访问Blackmagic Design支持中心查看最新版本。请及时将软件升级到最新版本, 但切勿在重要项目制作过程中升级软件。

监管告知

在欧盟范围内处置电子垃圾和电子设备的注意事项。



根据产品所附的提示标志，本设备不得与其它废弃材料共同处置。处置废弃设备时，必须交给指定收集点进行回收。对废弃设备进行单独收集并回收能够节省自然资源，且回收方式不会损害环境和人体健康。获取更多关于废弃设备回收点的信息，请联系您所在城市的回收站，或当时购买设备的经销商。



本设备经过测试，符合FCC规则的第15部分对A类数字设备的限制。这些限制旨在为运行于商业环境中的设备提供合理保护，使其免受有害干扰的影响。本设备可生成、使用且辐射射频能量，如果未按照安装手册来安装和使用本设备，则可能导致对无线电通信的有害干扰。在住宅区运行本产品可能会产生有害干扰，在这种情况下将由用户自行承担消除干扰的费用。

必须满足以下条件后方可操作：

- 1 设备不会造成有害干扰。
- 2 设备必须能够承受任何干扰，包括可能导致意外操作的干扰。

加拿大ISED认证声明

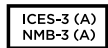

本设备符合加拿大A类数码产品的相关标准。

任何对本产品的改装或预期用途之外的使用均可能导致相关标准认证无效。

必须使用有高品质屏蔽的HDMI电缆连接HDMI接口。

本设备经检测符合商业环境使用要求。在家用环境中，本设备可能会造成无线电干扰。

安全信息

为避免触电, 设备必须连接在配有保护地线的电源插座。如有疑问, 请与具有相关资质的电工进行确认。

为了降低触电风险, 请勿将设备放在会滴水或溅水的地方。

本产品适合在环境温度低于40°C的热带地区使用。

确保设备四周留有足够的空间, 不受阻碍。

安装在机架上时, 确保相邻设备不会影响通风。

设备内部没有操作人员可维护的零件。维修服务请联系当地Blackmagic Design服务中心。



请在海拔高度2000米以下的地区使用。

加利福尼亚安全声明

该产品可能会使您暴露于微量的化学制品之下, 比如塑料部分中含有的多溴化联苯, 该物质已被加利福尼亚州列为可导致癌症、出生缺陷或其他生殖伤害。

详情请访问网址www.P65Warnings.ca.gov。

保修

12个月有限保修

Blackmagic Design保证本产品自购买之日起12个月内不会有材料和工艺上的缺陷。若本产品在本保修期内出现质量问题, Blackmagic Design可选择为产品提供免费修理或更换零部件, 或者更换缺陷产品。

为确保消费者有权享受本保修条款中的服务, 如遇产品质量问题请务必在本保修期内联系Blackmagic Design并妥善安排保修事宜。消费者应将缺陷产品包装并运送到Blackmagic Design的指定服务中心进行维修, 运费由消费者承担并预先支付。若消费者因任何原因退货, 所有运费、保险费、关税等各项税务以及其他费用均由消费者承担。

本保修条款不适用于任何因使用、维护不当或保养不周造成的缺陷、故障或损坏。根据本保修服务, Blackmagic Design的保修服务范围不包括以下内容: 1. 对由非Blackmagic Design专门人员进行的安装、维修或保养所造成的损坏进行维修, 2. 对因使用不当或连接到不兼容设备所造成的损坏进行维修, 3. 对因使用了非Blackmagic Design生产的零部件所导致的损坏或故障进行维修, 及 4. 对经过改装或其他产品进行组装的产品进行保养维修(因为产品经改装或组装后会增加保养维修所需时间或保养难度)。本保修条款由BLACKMAGIC DESIGN提供, 它可取代所有其他明示或隐含的保修。BLACKMAGIC DESIGN及其供应商对任何有关适销性及就特定用途的适用性等隐含保证不作任何担保。BLACKMAGIC DESIGN负责为消费者提供缺陷产品的维修或更换服务是完整和排他性补救措施, 不论BLACKMAGIC DESIGN或其供应商是否事先获悉发生间接、特殊、偶然或必然损坏等损坏的可能性。若消费者对本设备进行非法使用, BLACKMAGIC DESIGN概不负责。对因使用本产品造成的损失, BLACKMAGIC DESIGN概不负责。本产品的操作风险由用户自行承担。

© 版权所有 2020 Blackmagic Design。保留一切权利。“Blackmagic Design”、“DeckLink”、“HDLINK”、“Workgroup Videohub”、“Multibridge Pro”、“Multibridge Extreme”、“Intensity”以及“Leading the creative video revolution”均为美国及其他国家的注册商标。所有其他公司名称及产品名称可能是其他所有者的注册商标。



설치 및 사용 설명서

Blackmagic Audio Monitor 12G

2020년 1월

한국어



환영합니다.

여러분의 프로덕션 작업을 위해 Blackmagic Audio Monitor를 구입해 주셔서 감사합니다.

모두가 고화질의 비디오 장비를 사용할 수 있도록 하여 TV 산업을 진정한 창조 산업으로 발전시켜 나가려는 저희의 목표를 함께 이뤄갈 수 있기를 희망합니다.

오디오 모니터링은 방송/후반 제작/라이브 제작 같은 비디오 제작 워크플로에서 매우 중요한 작업입니다. Blackmagic Audio Monitor는 전문가용 오디오 모니터에서 제공하는 모든 기능을 소형 랙마운트 디자인에 담은 제품입니다. 사실상 거의 모든 종류의 오디오 장비에 연결하여 고화질 모니터링을 수행할 수 있습니다. 기존 Blackmagic Audio Monitor 모델은 최대 30fps의 UHD 영상을 연결할 수 있는 6G-SDI를 지원합니다. Blackmagic AudioMonitor 12G는 최대 60fps의 UHD 영상을 연결할 수 있는 12G-SDI를 지원하며 레벨 A와 레벨 B의 3G-SDI 영상 신호 입력을 또한 지원합니다.

본 설명서에는 Blackmagic Audio Monitor 사용에 필요한 모든 정보가 담겨있습니다.

자사의 웹사이트 www.blackmagicdesign.com/kr 고객지원 페이지에서 최신 버전의 Blackmagic Audio Monitor 설명서와 소프트웨어 업데이트를 확인하실 수 있습니다. 최신 버전의 내부 소프트웨어 업데이트를 통해 항상 새로운 기능을 이용하실 수 있습니다. 소프트웨어를 다운로드할 때 사용자 정보를 등록하시면 새로운 소프트웨어가 출시될 때마다 업데이트 소식을 받아보실 수 있습니다. 저희는 새로운 기능과 제품 향상을 위해서 끊임없이 노력하고 있으며, 항상 고객 여러분의 의견을 기다립니다!

Blackmagic Design의 CEO 그랜트 패티

목차

Blackmagic Audio Monitor 12G

시작하기	137
Blackmagic Audio Monitor 소개	137
오디오 연결하기	137
오디오 소스 선택하기	138
비디오 출력과 연결하기	138
Blackmagic Audio Monitor 사용하기	139
제어 패널 사용하기	139
LCD	139
오디오 레벨 미터	139
SOLO LEFT 및 SOLO RIGHT 버튼	140
채널 업 및 채널 다운 버튼	140
입력(Input) 버튼	141
음소거 버튼	141
볼륨	141
Audio Monitor Setup	142
Blackmagic Audio Monitor Setup	142
macOS에 설치하기	142
Windows에 설치하기	142
내부 소프트웨어 업데이트하기	142
Meter 탭	143
Configure 탭	145
네트워크 설정 변경하기	145
USB를 통해 네트워크 설정 변경하기	145
Blackmagic Dolby® Decoder Module 옵션 설치하기	146
모듈 설치하기	146
Dolby 오디오 확인하기	147
Developer Information	148
Controlling Blackmagic Audio Monitor 12G using Telnet	148
Blackmagic Audio Monitor 12G Ethernet Protocol V1.0	148
지원	152
규제 사항	153
안전 정보	154
보증	155

시작하기

Blackmagic Audio Monitor 소개

Blackmagic Audio Monitor와 Blackmagic Audio Monitor 12G는 다양한 비디오 및 오디오 소스를 라이브/후반 제작/방송 환경에서 사용 가능한 1RU 크기의 실시간 오디오 모니터링 솔루션입니다.

Blackmagic Audio Monitor를 SD/HD/3G/6G-SDI 및 디지털 AES/EBU, 아날로그 오디오 장비에 연결하여 올바른 오디오 레벨을 출력하는지 확인할 수 있습니다. 12G 모델은 12G-SDI를 지원하여 최대 60fps의 UHD를 연결할 수 있습니다. 좌/우 채널의 LED 레벨 미터를 통해 오디오가 피킹되는 지점을 확인할 수 있으며, 내장 LCD를 통해 SDI 비디오 입력뿐만 아니라 연결 유형, 비디오 포맷, 프레임 속도, 오디오 채널, 볼륨 크기 등의 중요한 정보가 표시됩니다.

최대 16채널의 임베디드 SDI 오디오를 모니터링 하거나 균형 아날로그 및 AES/EBU 디지털 오디오를 위해 XLR 커넥터를 사용할 수 있습니다. RCA 커넥터 또한 탑재되어 있어 HiFi 시스템과 iPod 등의 일반 소비자용 장비를 연결할 수 있습니다.

Blackmagic Audio Monitor는 2개의 풀레인지 스피커와 2개의 서브우퍼를 탑재해 깨끗하고 깊은 음향 재생을 위한 광범위한 주파수를 제공합니다. 또한 소란스러운 환경에서 작업할 경우에는 헤드셋을 연결해 정확한 음향을 모니터링할 수도 있습니다!

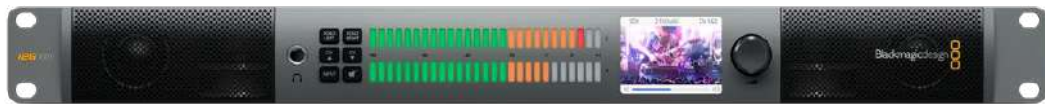

Blackmagic Audio Monitor 12G 전면 패널의 모습



Blackmagic Audio Monitor 12G 뒷면 패널의 모습

오디오 연결하기

Blackmagic Audio Monitor는 거의 모든 종류의 오디오 장비를 지원합니다! SD/HD/2K/UHD의 SDI 신호를 연결하려면 표준 BNC 커넥터를 사용하여 SDI 입력을 통해 연결할 수 있습니다. 12G 모델은 레벨 A와 레벨 B 3G-SDI 비디오 신호 입력을 지원합니다.

디스크 리코더와 디지털 오디오 콘솔 등의 디지털 AES/EBU 오디오나 오디오 믹서 및 Betacam SP 데크 등의 아날로그 장비 오디오를 모니터링할 경우 XLR 커넥터를 사용해 연결하세요. 표준 RCA 커넥터를 사용해 VCR 및 DVD 플레이어 등 일반 소비자용 장비의 아날로그 오디오를 연결할 수 있습니다. 1/4인치 TRS 헤드폰 잭에 헤드폰을 연결하여 다른 사람들에게 피해를 주지 않고 오디오를 들을 수 있습니다.

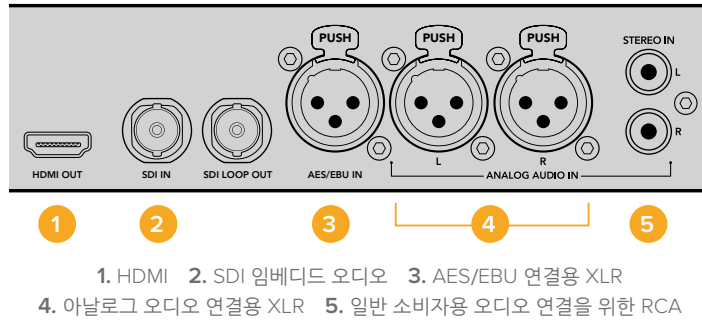

오디오 소스 선택하기

오디오 장비를 Blackmagic Audio Monitor에 연결한 뒤, 제어 패널에 있는 INPUT 버튼을 눌러 연결을 선택하기만 하면 됩니다. 입력이 선택되어 오디오 사용 준비가 완료되면 오디오 레벨 미터 LED에 불이 들어옵니다. 오디오 미터 레벨은 2줄의 컬러 LED로 구성되어 있으며, 불이 밝게 들어와 오디오 입력이 작동 중인지 쉽게 확인할 수 있습니다.

INPUT 버튼을 사용해 오디오 연결을 전환할 수 있으며, 컬러 LCD에서 입력 유형과 오디오 채널, 볼륨 레벨 등의 정보와 함께 연결된 오디오를 확인할 수 있습니다. Blackmagic Audio Monitor를 사용하여 오디오를 모니터링하는 데 필요한 모든 준비가 완료되었습니다.

비디오 출력과 연결하기

오디오뿐만 아니라 비디오도 모니터링해야 하는 경우, Blackmagic Audio Monitor의 비디오 출력을 통해 대형 스크린에서 오디오와 함께 영상을 모니터링하거나 다양한 비디오 장비에 연결할 수 있습니다.

HDMI 출력과 6G-SDI 루프 출력을 사용해 비디오와 임베디드 오디오를 모니터링할 수 있습니다. 하나의 SDI 케이블을 통해 SD와 HD, 2K뿐만 아니라 DeckLink 4K Extreme과 같은 UHD 캡처 장비에도 연결할 수 있습니다. SD/HD-SDI를 통해 비디오와 임베디드 오디오를 HyperDeck Studio 등의 녹화 데크에 연결하거나 HDMI를 통해 최신 UHD 디스플레이 및 프로젝트에 연결하세요.

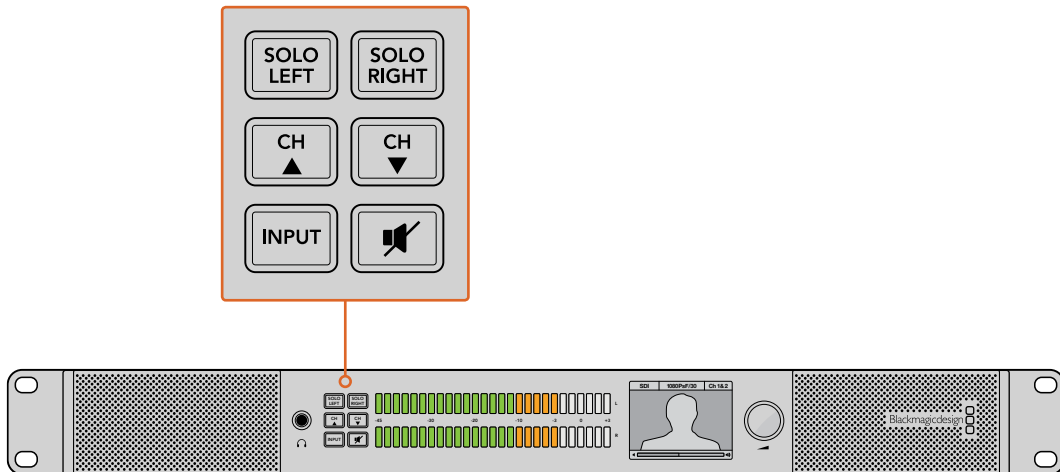

이 선택 버튼을 사용해 모니터링 하고자 하는 입력을 선택하고 좌/우 스테레오 채널을 분리할 수 있으며, 사용 가능한 오디오 채널을 위/아래로 이동하거나 스피커 또는 헤드폰을 음소거 할 수 있습니다.

Blackmagic Audio Monitor 사용하기

제어 패널 사용하기

Blackmagic Audio Monitor의 제어 패널을 통해 주요 기능 및 상태 정보로 신속하게 이동할 수 있습니다.

LCD

내장 컬러 LCD에 텍스트 오버레이 기능이 탑재되어 선택한 입력과 비디오 포맷(SDI를 연결한 경우), 선택한 오디오 채널, 스피커 또는 헤드폰 볼륨 레벨 등의 주요 상태 정보가 나타납니다. LCD는 또한 수신되는 모든 SDI 비디오 신호를 표시합니다. SDI 영상이 감지되지 않을 시에는 화면에 음악 아이콘이 나타납니다.

선택한 입력에 따라 다음과 같은 정보가 나타납니다.

SDI 입력

SDI, 비디오 포맷, 선택한 오디오 채널

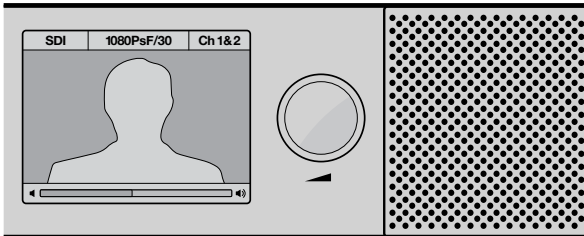

연결 유형과 비디오 포맷, 선택한 오디오 채널과 볼륨 레벨등의 오디오 및 비디오 정보가 컬러 LCD에 표시됩니다.

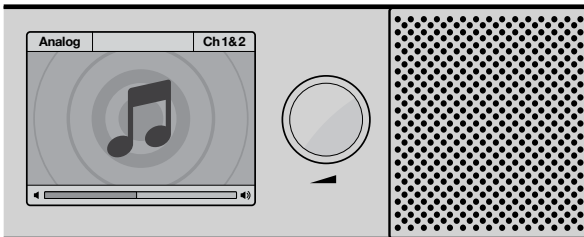

SDI 비디오 신호를 모니터링하는 경우를 제외하고는 LCD에 음악 아이콘이 나타납니다.

균형 AES/EBU XLR 입력

AES/EBU, 선택한 오디오 채널

균형 XLR 아날로그 입력

아날로그, 선택한 오디오 채널

불균형 RCA 아날로그 입력

HiFi, 선택한 오디오 채널

오디오 레벨 미터

Blackmagic Audio Monitor의 레벨 미터는 오디오 레벨의 세기를 나타내는 초록/주황/빨강으로 구성된 두 줄짜리 LED 미터입니다. 오디오 레벨이 너무 높아 클리핑될 경우에는 LED 전체에 불이 들어옵니다.

Audio Monitor Setup 유틸리티에서 선택한 오디오 미터 유형에 따라 오디오 레벨 미터의 움직임이 달라집니다. VU 미터링을 사용할 경우, 오디오 장비의 출력 레벨을 조정하여 제어 패널에 있는 오디오 미터의 피크 레벨이 0dB 부근에 머무르도록 합니다. 이는 신호대잡음비를 최대화시켜 오디오 품질이 최적의 상태로 유지됩니다. 오디오 피크 레벨이 0dB을 넘어설 경우, 오디오가 왜곡될 가능성이 높습니다.

Blackmagic Audio Monitor Setup 설치 및 오디오 레벨 미터 유형 설정 방법에 대한 자세한 정보는 [Audio Monitor Setup] 부분을 참고하세요.

SOLO LEFT 및 SOLO RIGHT 버튼

이 버튼을 사용해 좌/우 채널 오디오를 따로 들을 수 있어 각 채널에서 발생할 수 있는 모든 오디오 관련 문제를 개별적으로 모니터링할 수 있습니다.

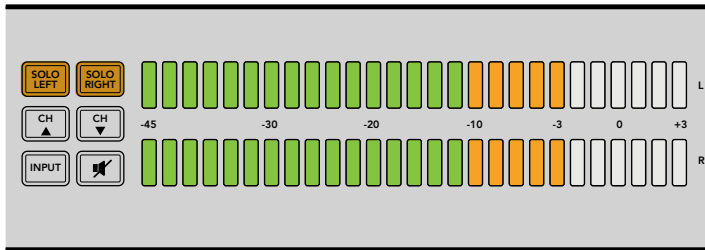

SOLO LEFT 버튼을 누르면 우측 오디오 채널이 비활성화됩니다. 오디오 레벨 미터에는 양쪽 채널이 그대로 표시됩니다.

좌측 채널 오디오 모니터링 방법

- 1 SOLO LEFT 버튼을 누르세요. 버튼에 녹색 배면광 불빛이 들어오며 좌측 스피커를 통해서만 오디오가 재생됩니다.
- 2 SOLO LEFT 버튼을 다시 한 번 누르면 스테레오 오디오 모니터링으로 되돌아갑니다.

우측 채널 오디오 모니터링 방법

- 1 SOLO RIGHT 버튼을 누르세요. 버튼에 녹색 배면광 불빛이 들어오며 우측 스피커를 통해서만 오디오가 재생됩니다.
- 2 SOLO RIGHT 버튼을 다시 한 번 누르면 스테레오 오디오 모니터링으로 되돌아갑니다.

채널 업 및 채널 다운 버튼

이 버튼(CH▲/CH▼)을 눌러 SDI 연결에 임베드된 오디오를 확인할 수 있습니다. 3G-SDI의 경우, 최대 16개의 채널 또는 8쌍의 채널을 지원합니다. 채널 업/다운(CH▲/CH▼) 버튼을 눌러 임베드 된 SDI 오디오 채널에서 위 아래로 움직일 수 있습니다.

Blackmagic Audio Monitor 12G는 최대 64개의 오디오 채널 또는 32쌍의 채널이 포함된 12G-SDI 입력을 지원합니다. CH▲/CH▼ 버튼을 길게 눌러 채널을 빠르게 스크롤할 수 있습니다.

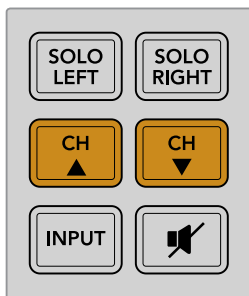

입력(Input) 버튼

INPUT 버튼을 반복적으로 눌러 SDI와 AES/EBU, 아날로그, HiFi 입력 간을 이동할 수 있어 모니터링하고자 하는 비디오 및 오디오 장비를 선택할 수 있습니다.

선택한 오디오 입력은 내장 스피커를 통해 확인이 가능하고 HDMI 출력의 CH1과 CH2에서 오디오를 모니터링할 수 있습니다.

참고 아날로그나 AES/EBU 또는 HiFi 입력이 선택될 시 HDMI 출력은 블랙 비디오로 나타납니다. SDI 루프 출력은 항상 SDI 입력에 연결된 비디오와 오디오를 출력합니다.

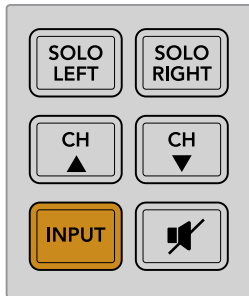

음소거 버튼

이 버튼을 누르면 Blackmagic Audio Monitor의 제어 패널 스피커와 헤드폰이 음소거 됩니다. 음소거 기능은 스피커와 헤드폰 출력에만 적용될 뿐 오디오 입력에는 아무런 영향을 끼치지 않습니다. MUTE 버튼을 다시 한 번 누르면 제어 패널 스피커와 헤드폰 오디오가 원래대로 복구됩니다. 오디오 볼륨을 높여도 오디오가 복구됩니다.

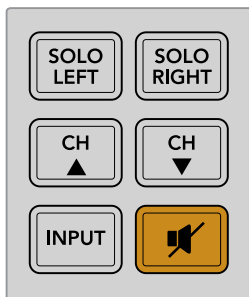

볼륨

이 노브를 사용해 스피커와 헤드폰을 볼륨을 개별적으로 조절할 수 있습니다. 볼륨 레벨이 내장 LCD에 표시됩니다. 헤드폰을 연결한 경우에는 Blackmagic Audio Monitor의 스피커가 음소거 되며, 헤드폰을 통해서만 오디오가 출력됩니다. 볼륨 노브를 시계 또는 반시계 방향으로 돌려 볼륨을 쉽게 조절할 수 있습니다.

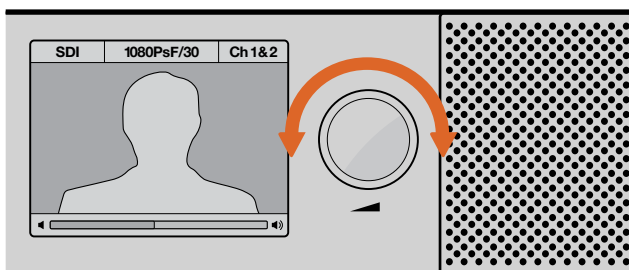

볼륨 레벨은 제어 패널 LCD에 표시됩니다.

Audio Monitor Setup

Blackmagic Audio Monitor Setup

Blackmagic Audio Monitor Setup 유틸리티를 통해 원하는 오디오 레벨 미터 유형을 설정할 수 있을 뿐만 아니라 Blackmagic Audio Monitor의 내부 소프트웨어도 업데이트할 수 있습니다.

이 셋업 유틸리티는 제품에 포함된 SD 카드를 사용해 업데이트할 수 있지만, Blackmagic Design 고객 지원 센터(www.blackmagicdesign.com/kr/support)에서 최신 버전을 다운로드할 것을 권장해 드립니다.

기존 Blackmagic Audio Monitor 모델을 컴퓨터 USB에 연결하면 환경 설정을 변경하고 셋업 유틸리티를 통해 내부 소프트웨어를 업데이트할 수 있습니다. Blackmagic Audio Monitor 12G 사용 시 이더넷을 통해 제품을 업데이트하고 설정을 변경할 수 있지만, 네트워크 설정 변경을 원할 시에는 USB를 통해 제품을 연결해야 합니다.

Blackmagic Audio Monitor Setup 소프트웨어는 macOS Mojave 10.14 혹은 이후 버전 그리고 Windows 10 버전에서 작동합니다.

macOS에 설치하기

- 1 제품과 함께 제공되는 미디어에서 설치 프로그램 파일을 더블 클릭하거나, Blackmagic Design 웹사이트에서 소프트웨어를 다운로드하여 다운로드 폴더에서 설치 프로그램 파일을 더블 클릭합니다.
- 2 화면에 나타나는 지시에 따르면 macOS가 자동으로 소프트웨어 설치를 시작합니다.

Windows에 설치하기

- 1 제품과 함께 제공되는 미디어에서 설치 프로그램 파일을 더블 클릭하거나, Blackmagic Design 웹사이트에서 소프트웨어를 다운로드하여 다운로드 폴더에서 설치 프로그램 파일을 더블 클릭합니다.
- 2 화면에 나타나는 지시에 따라 라이선스 계약 조건에 동의하면 Windows에서 자동으로 소프트웨어 설치를 시작합니다.

내부 소프트웨어 업데이트하기

- 1 USB 또는 이더넷을 통해 Blackmagic Audio Monitor를 컴퓨터에 연결합니다.
- 2 Blackmagic Audio Monitor Setup을 실행합니다.
- 3 환경 설정 아이콘을 클릭하면 유틸리티에서 업데이트 여부를 알려줍니다.
- 4 업데이트가 필요한 경우 [Update] 버튼을 누르면 소프트웨어 설치가 완료됩니다.



내부 소프트웨어 업데이트를 적용하려면 [Update] 버튼을 클릭하세요.



업데이트 진행 과정을 보여주는 진행 표시줄이 나타납니다.

- 5 업데이트가 완료되면 Close 버튼을 클릭하세요.



Blackmagic Audio Monitor Setup 유틸리티를 사용하면 Blackmagic Audio Monitor의 내부 소프트웨어를 업데이트하고 환경 설정을 변경할 수 있습니다.

Meter 탭

Blackmagic Audio Monitor Setup 유틸리티를 실행한 뒤, 환경 설정 아이콘을 클릭하면 오디오 레벨 미터 설정 화면이 나타납니다. EBU 및 BBC 측정 기준 선택이 가능한 PPM 또는 라우드니스와 VU 미터 유형 중 원하는 것을 선택할 수 있습니다. VU 미터가 표준으로 자리 잡은 반면, PPM과 라우드니스 미터는 인지할 수 있는 소리의 크기를 위한 단위 체계 및 측정을 제공합니다. 다음 페이지에 있는 표를 통해 지원 오디오 레벨 미터와 측정의 조합을 확인할 수 있습니다.

미터 유형	스케일 유형	측정 단위	사용 방법
VU	-	-45 ~ +3	제품에 표기
PPM	EBU	-12 ~ +13	스티커 라벨
PPM	BBC	1 ~ 7	스티커 라벨
Loudness	EBU +9	-18 ~ +9	스티커 라벨
Loudness	EBU +18	-36 ~ +18	스티커 라벨
Loudness	최대 +9	-41 ~ -14	스티커 라벨
Loudness	최대 +18	-59 ~ -5	스티커 라벨

VU

이 미터에는 오디오 신호 파형의 최고 및 최저 평균치가 표시됩니다. 대부분은 오디오 신호의 피크를 모니터링하는 데 사용하지만, VU는 평균값을 산출해내기 때문에 실제로 들리는 소리의 크기를 모니터링하는데 사용할 수도 있습니다.

PPM

이 미터는 일시적으로 신호의 피크를 유지한 후에 천천히 내려가는 피크 홀드 기능이 있어 오디오가 피킹되는 지점을 쉽게 확인할 수 있습니다.

Loudness

라우드니스 미터는 오디오 신호의 감각적인 크기를 나타냅니다. 오늘날의 방송 표준에는 일정한 라우드니스 레벨을 위한 라우드니스 미터링이 명시되어 있습니다.

VU와 PPM 미터는 -18dB 또는 -20dB로 선택할 수 있는 기준 레벨을 제공하여 각기 다른 국제 방송 표준에 맞는 오디오를 모니터링할 수 있습니다.

Blackmagic Audio Monitor의 LED 레퍼런스 움직임은 선택한 미터 유형에 따라 달라집니다. 정확한 dB 레퍼런스 단위가 표시된 스티커 라벨이 Blackmagic Audio Monitor와 함께 제공되어 오디오가 피킹되는 지점을 쉽게 확인할 수 있습니다. 원하는 단위의 스티커를 VU 단위가 표시된 컬러 LED 미터 사이에 붙이세요.

각 오디오 레벨 미터 유형과 측정 단위를 위한 라벨이 두 개씩 제공됩니다. 라벨 시트는 가까운 Blackmagic Design 지원 사무실에서 구할 수도 있습니다. Blackmagic Design 웹사이트의 고객 지원 센터에서 가까운 고객 지원 사무실을 검색할 수 있습니다.

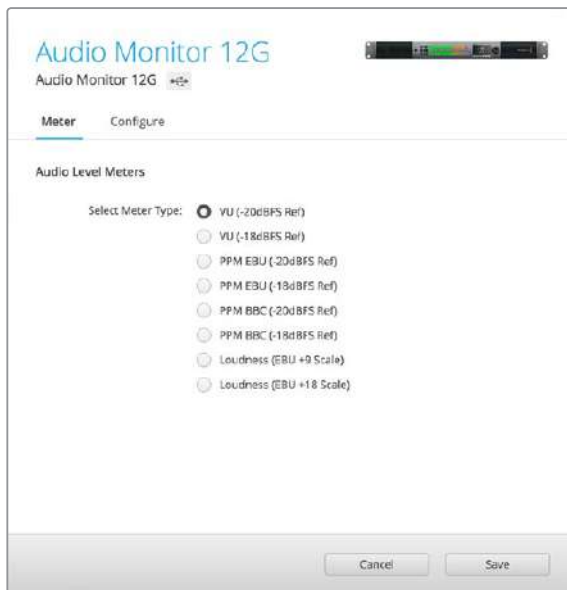

원하는 유형의 미터를 클릭한 뒤 Save를 클릭하여 Blackmagic Audio Monitor에 디스플레이할 미터 설정을 선택하세요.

EBU PPM									
-12	-8	-4	0	+4	+8	+12			
-12	-8	-4	0	+4	+8	+12			
BBC PPM									
1	2	3	4	5	6	7			
1	2	3	4	5	6	7			
Loudness Units EBU +9dB									
-18	-15	-12	-9	-6	-3	0	+3	+6	+9
-18	-15	-12	-9	-6	-3	0	+3	+6	+9
Loudness Units Fullscale +9dB									
-41	-38	-35	-32	-29	-26	-23	-20	-17	-14
-41	-38	-35	-32	-29	-26	-23	-20	-17	-14
Loudness Units EBU +18dB									
-36	-30	-24	-18	-12	-6	0	+6	+12	+18
-36	-30	-24	-18	-12	-6	0	+6	+12	+18
Loudness Units Fullscale +18dB									
-59	-53	-47	-41	-35	-29	-23	-17	-11	-5
-59	-53	-47	-41	-35	-29	-23	-17	-11	-5

미터 유형마다 정확한 오디오 피킹 위치를 확인할 수 있는 스티커 라벨이 함께 제공됩니다.

Configure 탭

Blackmagic Audio Monitor 12G에 추가로 있는 Configure 탭에는 소프트웨어 버전 번호와 Blackmagic Audio Monitor의 네트워크 설정이 포함되어 있습니다. 사용자는 또한 제품에 원하는 라벨명을 설정할 수 있습니다. 사용하는 제품에 이름을 설정하면 원격 연결 시 훨씬 빠르게 위치를 찾아낼 수 있습니다.

Blackmagic Audio Monitor 12G 제품명 설정

다음과 같이 Blackmagic Audio Monitor 12G 제품명을 설정하세요.

- 1 Configure 탭을 클릭합니다.
- 2 Details 설정에서 Name 옆에 있는 텍스트 상자를 클릭하고 새로운 라벨명을 입력하세요.
- 3 Save를 클릭하세요.



네트워크 설정 변경하기

네트워크를 통해 Blackmagic Audio Monitor 12G에 접속하면 여러 대의 제품을 쉽게 관리할 수 있습니다. Blackmagic Audio Monitor Setup에서 기기에 접속할 수 있습니다. Blackmagic Audio Monitor 12G는 자동으로 네트워크 주소를 할당하도록 기본 설정되어 있으므로 셋업 유틸리티 홈 스크린에서 바로 선택할 수 있습니다.

네트워크에서 Blackmagic Audio Monitor 12G를 찾기 어렵거나 이전에 설정한 Static 주소가 현재 네트워크와 호환되지 않을 경우 네트워크 설정을 직접 변경해야 할 수도 있습니다. USB를 통해서 연결할 수도 있습니다.

USB를 통해 네트워크 설정 변경하기

USB 연결을 통해 네트워크 설정을 변경하려면 Blackmagic Audio Monitor 12G를 USB 케이블로 Blackmagic Audio Monitor Setup을 사용하는 컴퓨터에 연결합니다. 뒷면 패널을 보면 Blackmagic Audio Monitor 12G의 USB 커넥터를 찾을 수 있습니다. 커넥터가 연결되면 Blackmagic Audio Monitor Setup에서 Audio Monitor 12G를 선택하고 Configure 탭으로 이동하세요. 이 탭에서 네트워크 주소를 Dynamic 또는 Static으로 선택할 수 있습니다. Static IP를 선택할 경우 IP 주소와 서브넷 마스크, 게이트웨이를 수동으로 입력할 수 있습니다.

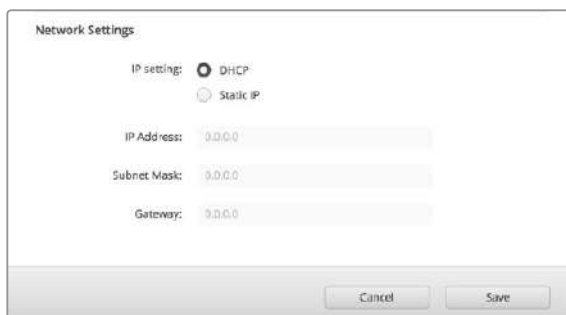

Blackmagic Dolby® Decoder Module 옵션 설치하기

돌비 디코더 모듈 제작은 중단되었지만, 가지고 있는 돌비 모듈을 설치하려면 이 페이지에 기재된 설명에 따라 다음과 같이 설치하세요.

참고 Blackmagic Audio Monitor 12G는 돌비 디코더 모듈 옵션을 지원하지 않습니다.

주의

모듈 설치 시 마더보드를 사용하기 위해 제품 뚜껑을 열어야 하므로 Blackmagic Audio Monitor의 전원 연결이 해제되었는지 확인한 뒤, Dolby 디코더 모듈을 설치하세요. 모듈 설치하는 반드시 전문가에게 의뢰하세요. 모듈 설치 시, 정전기 방전의 위험 예방을 위해 각별히 주의하세요.

모듈 설치하기

Blackmagic Dolby 디코더 모듈을 설치하면 최신 영화 및 TV 프로그램 제작에 사용되는 Dolby Digital 또는 Dolby E 오디오를 모니터링할 수 있습니다. Dolby 5.1 서라운드 사운드는 전면 좌/우 채널과 후면 서라운드 좌/우 채널, 중앙 채널뿐만 아니라 저음 주파수를 위한 채널에 인코딩됩니다.

Blackmagic Dolby 디코더는 72핀 SIMM 모듈로 Blackmagic Audio Monitor의 마더보드에 있는 SIMM 슬롯에 간단히 설치할 수 있습니다.

다음과 같은 방식으로 Blackmagic Dolby 디코더 모듈을 설치하세요.

- 1 Blackmagic Audio Monitor의 전원 연결을 해제하세요.
- 2 십자 드라이버를 사용하여 Blackmagic Audio Monitor 뚜껑의 21개 나사를 모두 풀니다. 뚜껑을 분리하세요.
- 3 Blackmagic Dolby 디코더 모듈의 접촉 부분이 SIMM 슬롯 부분을 향하도록 합니다. SIMM의 키 홈이 슬롯의 키에 잘 맞아야 SIMM이 제대로 장착됩니다.
- 4 접촉 부분이 완전히 장착될 때까지 모듈을 천천히 SIMM 슬롯에 집어넣습니다.
- 5 모듈이 양쪽 금속 클립에 잠길 때까지 Blackmagic Audio Monitor 뒷면 방향으로 모듈을 젖힙니다.
- 6 Blackmagic Audio Monitor의 뚜껑을 다시 덮고 21개의 나사를 조입니다.
Blackmagic Audio Monitor 디코더 모듈을 설치한 뒤, Dolby 모듈이 설치되었음을 쉽게 확인할 수 있도록 함께 제공된 Dolby 스티커를 Blackmagic Audio Monitor 뒷면 패널에 있는 경고 라벨 옆에 붙입니다.

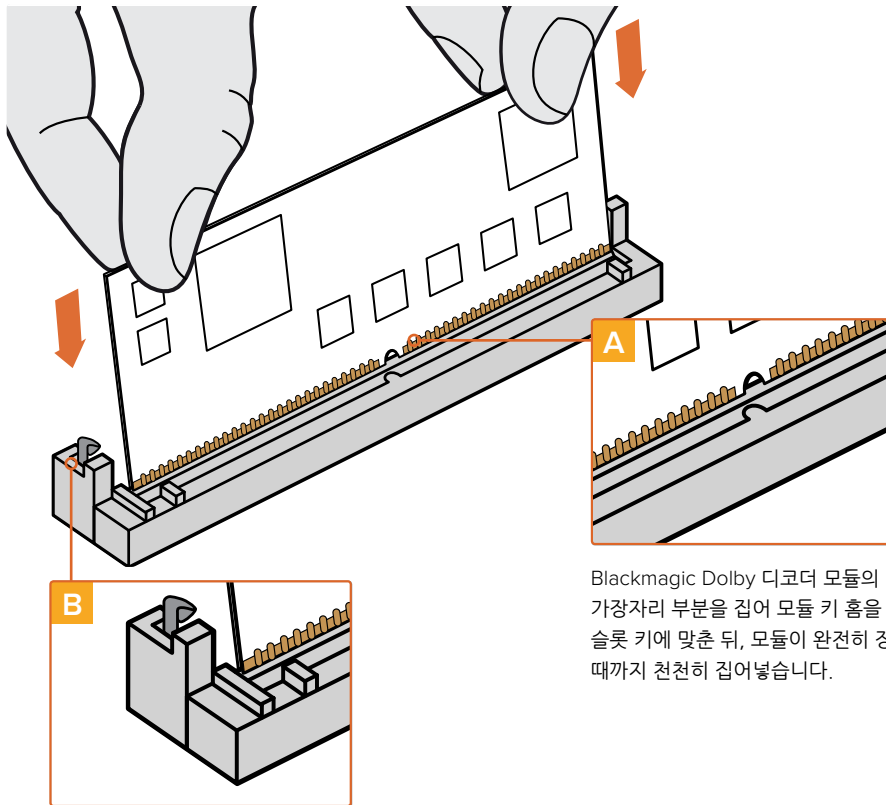

A
Blackmagic Dolby 디코더 모듈의 맨 가장자리 부분을 집어 모듈 키 홈을 SIMM 슬롯 키에 맞춘 뒤, 모듈이 완전히 장착될 때까지 천천히 집어넣습니다.

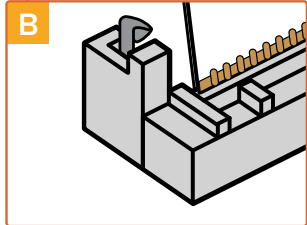

B
Blackmagic Dolby 디코더 모듈의 옆면이 금속 클립에 잠길 때까지 모듈을 새시 뒷면 방향으로 쪼입니다.

Dolby 오디오 확인하기

Blackmagic Audio Monitor에 Dolby 인코딩 오디오가 감지되면 제어 패널의 LCD 우측 상단에 Dolby 로고가 나타납니다. 제어 패널의 채널 위/아래 버튼을 눌러 네 쌍의 돌비 서라운드 채널을 모니터링할 수 있습니다.

Developer Information

Controlling Blackmagic Audio Monitor 12G using Telnet

The Blackmagic Audio Monitor 12G Ethernet Protocol gives you the freedom to build your own custom control solutions for your Blackmagic Audio Monitor 12G. For example, you can create your own software application or web interface to control your Blackmagic Audio Monitor 12G via Ethernet from your computer.

The first step is to connect your Blackmagic Audio Monitor 12G to your computer via Ethernet. You can do this by connecting to the same network your computer is connected to, or you can connect Blackmagic Audio Monitor 12G directly to your computer.

NOTE If Blackmagic Audio Monitor 12G is connected directly to your computer, set your computer to a manual static IP address. Set the first three blocks of numbers in the IP address to match your Blackmagic Audio Monitor 12G and set the subnet mask to 255.255.255.0. You can leave the gateway or router setting blank as it will not be used in a direct connection between your computer and Blackmagic Audio Monitor 12G.

If your network settings are set correctly, you can now open the Terminal application on macOS, or enable Telnet command line utilities on Windows and enter Blackmagic Audio Monitor 12G Ethernet Protocol commands. These commands can be programmed into your application and triggered by related items on a custom user interface of your own design.

Using Telnet on macOS and Windows

- 1 On macOS, open the Terminal application which is located within the Applications > Utilities folder.

To open the command prompt in Windows, click on the 'start' menu and type 'cmd' in the search bar. Press 'enter'.

- 2 Type in "telnet" and a space followed by the IP address of your computer, then another space and "9996", which is the default port number for Blackmagic Audio Monitor 12G.

For example:

```
telnet 192.168.25.253 9996
```

Press 'enter'. The Protocol Preamble screen will appear.

Blackmagic Audio Monitor 12G Ethernet Protocol V1.0

Summary

The Blackmagic Audio Monitor 12G Ethernet Protocol is a text based protocol that is accessed by connecting to TCP port 9996 on a Blackmagic Audio Monitor 12G.

The Blackmagic Audio Monitor 12G sends information in blocks which each have an identifying header in all-caps, followed by a full-colon. A block spans multiple lines and is terminated by a blank line.

Each line in the protocol is terminated by a new line character.

Upon connection, the Blackmagic Audio Monitor 12G sends a complete dump of the state of the device. After the initial status dump, status updates are sent every time the Blackmagic Audio Monitor 12G status changes.

To be resilient to future protocol changes, clients should ignore blocks they do not recognize, up to the trailing blank line. Within existing blocks, clients should ignore lines they do not recognize.

Legend

↵ line feed or carriage return
... and so on

Version 1.0 of the Blackmagic Audio Monitor 12G Ethernet Protocol was released with Blackmagic Audio Monitor 12G 3.0 software.

Protocol Preamble

The first block sent by the Blackmagic Audio Monitor 12G is always the protocol preamble:

```
PROTOCOL PREAMBLE:  
Version: 1.0
```

The version field indicates the protocol version. When the protocol is changed in a compatible way, the minor version number will be updated. If incompatible changes are made, the major version number will be updated.

Device Information

The next block contains general information about the connected Blackmagic Audio Monitor 12G device. If a device is connected, the Blackmagic Audio Monitor 12G will report the attributes of the Blackmagic Audio Monitor 12G:

```
AUDIOMONITOR DEVICE:↵  
Model: Blackmagic Audio Monitor 12G  
Label: Blackmagic Audio Monitor 12G
```

Only the label can be modified.

```
AUDIOMONITOR DEVICE:↵  
Label: My new name↵  
↵
```

The response will be

```
ACK:  
AUDIOMONITOR DEVICE:  
Label: My new name
```

The next block will show the network settings which can only be changed via the Blackmagic Audio Monitor Setup utility when connected over USB. This is for information only.

```
NETWORK:  
Dynamic IP: 1  
Current address: 0.0.0.0  
Current subnet: 0.0.0.0  
Current gateway: 0.0.0.0
```

The next block is the meter type.

```
AUDIO METER:  
Meter Mode: VU (-20dBFS Ref)
```

This can be changed to VU (-20dBFS Ref), VU (-18dBFS Ref), PPM EBU (-20dBFS Ref), PPM EBU (-18dBFS Ref), PPM BBC (-20dBFS Ref), PPM BBC (-18dBFS Ref), Loudness (EBU +9 scale) or Loudness (EBU +18 scale)

```
AUDIO METER:↵  
Meter Mode: Loudness (EBU +18 scale)↵  
↵
```

The response will be

```
ACK:  
AUDIO METER:  
Meter Mode: Loudness (EBU +18 scale)
```

The next block is the input type.

```
AUDIO INPUT:  
Routing: Speaker Stereo SDI Stereo 1-2
```

This can be changed to SDI Stereo 3-4, SDI Stereo 5-6, SDI Stereo 7-8, SDI Stereo 9-10, SDI Stereo 11-12, SDI Stereo 13-14, SDI Stereo 15-16, XLR AES/EBU Stereo 1-2, XLR Analog Stereo or RCA Stereo

```
AUDIO INPUT:↵  
Routing: Speaker Stereo XLR AES/EBU Stereo 1-2↵  
↵
```

The response will be

```
ACK:  
AUDIO INPUT:  
Routing: Speaker Stereo XLR AES/EBU Stereo 1-2
```

The next block is the audio output state. This indicates the current headphone and speaker volume settings as well as the state of the mute and solo buttons.

```
AUDIO OUTPUT:  
Gain: Speaker Stereo 0  
Gain: Headphone Stereo 0  
Mute: false  
Solo: Off
```

The volume gain settings can be set between 0 and 255. Mute can be true or false and Solo can be Off, Left or Right

```
AUDIO OUTPUT:↵  
Gain: Speaker Stereo 125↵  
Solo: Right↵  
↵
```

The response will be

```
ACK:  
AUDIO OUTPUT:  
Gain: Speaker Stereo 125  
Solo: Right
```

Checking the Connection

While the connection to the Blackmagic Audio Monitor 12G is established, a client may send a special no-operation command to check that the Blackmagic Audio Monitor 12G is still responding:

```
PING:↵  
↵
```

If the Blackmagic Audio Monitor 12G is responding, it will respond with an ACK message as for any other recognized command.

Checking valid Protocol Commands

While the connection to the Blackmagic Audio Monitor 12G is established, a client may send a special HELP command to obtain a list of supported Telnet commands:

```
HELP:↵  
↵  
AUDIOMONITOR DEVICE:  
Model: <label> [read only]  
Label: <label>  
Unique ID: <label> [read only]  
  
NETWORK:  
Dynamic IP: <boolean> [read only]  
Current address: <IP_address> [read only]  
Current subnet: <IP_address> [read only]  
Current gateway: <IP_address> [read only]  
  
AUDIO METER:  
Meter Mode: <enum> -> <enum> = <"VU (-20dBFS Ref)" | "VU (-18dBFS Ref)" |  
"PPM EBU (-20dBFS Ref)" | "PPM EBU (-18dBFS Ref)" | "PPM BBC (-20dBFS Ref)"  
| "PPM BBC (-18dBFS Ref)" | "Loudness (EBU +9 scale)" | "Loudness (EBU +18  
scale)">;  
  
AUDIO INPUT:  
Routing: <enum1> <enum2> -> <enum1> = <"Speaker Stereo">; <enum2> = <"SDI  
Stereo 1-2" | "SDI Stereo 3-4" | "SDI Stereo 5-6" | "SDI Stereo 7-8" | "SDI  
Stereo 9-10" | "SDI Stereo 11-12" | "SDI Stereo 13-14" | "SDI Stereo 15-16" |  
"XLR AES/EBU Stereo 1-2" | "XLR Analog Stereo" | "RCA Stereo">;  
  
AUDIO OUTPUT:  
Gain: <enum> <integer> -> <enum> = <"Speaker Stereo" | "Headphone Stereo">;  
<integer> = <0..255>;  
  
Mute: <boolean> -> <boolean> = <true | false>;  
  
Solo: <enum> -> <enum> = <"Off" | "Left" | "Right">;
```

지원

지원 받기

가장 빠르게 지원받을 수 있는 방법은 Blackmagic Design 온라인 고객지원 페이지에 접속하여 Blackmagic Audio Monitor 관련 최신 지원 정보를 확인하는 것입니다.

Blackmagic Design 온라인 고객 지원 페이지

최신 사용 설명서와 소프트웨어, 지원 노트는 Blackmagic 고객 지원 센터 (www.blackmagicdesign.com/kr/support)에서 확인하실 수 있습니다.

Blackmagic Design 포럼

저희 웹사이트에 있는 Blackmagic Design 포럼은 유용한 정보를 제공하는 곳으로, 방문을 통해 자세한 정보와 창의적인 아이디어를 얻을 수 있습니다. 또한, 숙련된 사용자들이나 Blackmagic Design 직원들이 기존에 올려놓은 해결책을 통해 원하는 해답을 얻을 수도 있으므로 여러 가지 도움을 빠르게 받아 한 단계 성장할 수 있는 방법이기도 합니다. 포럼은 <http://forum.blackmagicdesign.com/>를 통해 방문할 수 있습니다.

Blackmagic Design 고객 지원에 문의하기

고객 지원 페이지나 포럼에서 원하는 정보를 얻지 못한 경우에는 [이메일 보내기] 버튼을 클릭하여 지원 요청 이메일을 보내주세요. 다른 방법으로는, 고객 지원 페이지의 [지역별 고객 지원팀 찾기] 버튼을 클릭하여 가장 가까운 Blackmagic Design 고객 지원 사무실에 문의하실 수 있습니다.

현재 설치된 소프트웨어 버전 확인하기

컴퓨터에 설치된 Blackmagic Audio Monitor Setup 버전을 확인하려면 [About Blackmagic Audio Monitor Setup] 창을 여세요.

- macOS를 사용 시, 애플리케이션 폴더에서 'Blackmagic Audio Monitor Setup' 소프트웨어를 엽니다. 그 다음, 메뉴에서 'About Blackmagic Audio Monitor Setup'을 선택하여 버전을 확인하세요.
- Windows 10에서는 시작 페이지에 있는 'Blackmagic Audio Monitor Setup' 타일에서 'Blackmagic Audio Monitor Setup'을 실행하세요. 'Help' 메뉴를 클릭한 후, 'About Blackmagic Audio Monitor Setup'를 선택하고 버전을 확인하세요.

최신 버전 소프트웨어 업데이트하기

컴퓨터에 설치된 Blackmagic Audio Monitor Setup 버전을 확인한 뒤, Blackmagic Design 고객 지원 센터(www.blackmagicdesign.com/kr/support)에 방문하여 최신 업데이트 여부를 확인하세요. 최신 버전으로 업데이트하는 것을 권장하지만, 중요한 프로젝트를 실행하는 도중에는 소프트웨어 업데이트를 하지 않는 것이 좋습니다.

규제 사항

유럽 연합 국가 내의 전기전자제품 폐기물 처리기준



제품에 부착된 기호는 해당 제품을 다른 폐기물과는 별도로 처리되어야 함을 나타냅니다. 제품을 폐기하려면 반드시 재활용 지정 수거 장소에 폐기해야 합니다. 폐기물 제품을 분리수거 및 재활용으로 처리하는 것은 자연 자원을 보전하고 인간의 건강과 환경을 보호할 수 있도록 폐기물을 재활용할 수 있는 방법입니다. 재활용을 위한 제품 폐기물 장소에 관한 자세한 정보는 해당 지역 시청의 재활용 센터 혹은 해당 제품을 구입한 상점으로 문의하십시오.



본 제품은 테스트 결과 FCC 규정 제15항에 따라 A급 디지털 기기 제한 사항을 준수하는 것으로 확인되었습니다. 해당 제한 사항은 본 제품을 상업적 환경에서 사용할 시 발생할 수 있는 유해 혼선으로부터 적절한 보호를 제공하기 위함입니다. 이 제품은 무선 주파수를 생성 및 사용, 방출할 수 있습니다. 따라서 설명서의 안내에 따라 제품을 설치 및 사용하지 않을 시, 무선 통신을 방해하는 전파 혼선을 일으킬 수 있습니다. 해당 제품을 주거 지역에서 사용할 경우 유해 전파 혼선이 발생할 가능성이 있으며, 이 경우 사용자는 자체 비용으로 전파 혼선 문제를 해결해야 합니다.

제품 작동은 다음 두 가지 조건을 전제로 합니다.

- 1 본 기기는 유해 혼신을 일으키지 않습니다.
- 2 본 기기는 원치 않는 작동을 일으킬 수 있는 혼신을 포함하여 모든 혼신을 수용합니다.

ISED 캐나다 성명

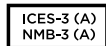

본 기기는 캐나다 표준 A급 디지털 장치 규정을 준수합니다.

정해진 사용 목적 이외의 다른 목적의 사용 또는 제품 변경은 표준 규정 위반으로 간주할 수 있습니다.

HDMI 인터페이스 연결 시에는 반드시 고품질의 실드 HDMI 케이블을 사용해야 합니다.

이 기기는 업무용 환경에서 사용할 목적으로 적합성 평가를 받은 기기로서 가정용 환경에서 사용하는 경우,

전파간섭의 우려가 있습니다.

안전 정보

감전 예방을 위하여 본 제품은 반드시 보호 접지가 되어 있는 메인 콘센트에 연결해야 합니다. 확실하지 않을 경우 자격증이 있는 전기공에 연락하십시오.

감전사고 위험을 줄이기 위해서 본 제품을 물이 튀거나 젖는 곳에 두지 마십시오.

본 제품은 주위 온도가 최대 40°C인 열대 지역에서 사용하기 적합합니다.

공기가 잘 통할 수 있도록 제품을 통풍이 잘되는 곳에 둡니다.

장비랙에 제품을 설치할 시, 주변 장비가 제품 통풍에 방해가 되지 않도록 주의하세요.

제품 내부에는 사용자가 수리 가능한 부품이 없습니다. 제품 수리는 해당 지역 Blackmagic Design 서비스 센터에 문의하세요.



최대 작동 고도는 해수면 기준 2000m입니다.

캘리포니아주 성명

본 제품을 사용하는 사용자는 제품의 플라스틱 내 폴리브롬화 비페닐에 노출될 수 있으며 캘리포니아주에서는 해당 물질이 암, 선천적 결손증, 기타 생식기능의 손상을 유발하는 것으로 알려져 있습니다.

더욱 자세한 정보는 www.P65Warnings.ca.gov을 확인하세요.

보증

12 개월 한정 보증

Blackmagic Design은 본 제품의 부품 및 제조에 어떠한 결함도 없음을 제품 구매일로부터 12개월 동안 보증합니다. 보증 기간 내에 결함이 발견될 경우, Blackmagic Design은 당사의 결정에 따라 무상 수리 또는 새로운 제품으로 교환해드립니다.

구매 고객은 반드시 보증 기간이 만료되기 전에 결함 사실을 Blackmagic Design에 통지해야 적절한 보증 서비스를 제공받을 수 있습니다. 구매 고객은 지정된 Blackmagic Design 서비스 센터로 결함 제품을 포장 및 운송할 책임이 있으며, 운송 비용은 선불로 지급되어야 합니다. 구매 고객은 또한 이유를 불문하고 제품 반송에 대한 운송료, 보험, 관세, 세금, 기타 비용을 부담해야 합니다.

이 보증은 부적절한 사용 및 관리, 취급으로 인한 파손, 고장, 결함에는 적용되지 않습니다. Blackmagic Design은 다음과 같은 경우에 보증 서비스를 제공할 의무가 없습니다. a) Blackmagic Design 판매 대리인이 아닌 개인에 의해 발생한 제품 손상. b) 부적절한 사용 및 호환하지 않는 장비와의 연결로 인한 제품 손상. c) Blackmagic Design사의 부품 및 공급품이 아닌 것을 사용하여 발생한 손상 및 고장. d) 제품을 개조하거나 다른 제품과 통합하여 제품 작동 시간 증가 및 기능 저하가 발생한 경우. BLACKMAGIC DESIGN에서 제공하는 제품 보증은 다른 모든 명시적 또는 묵시적 보증을 대신합니다. BLACKMAGIC DESIGN사와 관련 판매 회사는 상품성 및 특정 목적의 적합성과 관련된 모든 묵시적 보증을 부인합니다. 구매 고객에게 제공되는 BLACKMAGIC DESIGN의 결함 제품 수리 및 교환 관련 책임은 BLACKMAGIC DESIGN 또는 판매 회사에서 관련 위험의 가능성에 대한 사전 통보의 여부와 관계없이 모든 간접적, 특별, 우발적, 결과적 손해에 대한 유일한 배상 수단입니다. BLACKMAGIC DESIGN은 고객이 사용한 불법 장비에 대해서는 어떤 법적 책임도 지지 않습니다. BLACKMAGIC은 본 제품의 사용으로 인해 발생하는 손해에 대해서는 어떤 법적 책임도 지지 않습니다. 제품 사용으로 인해 발생할 수 있는 위험에 대한 책임은 본인에게 있습니다.

© Copyright 2020 Blackmagic Design. 모든 권리 보유. 'Blackmagic Design', 'DeckLink', 'HDLINK', 'Workgroup Videohub', 'Multibridge Pro', 'Multibridge Extreme', 'Intensity', 'Leading the creative video revolution'은 모두 미국 및 기타 국가에 등록된 상표입니다. 다른 회사명 및 제품 이름은 관련 회사의 등록 상표일 수 있습니다.



Руководство по установке и эксплуатации

Blackmagic Audio Monitor 12G

Январь 2020 г.

Русский



Добро пожаловать!

Благодарим вас за покупку Blackmagic Audio Monitor.

Мы стремимся к тому, чтобы телевидение стало областью настоящего творчества, в которой любой профессионал имеет доступ к оборудованию самого высокого качества.

Blackmagic Audio Monitor — компактное решение для профессионального контроля звука в телевидении, постпроизводстве и в прямом эфире. Устройство отличается высокой совместимостью и позволяет подключаться практически к любому аудиооборудованию. Оригинальная модель Blackmagic Audio Monitor с интерфейсом 6G-SDI предназначена для Ultra HD-видео с частотой до 30 кадров/с. Blackmagic Audio Monitor 12G с поддержкой 12G-SDI дает возможность работать с Ultra HD-материалом (до 60 кадров/с), а также обеспечивает прием сигнала 3G-SDI (Level A и Level B).

Это руководство содержит всю информацию, необходимую для работы с Blackmagic Audio Monitor.

Последнюю версию руководства и программного обеспечения для Blackmagic Audio Monitor можно найти в разделе поддержки на веб-сайте www.blackmagicdesign.com/ru.

Использование актуальной версии внутреннего ПО гарантирует доступ ко всем имеющимся функциям. Чтобы узнавать о выходе обновлений, зарегистрируйтесь при загрузке программного обеспечения. Мы постоянно работаем над совершенствованием наших продуктов, поэтому ваши отзывы помогут нам сделать их еще лучше!

Грант Петти

Генеральный директор Blackmagic Design

Содержание

Blackmagic Audio Monitor 12G

Подготовка к работе	159
Обзор Blackmagic Audio Monitor	159
Подключение источников аудио	159
Выбор источника звука	160
Подключение к видеовыходам	160
Работа с Blackmagic Audio Monitor	161
Работа с панелью управления	161
ЖК-дисплей	161
Индикаторы уровня звука	161
Solo Left и Solo Right	162
Переход между каналами	162
Input	163
Отключение звука	163
Громкость звука	163
Audio Monitor Setup	164
Blackmagic Audio Monitor Setup	164
Установка для macOS	164
Установка для Windows	164
Обновление внутреннего программного обеспечения	164
Вкладка Meter	165
Вкладка Configure	167
Изменение сетевых настроек	167
Изменение сетевых настроек через порт USB	167
Дополнительный модуль Blackmagic Design Dolby®	168
Установка модуля	168
Работа со звуком Dolby	169
Developer Information	170
Controlling Blackmagic Audio Monitor 12G using Telnet	170
Blackmagic Audio Monitor 12G Ethernet Protocol V1.0	170
Помощь	174
Соблюдение нормативных требований	175
Правила безопасности	176
Гарантия	177

Подготовка к работе

Обзор Blackmagic Audio Monitor

Blackmagic Audio Monitor и Blackmagic Audio Monitor 12G занимают одно место в стойке и обеспечивают точный контроль звуковой дорожки при работе в прямом эфире, во время телетрансляции и на этапе постпроизводства.

Blackmagic Audio Monitor позволяет подключаться к оборудованию с широким спектром разъемов: от SD/HD/3G/6G-SDI до цифрового AES/EBU- и аналогового интерфейсов. Модель Blackmagic Audio Monitor 12G с поддержкой 12G-SDI предназначена для Ultra HD-видео с частотой до 60 кадров/с. Светодиодные индикаторы левого и правого каналов показывают пиковые значения, а на встроенный ЖК-дисплей выводятся SDI-сигнал и дополнительная информация, в том числе тип соединения, формат видео, кадровая частота, номера каналов и уровень громкости.

Устройство обеспечивает мониторинг до 16 каналов звука, встроенного в SDI-сигнал, а также балансного аналогового и цифрового AES/EBU-аудио (через разъемы XLR). Для подключения к системам Hi-Fi и плеерам iPod дополнительно предусмотрен интерфейс RCA.

Blackmagic Audio Monitor имеет два встроенных динамика и два сабвуфера, которые обеспечивают качественное воспроизведение звука в широком диапазоне частот. При работе в шумной студии для мониторинга можно подключить наушники.



Blackmagic Audio Monitor 12G (передняя панель)



Blackmagic Audio Monitor 12G (задняя панель)

Подключение источников аудио

Blackmagic Audio Monitor поддерживает работу практически с любым звуковым оборудованием. Для контроля аудиодорожки в SD-, HD-, 2K- или Ultra HD-видео источник подключают через стандартный BNC-разъем. Модель с интерфейсом 12G-SDI обеспечивает прием сигнала 3G-SDI (Level A и Level B).

Для цифрового AES/EBU-звука, поступающего с дисковых рекордеров и музыкальных приставок, а также для аналогового оборудования (аудиомикшеры и Betacam SP) необходимо использовать XLR-разъемы. Аналоговую бытовую технику (видеомагнитофоны и DVD-плееры) можно подключить через интерфейс RCA. Чтобы устранить влияние посторонних шумов, рекомендуется применять наушники, для которых предусмотрен разъем 1/4 дюйма.

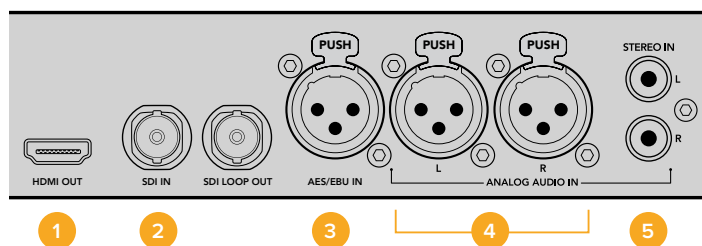

1. HDMI 2. Звук, встроенный в SDI-сигнал 3. XLR для AES/EBU
4. XLR для аналогового аудио 5. RCA для подключения бытовой техники

Выбор источника звука

После подключения Blackmagic Audio Monitor к оборудованию необходимо задать используемый вход. Для этого нажмите кнопку INPUT на передней панели. Когда на выбранный вход поступает аудиосигнал, загораются светодиодные индикаторы уровня звука. Они представляют собой двухрядную цветную шкалу, разбитую на сектора.

Кнопка INPUT предназначена для выбора типа соединения, который выводится на ЖК-дисплей вместе с дополнительной информацией, такой как используемый интерфейс, номера каналов и уровень громкости. Теперь Blackmagic Audio Monitor можно использовать для мониторинга аудиодорожки.

Подключение к видеовыходам

Если вместе с аудиодорожкой необходимо выводить видео, к Blackmagic Audio Monitor можно подключить большой дисплей или дополнительное оборудование.

Для мониторинга видео и встроенного в него звука можно использовать выход HDMI и сквозной интерфейс SDI.

Устройство обеспечивает вывод сигнала в SD, HD, 2K и Ultra HD по одному SDI-кабелю на такие платы захвата, как DeckLink 4K Extreme. Также допускается передача SD/HD-SDI-видео со встроенным аудио на записывающую деку, например HyperDeck Studio, а через HDMI — на современный Ultra HD-дисплей или проектор.

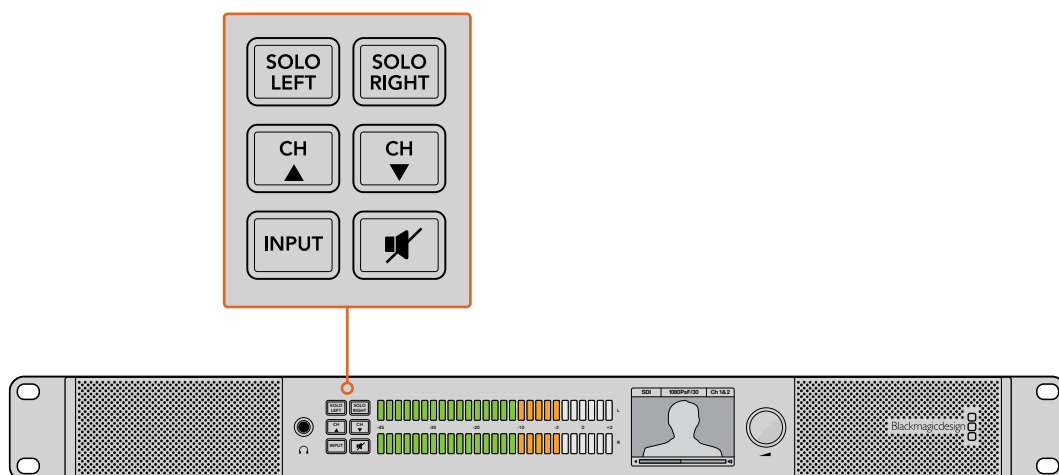

Кнопки на панели управления позволяют выбирать источник сигнала, изолировать левый или правый канал, переходить к нужной аудиопаре и отключать звук в динамиках или наушниках

Работа с Blackmagic Audio Monitor

Работа с панелью управления

Панель управления устройства обеспечивает доступ к основным функциям и индикаторам состояния.

ЖК-дисплей

На встроенный цветной ЖК-дисплей поступает информация о состоянии системы, в том числе выбранный вход, формат (при SDI-подключении), номера аудиоканалов и громкость звука для динамиков или наушников. На дисплей также выводится любое видео, поступающее на SDI-интерфейс. При отсутствии сигнала отображается нотный знак.

При выборе каждого из входов на дисплей выводится несколько параметров.

Вход SDI

Тип соединения (SDI), формат видео, выбранные аудиоканалы.

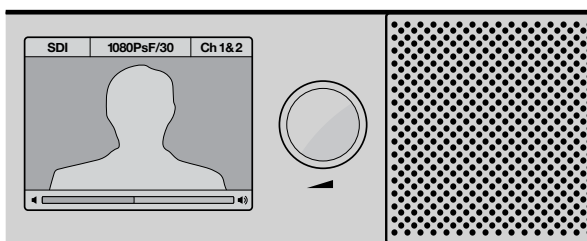

На цветной ЖК-дисплее выводятся тип соединения, формат видео, номера выбранных каналов и громкость звука

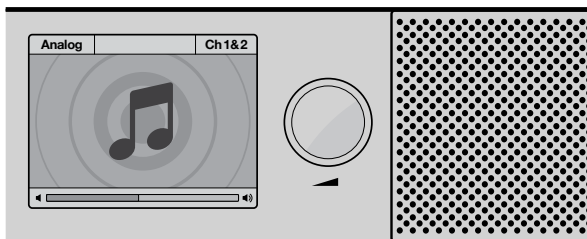

Если для мониторинга не используется SDI-сигнал, на ЖК-дисплее отображается нотный знак

Балансный XLR-вход для AES/EBU-звука

Тип соединения (AES/EBU), выбранные аудиоканалы.

Балансные XLR-входы для аналогового звука

Тип соединения (Analog), выбранные аудиоканалы.

Небалансные RCA-входы для аналогового звука

Hi-Fi, выбранные аудиоканалы.

Индикаторы уровня звука

Два ряда светодиодных индикаторов зеленого, оранжевого и красного цвета показывают громкость звука. Если они все горят, его уровень превышает допустимые параметры, то есть имеет место перегрузка.

Характер индикации будет меняться в зависимости от типа измерения, выбранного с помощью утилиты Blackmagic Audio Monitor Setup. При использовании опции VU пиковые значения не должны превышать 0 дБ на панели управления. Это максимально увеличивает соотношение «сигнал – шум» и обеспечивает самое высокое качество аудиодорожки. Если пиковые значения превышают уровень 0 дБ, возникает риск искажения звука.

Подробнее о работе с утилитой Blackmagic Audio Monitor Setup и типах шкалы см. раздел “Audio Monitor Setup”.

Solo Left и Solo Right

Эти кнопки позволяют изолировать левый или правый канал для отдельного прослушивания.

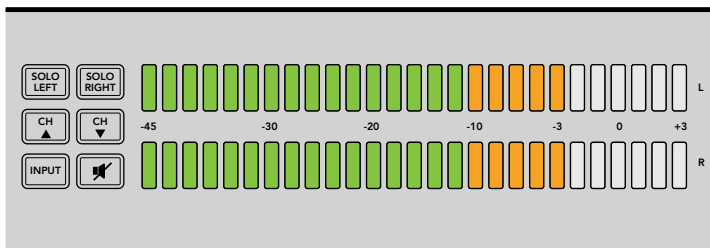

Кнопка Solo Left отключает вывод звука на правом канале, однако индикация сохраняется для обоих уровней

Мониторинг левого аудиоканала

- 1 Нажмите кнопку Solo Left. Она загорится зеленым цветом, и звук будет поступать только на левый динамик.
- 2 Чтобы вернуться к стереорежиму, нажмите Solo Left еще раз.

Мониторинг правого аудиоканала

- 1 Нажмите кнопку Solo Right. Она загорится зеленым цветом, и звук будет поступать только на правый динамик.
- 2 Чтобы вернуться к стереорежиму, нажмите Solo Right еще раз.

Переход между каналами

Эти кнопки позволяют использовать ту или иную пару каналов звука, встроенного в SDI-сигнал. При работе с 3G-SDI в общей сложности доступно 16 каналов, т. е. восемь пар. Нужную из них выбирают с помощью кнопок со стрелками вверх и вниз.

Blackmagic Audio Monitor 12G позволяет работать с 12G-SDI, поддерживая 64 звуковых канала, т. е. 32 пары. Для перехода между парами нажмите и удерживайте кнопку со стрелкой вверх или вниз.

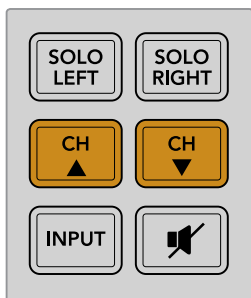

Input

При каждом нажатии кнопки INPUT можно перейти к одной из следующих опций: SDI, AES/EBU, Analog и Hi-Fi. Выберите ту из них, которая соответствует используемому входу.

Звук с выбранного аудиовхода можно выводить в наушники, а также проверять как каналы 1 и 2 на HDMI-выходе.

ПРИМЕЧАНИЕ. Если выбраны входы для аналогового звука, AES/EBU или Hi-Fi, на HDMI-выход поступает черное изображение. Через сквозной SDI-тракт всегда выводится сигнал с SDI-входа.

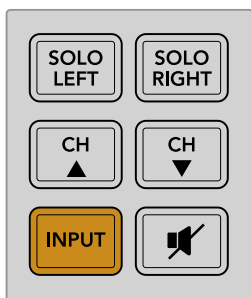

Отключение звука

Кнопка с перечеркнутым динамиком позволяет отключить звук в динамиках и наушниках. В этом случае сигнал по-прежнему поступает на вход устройства, но не воспроизводится. Чтобы возобновить вывод звука на динамики и в наушники, нажмите кнопку еще раз. Для этого можно также увеличить громкость с помощью поворотной ручки.

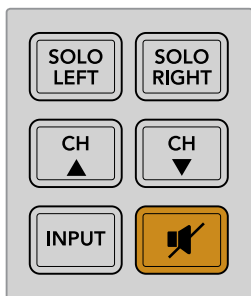

Громкость звука

Для изменения громкости звука в динамиках и наушниках служит поворотная ручка. Уровень отображается на встроенном ЖК-дисплее. При использовании гарнитуры динамики отключаются автоматически, после чего звуковой сигнал поступает в наушники. Громкость регулируют поворотом ручки по часовой стрелке или против часовой стрелки.

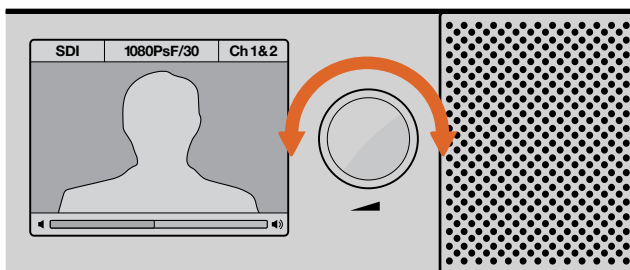

Уровень громкости отображается на ЖК-дисплее

Audio Monitor Setup

Blackmagic Audio Monitor Setup

Утилита Blackmagic Audio Monitor Setup служит для выбора шкалы индикации, а также для обновления внутреннего ПО на устройстве.

Для ее установки на компьютер можно использовать файл на прилагаемой SD-карте, однако лучше всего загрузить последнюю версию на странице поддержки Blackmagic Design по адресу www.blackmagicdesign.com/ru/support.

Если модель Blackmagic Audio Monitor подключена к ПК через разъем USB, утилита позволяет изменить параметры и обновить внутреннее ПО устройства. На Blackmagic Audio Monitor 12G эти действия можно также выполнить через порт Ethernet, однако для корректировки сетевых настроек требуется соединение через USB.

Утилита Blackmagic Audio Monitor Setup совместима с операционной системой Mojave 10.14 и более поздними версиями, а также Windows 10.

Установка для macOS

- 1 Дважды щелкните по установщику утилиты на электронном носителе или в папке загрузок (если приложение было загружено с веб-сайта Blackmagic Design).
- 2 Следуйте инструкциям на экране. macOS автоматически установит ПО.

Установка для Windows

- 1 Дважды щелкните по установщику утилиты на электронном носителе или в папке загрузок (если приложение было загружено с веб-сайта Blackmagic Design).
- 2 Следуйте инструкциям на экране. После согласия с условиями лицензионного соглашения Windows автоматически установит утилиту.

Обновление внутреннего программного обеспечения

- 1 Подключите Blackmagic Audio Monitor к компьютеру через порт USB или Ethernet.
- 2 Запустите утилиту Blackmagic Audio Monitor Setup.
- 3 Нажмите на значок настройки. Если требуется обновление, появится соответствующее сообщение.
- 4 Чтобы установить актуальную версию ПО, нажмите кнопку Update.



Для обновления ПО нажмите кнопку Update

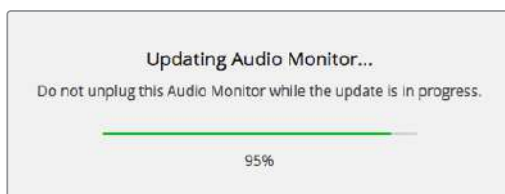

Индикатор выполнения задачи показывает состояние обновления

- 5 По окончании обновления нажмите кнопку Close.

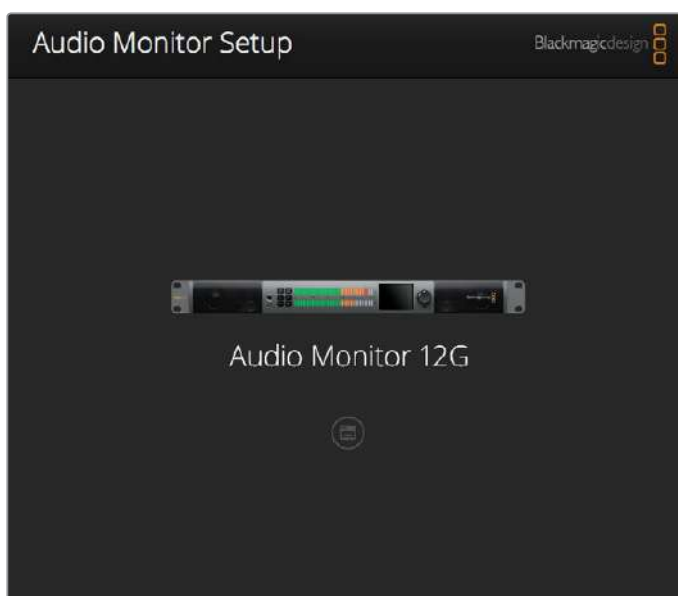

Утилита Blackmagic Audio Monitor Setup позволяет обновлять внутреннее ПО устройства и менять настройки

Вкладка Meter

После запуска утилиты нажмите на значок настроек, чтобы выбрать один из следующих видов индикации: VU, PPM или Loudness со шкалой EBU или BBC. Первая из них является стандартизированным инструментом, а PPM и Loudness измеряют воспринимаемую громкость. Таблица на следующей странице содержит перечень возможных типов индикации с указанием диапазона шкалы.

Тип индикации	Тип шкалы	Диапазон измерения	Способ применения
VU	–	от -45 до +3	Маркировка на устройстве
PPM	EBU	от -12 до +12	Дополнительная наклейка
PPM	BBC	от 1 до 7	Дополнительная наклейка
Loudness	EBU +9	от -18 до +9	Дополнительная наклейка
Loudness	EBU +18	от -36 до +18	Дополнительная наклейка
Loudness	Full Scale +9	от -41 до -14	Дополнительная наклейка
Loudness	Full Scale +18	от -59 до -5	Дополнительная наклейка

VU

Этот индикатор усредняет крайние значения аудиосигнала. В основном используется для мониторинга пиков, но поскольку он показывает средний уровень, его можно применять для измерения воспринимаемой громкости.

PPM

Этот индикатор наглядно фиксирует пиковые значения, чтобы их было легко отследить.

Loudness

Этот индикатор измеряет субъективную громкость звука. Современные стандарты вещания используют этот показатель для поддержания громкости на постоянном уровне.

Индикаторы VU и PPM позволяют выбирать опорное значение -18 дБ или -20 дБ, чтобы вести мониторинг на основе разных международных стандартов.

Характер индикации на Blackmagic Audio Monitor меняется в зависимости от типа измерения. В комплект поставки входят наклейки со шкалами, которые позволяют точно определить пиковые значения звука. Для использования нужной из них снимите защитный слой и поместите наклейку поверх маркировки VU, нанесенной на корпус устройства.

Для каждого типа измерений используется по две наклейки. Эти наборы также можно приобрести через местные представительства Blackmagic Design, адреса и телефоны которых указаны в разделе поддержки на странице www.blackmagicdesign.com/ru/support.



Выберите необходимый тип измерения и нажмите кнопку Save

EBU PPM									
-12	-8	-4	0	+4	+8	+12			
-12	-8	-4	0	+4	+8	+12			
BBC PPM									
1	2	3	4	5	6	7			
1	2	3	4	5	6	7			
Loudness Units EBU +9dB									
-18	-15	-12	-9	-6	-3	0	+3	+6	+9
-18	-15	-12	-9	-6	-3	0	+3	+6	+9
Loudness Units Fullscale +9dB									
-41	-38	-35	-32	-29	-26	-23	-20	-17	-14
-41	-38	-35	-32	-29	-26	-23	-20	-17	-14
Loudness Units EBU +18dB									
-36	-30	-24	-18	-12	-6	0	+6	+12	+18
-36	-30	-24	-18	-12	-6	0	+6	+12	+18
Loudness Units Fullscale +18dB									
-59	-53	-47	-41	-35	-29	-23	-17	-11	-5
-59	-53	-47	-41	-35	-29	-23	-17	-11	-5

Для точного измерения пиковых значений в комплект поставки входят наклейки со шкалами

Вкладка Configure

При работе с моделью Blackmagic Audio Monitor 12G утилита имеет дополнительную вкладку Configure, на которой указаны номер версии и сетевые параметры. Для облегчения идентификации устройства ему можно присвоить пользовательское имя.

Присвоение имени при работе с моделью Blackmagic Audio Monitor 12G

Порядок действий

- 1 Перейдите на вкладку Configure.
- 2 В настройках Details перейдите к текстовому полю Name и введите имя.
- 3 Нажмите Save.



Изменение сетевых настроек

Наиболее простой способ управления конфигурацией оборудования — доступ к Blackmagic Audio Monitor 12G через локальную сеть. Для этого можно использовать утилиту Blackmagic Audio Monitor Setup. По умолчанию сетевой адрес присваивается автоматически, поэтому для работы с устройством достаточно выбрать его на начальной странице.

Если вам не удастся обнаружить Blackmagic Audio Monitor 12G в сети или если устройству был присвоен статичный адрес, несовместимый с ее текущими параметрами, необходимо вручную изменить сетевые настройки. Эти действия можно выполнить через порт USB.

Изменение сетевых настроек через порт USB

Чтобы изменить сетевые параметры, используйте порт USB для подключения модели Blackmagic Audio Monitor 12G к компьютеру с утилитой Blackmagic Audio Monitor Setup. Разъем USB находится на задней панели устройства. После установки соединения выберите Audio Monitor 12G на начальной странице и перейдите ко вкладке Configure. Здесь можно установить динамичный или статичный сетевой адрес. Во втором случае вручную введите значения IP address, Subnet Mask и Gateway.

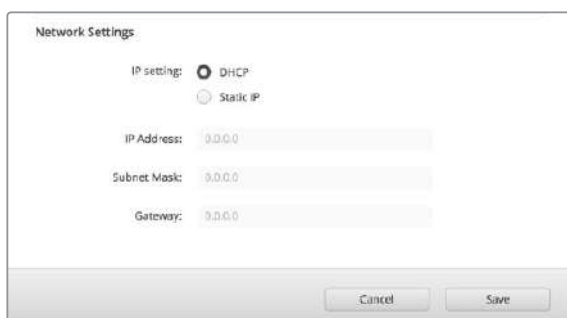

Дополнительный модуль Blackmagic Design Dolby®

В настоящее время компания Dolby прекратила выпуск модулей декодирования, однако если он был приобретен для оригинальной модели Blackmagic Audio Monitor, его установку можно выполнить в описанном ниже порядке.

ПРИМЕЧАНИЕ. Blackmagic Audio Monitor 12G не поддерживает работу с дополнительным модулем декодирования Dolby.

ПРЕДУПРЕЖДЕНИЕ

Перед установкой модуля декодирования Dolby необходимо отключить питание от Blackmagic Audio Monitor, потому что потребуется снять крышку корпуса для доступа к материнской плате. Эти действия должны выполняться только квалифицированным специалистом. Во избежание электростатического разряда соблюдайте меры предосторожности.

Установка модуля

Установленный модуль позволяет вести мониторинг звука Dolby Digital или Dolby E, используемого при создании современных фильмов и телепрограмм. Звуковая дорожка Dolby 5.1 Surround содержит каналы для передних (левый и правый) и задних динамиков (левый и правый), центрального динамика и отдельного сабвуфера для низких частот.

Декодер Dolby представляет собой 72-контактный модуль SIMM, который можно установить в специальный слот на материнской плате Blackmagic Audio Monitor.

Порядок установки модуля Dolby

- 1** Отключите устройство Blackmagic Audio Monitor от сети питания.
- 2** С помощью отвертки Phillips открутите 21 винт на крышке устройства. Снимите крышку.
- 3** Возьмите модуль так, чтобы его контакты были обращены к пустому слоту SIMM. Совместите гнездо с выступом слота.
- 4** Вставьте модуль SIMM в слот так, чтобы контакты были зафиксированы.
- 5** Наклоните модуль по направлению к задней панели устройства, чтобы защелкнуть металлические скобки с обеих сторон.
- 6** Поместите на место крышку и закрутите все винты.
После установки наклейте на заднюю панель стикер, который позволяет быстро идентифицировать устройство с модулем Dolby.

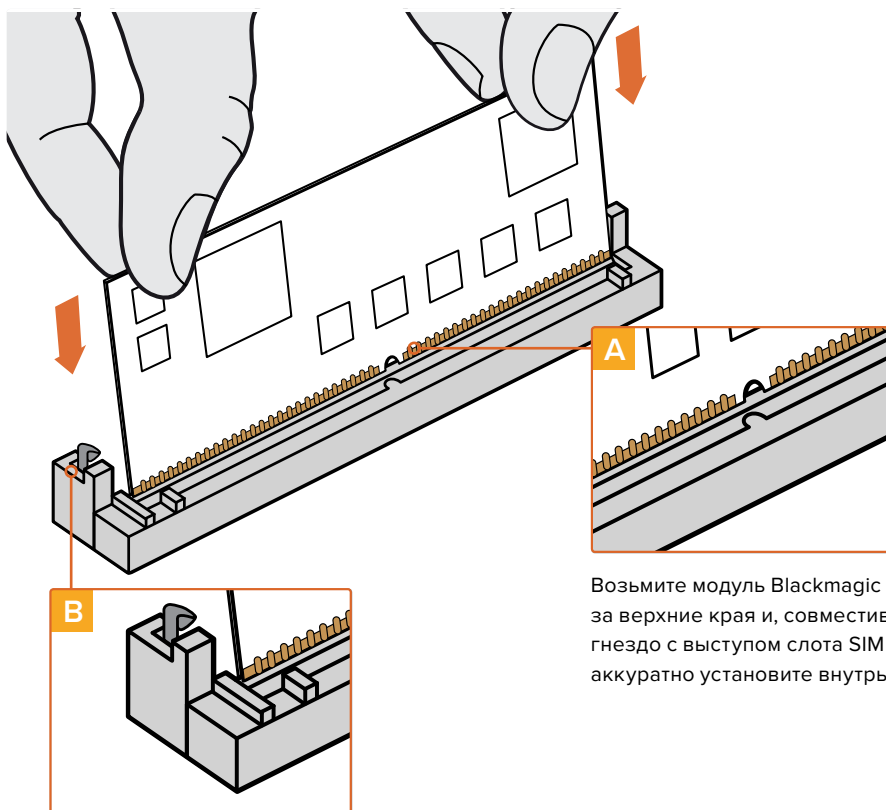

Возьмите модуль Blackmagic Dolby за верхние края и, совместив гнездо с выступом слота SIMM, аккуратно установите внутрь

Наклоните модуль Blackmagic Dolby по направлению к задней панели так, чтобы защелкнуть металлические скобки с обеих сторон

Работа со звуком Dolby

При получении звука в формате Dolby в верхнем правом углу ЖК-дисплея отображается соответствующий логотип. С помощью кнопок перехода между каналами можно выбрать четыре аудиопары Dolby Surround.

Developer Information

Controlling Blackmagic Audio Monitor 12G using Telnet

The Blackmagic Audio Monitor 12G Ethernet Protocol gives you the freedom to build your own custom control solutions for your Blackmagic Audio Monitor 12G. For example, you can create your own software application or web interface to control your Blackmagic Audio Monitor 12G via Ethernet from your computer.

The first step is to connect your Blackmagic Audio Monitor 12G to your computer via Ethernet. You can do this by connecting to the same network your computer is connected to, or you can connect Blackmagic Audio Monitor 12G directly to your computer.

NOTE If Blackmagic Audio Monitor 12G is connected directly to your computer, set your computer to a manual static IP address. Set the first three blocks of numbers in the IP address to match your Blackmagic Audio Monitor 12G and set the subnet mask to 255.255.255.0. You can leave the gateway or router setting blank as it will not be used in a direct connection between your computer and Blackmagic Audio Monitor 12G.

If your network settings are set correctly, you can now open the Terminal application on macOS, or enable Telnet command line utilities on Windows and enter Blackmagic Audio Monitor 12G Ethernet Protocol commands. These commands can be programmed into your application and triggered by related items on a custom user interface of your own design.

Using Telnet on macOS and Windows

- 1 On macOS, open the Terminal application which is located within the Applications > Utilities folder.

To open the command prompt in Windows, click on the 'start' menu and type 'cmd' in the search bar. Press 'enter'.

- 2 Type in "telnet" and a space followed by the IP address of your computer, then another space and "9996", which is the default port number for Blackmagic Audio Monitor 12G.

For example:

```
telnet 192.168.25.253 9996
```

Press 'enter'. The Protocol Preamble screen will appear.

Blackmagic Audio Monitor 12G Ethernet Protocol V1.0

Summary

The Blackmagic Audio Monitor 12G Ethernet Protocol is a text based protocol that is accessed by connecting to TCP port 9996 on a Blackmagic Audio Monitor 12G.

The Blackmagic Audio Monitor 12G sends information in blocks which each have an identifying header in all-caps, followed by a full-colon. A block spans multiple lines and is terminated by a blank line.

Each line in the protocol is terminated by a new line character.

Upon connection, the Blackmagic Audio Monitor 12G sends a complete dump of the state of the device. After the initial status dump, status updates are sent every time the Blackmagic Audio Monitor 12G status changes.

To be resilient to future protocol changes, clients should ignore blocks they do not recognize, up to the trailing blank line. Within existing blocks, clients should ignore lines they do not recognize.

Legend

↵ line feed or carriage return
... and so on

Version 1.0 of the Blackmagic Audio Monitor 12G Ethernet Protocol was released with Blackmagic Audio Monitor 12G 3.0 software.

Protocol Preamble

The first block sent by the Blackmagic Audio Monitor 12G is always the protocol preamble:

```
PROTOCOL PREAMBLE:  
Version: 1.0
```

The version field indicates the protocol version. When the protocol is changed in a compatible way, the minor version number will be updated. If incompatible changes are made, the major version number will be updated.

Device Information

The next block contains general information about the connected Blackmagic Audio Monitor 12G device. If a device is connected, the Blackmagic Audio Monitor 12G will report the attributes of the Blackmagic Audio Monitor 12G:

```
AUDIOMONITOR DEVICE:↵  
Model: Blackmagic Audio Monitor 12G  
Label: Blackmagic Audio Monitor 12G
```

Only the label can be modified.

```
AUDIOMONITOR DEVICE:↵  
Label: My new name↵  
↵
```

The response will be

```
ACK:  
AUDIOMONITOR DEVICE:  
Label: My new name
```

The next block will show the network settings which can only be changed via the Blackmagic Audio Monitor Setup utility when connected over USB. This is for information only.

```
NETWORK:  
Dynamic IP: 1  
Current address: 0.0.0.0  
Current subnet: 0.0.0.0  
Current gateway: 0.0.0.0
```

The next block is the meter type.

```
AUDIO METER:  
Meter Mode: VU (-20dBFS Ref)
```

This can be changed to VU (-20dBFS Ref), VU (-18dBFS Ref), PPM EBU (-20dBFS Ref), PPM EBU (-18dBFS Ref), PPM BBC (-20dBFS Ref), PPM BBC (-18dBFS Ref), Loudness (EBU +9 scale) or Loudness (EBU +18 scale)

```
AUDIO METER:↵  
Meter Mode: Loudness (EBU +18 scale)↵  
↵
```

The response will be

```
ACK:  
AUDIO METER:  
Meter Mode: Loudness (EBU +18 scale)
```

The next block is the input type.

```
AUDIO INPUT:  
Routing: Speaker Stereo SDI Stereo 1-2
```

This can be changed to SDI Stereo 3-4, SDI Stereo 5-6, SDI Stereo 7-8, SDI Stereo 9-10, SDI Stereo 11-12, SDI Stereo 13-14, SDI Stereo 15-16, XLR AES/EBU Stereo 1-2, XLR Analog Stereo or RCA Stereo

```
AUDIO INPUT:↵  
Routing: Speaker Stereo XLR AES/EBU Stereo 1-2↵  
↵
```

The response will be

```
ACK:  
AUDIO INPUT:  
Routing: Speaker Stereo XLR AES/EBU Stereo 1-2
```

The next block is the audio output state. This indicates the current headphone and speaker volume settings as well as the state of the mute and solo buttons.

```
AUDIO OUTPUT:  
Gain: Speaker Stereo 0  
Gain: Headphone Stereo 0  
Mute: false  
Solo: Off
```

The volume gain settings can be set between 0 and 255. Mute can be true or false and Solo can be Off, Left or Right

```
AUDIO OUTPUT:↵  
Gain: Speaker Stereo 125↵  
Solo: Right↵  
↵
```

The response will be

```
ACK:  
AUDIO OUTPUT:  
Gain: Speaker Stereo 125  
Solo: Right
```

Checking the Connection

While the connection to the Blackmagic Audio Monitor 12G is established, a client may send a special no-operation command to check that the Blackmagic Audio Monitor 12G is still responding:

```
PING:↵  
↵
```

If the Blackmagic Audio Monitor 12G is responding, it will respond with an ACK message as for any other recognized command.

Checking valid Protocol Commands

While the connection to the Blackmagic Audio Monitor 12G is established, a client may send a special HELP command to obtain a list of supported Telnet commands:

```
HELP:↵  
↵  
AUDIOMONITOR DEVICE:  
Model: <label> [read only]  
Label: <label>  
Unique ID: <label> [read only]  
  
NETWORK:  
Dynamic IP: <boolean> [read only]  
Current address: <IP_address> [read only]  
Current subnet: <IP_address> [read only]  
Current gateway: <IP_address> [read only]  
  
AUDIO METER:  
Meter Mode: <enum> -> <enum> = <"VU (-20dBFS Ref)" | "VU (-18dBFS Ref)" |  
"PPM EBU (-20dBFS Ref)" | "PPM EBU (-18dBFS Ref)" | "PPM BBC (-20dBFS Ref)"  
| "PPM BBC (-18dBFS Ref)" | "Loudness (EBU +9 scale)" | "Loudness (EBU  
+18 scale)">;  
  
AUDIO INPUT:  
Routing: <enum1> <enum2> -> <enum1> = <"Speaker Stereo">; <enum2> = <"SDI  
Stereo 1-2" | "SDI Stereo 3-4" | "SDI Stereo 5-6" | "SDI Stereo 7-8" | "SDI  
Stereo 9-10" | "SDI Stereo 11-12" | "SDI Stereo 13-14" | "SDI Stereo 15-16" |  
"XLR AES/EBU Stereo 1-2" | "XLR Analog Stereo" | "RCA Stereo">;  
  
AUDIO OUTPUT:  
Gain: <enum> <integer> -> <enum> = <"Speaker Stereo" | "Headphone Stereo">;  
<integer> = <0..255>;  
  
Mute: <boolean> -> <boolean> = <true | false>;  
  
Solo: <enum> -> <enum> = <"Off" | "Left" | "Right">;
```

Помощь

Как получить помощь

Самый быстрый способ получить помощь — обратиться к страницам поддержки на сайте Blackmagic Design и проверить наличие последних справочных материалов по Blackmagic Audio Monitor.

Страница поддержки на сайте Blackmagic Design

Последние версии руководства по эксплуатации, программного обеспечения и дополнительную информацию можно найти в разделе поддержки Blackmagic Design на странице www.blackmagicdesign.com/ru/support.

Форум сообщества Blackmagic Design

Посетите форум сообщества Blackmagic Design на нашем веб-сайте, чтобы получить дополнительную информацию и узнать об интересных творческих идеях. Там также можно найти ответы опытных пользователей и сотрудников Blackmagic Design на часто задаваемые вопросы. Адрес форума <http://forum.blackmagicdesign.com>.

Обращение в Службу поддержки Blackmagic Design

Если с помощью доступных справочных материалов и форума решить проблему не удалось, воспользуйтесь формой «Отправить нам сообщение» на странице поддержки. Можно также позвонить в ближайшее представительство Blackmagic Design, телефон которого вы найдете на нашем веб-сайте.

Проверка используемой версии программного обеспечения

Чтобы узнать версию Blackmagic Audio Monitor Setup, установленную на вашем компьютере, откройте окно About Blackmagic Audio Monitor Setup.

- На компьютере с операционной системой macOS откройте Blackmagic Audio Monitor Setup в папке «Приложения». В меню выберите About Blackmagic Audio Monitor Setup, чтобы узнать номер версии.
- При работе в операционной системе Windows 10 на экране «Пуск» выберите Blackmagic Audio Monitor Setup. В меню «Помощь» выберите About Blackmagic Audio Monitor Setup, чтобы узнать номер версии.

Загрузка последних версий программного обеспечения

Узнав установленную версию утилиты Blackmagic Audio Monitor Setup, перейдите в центр поддержки Blackmagic на странице www.blackmagicdesign.com/ru/support, чтобы проверить наличие обновлений. Рекомендуется всегда использовать последнюю версию программного обеспечения, однако обновление лучше всего выполнять после завершения текущего проекта.

Соблюдение нормативных требований

Утилизация электрооборудования и электронной аппаратуры в Европейском Союзе



Изделие содержит маркировку, в соответствии с которой его запрещается утилизировать вместе с бытовыми отходами. непригодное для эксплуатации оборудование необходимо передать в пункт вторичной переработки. Раздельный сбор отходов и их повторное использование позволяют беречь природные ресурсы, охранять окружающую среду и защищать здоровье человека. Чтобы получить подробную информацию о порядке утилизации, обратитесь в местные муниципальные органы или к дилеру, у которого вы приобрели это изделие.



Данное оборудование протестировано по требованиям для цифровых устройств класса А (раздел 15 спецификаций FCC) и признано соответствующим всем предъявляемым критериям. Соблюдение упомянутых нормативов обеспечивает достаточную защиту от вредного излучения при работе оборудования в нежилых помещениях. Так как это изделие генерирует и излучает радиоволны, при неправильной установке оно может становиться источником радиопомех. Если оборудование эксплуатируется в жилых помещениях, высока вероятность возникновения помех, влияние которых в этом случае пользователь должен устранить самостоятельно.

До эксплуатации допускаются устройства, соответствующие двум главным требованиям.

- 1 Оборудование не должно быть источником вредных помех.
- 2 Оборудование должно быть устойчивым к помехам, включая помехи, которые могут вызвать сбой в работе.

Соответствие требованиям ISED (Канада)

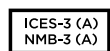

Данное оборудование соответствует канадским стандартам для цифровых устройств класса А.

Любая модификация или использование изделия не по назначению могут повлечь за собой аннулирование заявления о соответствии этим стандартам.

Подключение к HDMI-интерфейсу должно выполняться с помощью качественного экранированного кабеля.

Данное оборудование протестировано по требованиям, предъявляемым к устройствам при работе в нежилых помещениях. При использовании в бытовых условиях оно может становиться источником помех для радиосигнала.

Правила безопасности

Во избежание удара электрическим током розетка для подключения устройства к сети должна иметь заземляющий контакт. При необходимости обратитесь за помощью к квалифицированному электрику.

Чтобы минимизировать опасность поражения электрическим током, изделие необходимо защищать от попадания брызг и капель воды.

Допускается эксплуатация в условиях тропического климата с температурой окружающей среды до 40°C.

Для работы устройства необходимо обеспечить достаточную вентиляцию.

При установке в стойку убедитесь в том, что не нарушен приток воздуха.

Внутри корпуса не содержатся детали, подлежащие обслуживанию. Для выполнения ремонтных работ обратитесь в местный сервисный центр Blackmagic Design.



Допускается эксплуатация в местах не выше 2000 метров над уровнем моря.

Уведомление для жителей штата Калифорния

При работе с этим оборудованием существует возможность контакта с содержащимися в пластмассе микропримесями многобромистого бифенила, который в штате Калифорния признан канцерогеном и увеличивает риск врожденных дефектов и пороков репродуктивной системы.

Подробную информацию см. на сайте www.P65Warnings.ca.gov.

Гарантия

Ограниченная гарантия сроком 12 месяцев

Компания Blackmagic Design гарантирует отсутствие в данном изделии дефектов материала и производственного брака в течение 12 месяцев с даты продажи. Если во время гарантийного срока будут выявлены дефекты, Blackmagic Design по своему усмотрению выполнит ремонт неисправного изделия без оплаты стоимости запчастей и трудозатрат или заменит такое изделие новым.

Чтобы воспользоваться настоящей гарантией, потребитель обязан уведомить компанию Blackmagic Design о дефекте до окончания гарантийного срока и обеспечить условия для предоставления необходимых услуг. Потребитель несет ответственность за упаковку и доставку неисправного изделия в соответствующий сервисный центр Blackmagic Design с оплатой почтовых расходов. Потребитель обязан оплатить все расходы по доставке и страхованию, пошлины, налоги и иные сборы в связи с возвратом изделия вне зависимости от причины возврата.

Настоящая гарантия не распространяется на дефекты, отказы и повреждения, возникшие из-за ненадлежащего использования, неправильного ухода или обслуживания. Компания Blackmagic Design не обязана предоставлять услуги по настоящей гарантии: а) для устранения повреждений, возникших в результате действий по установке, ремонту или обслуживанию изделия лицами, которые не являются персоналом Blackmagic Design; б) для устранения повреждений, возникших в результате ненадлежащего использования или подключения к несовместимому оборудованию; в) для устранения повреждений или дефектов, вызванных использованием запчастей или материалов других производителей; г) если изделие было модифицировано или интегрировано с другим оборудованием, когда такая модификация или интеграция увеличивает время или повышает сложность обслуживания изделия. НАСТОЯЩАЯ ГАРАНТИЯ ПРЕДОСТАВЛЯЕТСЯ КОМПАНИЕЙ BLACKMAGIC DESIGN ВМЕСТО ЛЮБЫХ ДРУГИХ ПРЯМО ВЫРАЖЕННЫХ ИЛИ ПОДРАЗУМЕВАЕМЫХ ГАРАНТИЙ. КОМПАНИЯ BLACKMAGIC DESIGN И ЕЕ ДИЛЕРЫ ОТКАЗЫВАЮТСЯ ОТ ЛЮБЫХ ПОДРАЗУМЕВАЕМЫХ ГАРАНТИЙ КОММЕРЧЕСКОЙ ЦЕННОСТИ ИЛИ ПРИГОДНОСТИ ДЛЯ КАКОЙ-ЛИБО ОПРЕДЕЛЕННОЙ ЦЕЛИ. ОТВЕТСТВЕННОСТЬ BLACKMAGIC DESIGN ПО РЕМОНТУ ИЛИ ЗАМЕНЕ НЕИСПРАВНЫХ ИЗДЕЛИЙ ЯВЛЯЕТСЯ ПОЛНЫМ И ИСКЛЮЧИТЕЛЬНЫМ СРЕДСТВОМ ВОЗМЕЩЕНИЯ, ПРЕДОСТАВЛЯЕМЫМ ПОТРЕБИТЕЛЮ В СВЯЗИ С КОСВЕННЫМИ, ФАКТИЧЕСКИМИ, СОПУТСТВУЮЩИМИ ИЛИ ПОСЛЕДУЮЩИМИ УБЫТКАМИ, ВНЕ ЗАВИСИМОСТИ ОТ ТОГО, БЫЛА ИЛИ НЕТ КОМПАНИЯ BLACKMAGIC DESIGN (ЛИБО ЕЕ ДИЛЕР) ПРЕДВАРИТЕЛЬНО ИЗВЕЩЕНА О ВОЗМОЖНОСТИ ТАКИХ УБЫТКОВ. BLACKMAGIC DESIGN НЕ НЕСЕТ ОТВЕТСТВЕННОСТИ ЗА ПРОТИВОПРАВНОЕ ИСПОЛЬЗОВАНИЕ ОБОРУДОВАНИЯ СО СТОРОНЫ ПОТРЕБИТЕЛЯ. BLACKMAGIC DESIGN НЕ НЕСЕТ ОТВЕТСТВЕННОСТИ ЗА УБЫТКИ, ВОЗНИКАЮЩИЕ ВСЛЕДСТВИЕ ИСПОЛЬЗОВАНИЯ ЭТОГО ИЗДЕЛИЯ. РИСКИ, СВЯЗАННЫЕ С ЕГО ЭКСПЛУАТАЦИЕЙ, ВОЗЛАГАЮТСЯ НА ПОТРЕБИТЕЛЯ.

© Copyright 2020 Blackmagic Design. Все права защищены. Blackmagic Design, DeckLink, HDLink, Workgroup Videohub, Multibrige Pro, Multibrige Extreme, Intensity и "Leading the creative video revolution" зарегистрированы как товарные знаки в США и других странах. Названия других компаний и наименования продуктов могут являться товарными знаками соответствующих правообладателей.



Manuale di istruzioni

Blackmagic Audio Monitor 12G

Gennaio 2020

Italiano



Gentile utente

Benvenuto e benvenuta

Grazie per aver acquistato Blackmagic Audio Monitor.

Il nostro obiettivo è dare a ciascuno l'opportunità di accedere a dispositivi video di massima qualità, così stimolando la creatività dell'industria televisiva.

Il monitoraggio audio è essenziale per qualsiasi workflow di produzione video, incluse le trasmissioni broadcast, la post produzione, e le produzioni in diretta. Blackmagic Audio Monitor offre tutte le funzioni dei sistemi di monitoraggio professionali in un design compatto per rack. Grazie all'ampia connettività, è compatibile con qualsiasi tipo di sorgente audio e garantisce prestazioni eccellenti. Il modello originale di Blackmagic Audio Monitor supporta il 6G-SDI per il video Ultra HD fino a 30 fps. Il nuovo modello Blackmagic Audio Monitor 12G supporta il 12G-SDI per il video Ultra HD fino a 60 fps, e ammette il video 3G-SDI di livello A e B.

Il manuale di istruzioni contiene tutte le informazioni per installare e utilizzare Blackmagic Audio Monitor.

La versione più recente di questo manuale e gli aggiornamenti del software Blackmagic Audio Monitor sono disponibili sul nostro sito alla pagina www.blackmagicdesign.com/it. È importante aggiornare il software regolarmente per disporre delle ultime funzioni. Una volta scaricato il software, registra i tuoi dati personali per ricevere le notifiche sugli aggiornamenti futuri. Blackmagic è in costante stato di innovazione. Ti invitiamo a lasciare i tuoi preziosi suggerimenti per consentirci di migliorare prestazioni e funzionalità.

A stylized, handwritten signature in black ink that reads "Grant Petty". The signature is fluid and cursive.

Grant Petty

AD di Blackmagic Design

Indice

Blackmagic Audio Monitor 12G

Operazioni preliminari	181
Blackmagic Audio Monitor	181
Collegare la fonte audio	181
Selezionare la fonte audio	182
Connettere le uscite video	182
Utilizzare Blackmagic Audio Monitor	183
Utilizzare il pannello di controllo	183
Display LCD	183
Indicatori di livello	183
Pulsanti SOLO LEFT e SOLO RIGHT	184
Pulsanti canale CH	184
INPUT	185
Mute	185
Manopola volume	185
Utilità Audio Monitor Setup	186
Blackmagic Audio Monitor Setup	186
Installazione su macOS	186
Installazione su Windows	186
Aggiornare il software interno	186
La tab Meter	187
La tab Configure	189
Cambiare le impostazioni di rete	189
Installare il modulo opzionale Blackmagic Dolby® Decoder Module	190
Installare il modulo	190
Confermare l'audio Dolby	191
Developer Information	192
Controlling Blackmagic Audio Monitor 12G using Telnet	192
Blackmagic Audio Monitor 12G Ethernet Protocol V1.0	192
Assistenza	196
Normative	197
Sicurezza	198
Garanzia	199

Operazioni preliminari

Blackmagic Audio Monitor

Dal design di una unità di rack, Blackmagic Audio Monitor e Blackmagic Audio Monitor 12G sono soluzioni di monitoraggio in tempo reale di un'ampia varietà di segnali AV durante le produzioni in diretta, le trasmissioni broadcast, e la post produzione.

Le connessioni di Blackmagic Audio Monitor ammettono SD/HD/3G/6G-SDI, audio digitale AES/EBU e analogico per garantire i corretti livelli audio in uscita. Il modello 12G supporta il 12G-SDI per connettere video Ultra HD fino a 60 fps. Gli indicatori di livello a LED denotano il picco del segnale, e il display LCD integrato mostra le immagini dell'ingresso video SDI, e altre informazioni tra cui il tipo di connessione in entrata, il formato, il frame rate, i canali audio e il volume.

Consente di monitorare fino a 16 canali SDI con audio integrato, oppure sfruttare i connettori XLR per i segnali di audio analogico bilanciato o digitale AES/EBU. Ospita anche connettori RCA per collegare strumentazione di largo consumo tra cui i sistemi HiFi e gli iPod.

Blackmagic Audio Monitor include due altoparlanti a banda larga di alta qualità e due subwoofer dall'ampio intervallo di frequenze che riproducono un suono pulito e profondo. Inoltre integra un ingresso per cuffie per fare monitoraggio audio di precisione negli ambienti rumorosi.

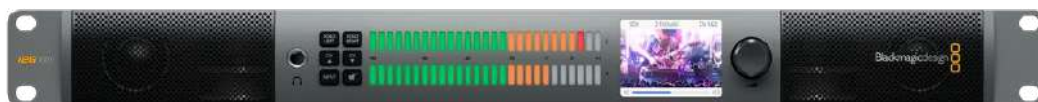

Il pannello frontale di Blackmagic Audio Monitor 12G.



Il retro di Blackmagic Audio Monitor 12G.

Collegare la fonte audio

Blackmagic Audio Monitor è compatibile con qualsiasi tipo di dispositivo audio. Per connettere i segnali SDI in SD, HD, 2K o Ultra HD basta inserire un connettore BNC standard nell'ingresso SDI. Il modello 12G ammette il video in entrata 3G-SDI di livello A e B.

Collega connettori XLR se desideri monitorare i segnali audio digitali AES/EBU di fonti come registratori e console digitali, oppure dei dispositivi analogici come mixer e deck Betacam SP. Puoi monitorare l'audio analogico dei dispositivi di largo consumo, per esempio videoregistratori e lettori DVD, collegando connettori RCA standard. Se preferisci ascoltare l'audio tramite cuffie, inserisci il connettore jack 1/4" nell'apposito ingresso sul pannello frontale.

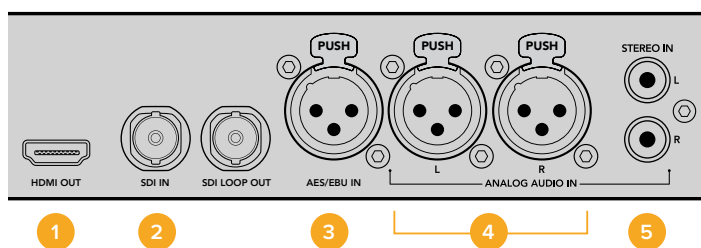

1. HDMI
2. SDI con audio integrato
3. XLR per AES/EBU
4. XLR per audio analogico
5. RCA per connessioni audio standard

Selezionare la fonte audio

Dopo aver collegato la fonte audio a Blackmagic Audio Monitor, premi il pulsante INPUT sul pannello frontale per selezionare il tipo di connessione. Una volta selezionato l'ingresso e rilevato l'audio, gli indicatori di livello a LED si illuminano, confermando il corretto funzionamento dell'ingresso audio. Gli indicatori sono disposti su due file orizzontali, e retroilluminati da LED a colori.

Usa il pulsante INPUT per navigare tra le connessioni audio sul comodo display LCD, dove sono disponibili anche le informazioni relative al tipo di connessione, ai canali audio e al volume. Ora Blackmagic Audio Monitor è pronto per l'uso.

Connettere le uscite video

Sfrutta le uscite video di Blackmagic Audio Monitor per monitorare i segnali video e audio su uno schermo di grandi dimensioni, oppure connettere altra apparecchiatura video.

Le uscite HDMI e SDI di loop consentono il monitoraggio del segnale video con audio integrato.

Tramite un singolo cavo SDI puoi connettere dispositivi di acquisizione SD, HD, 2K e Ultra HD, per esempio DeckLink 4K Extreme. Trasporta il segnale video con audio integrato ai registratori come HyperDeck Studio tramite SD/HD-SDI, oppure ai display più recenti e ai proiettori Ultra HD tramite HDMI.

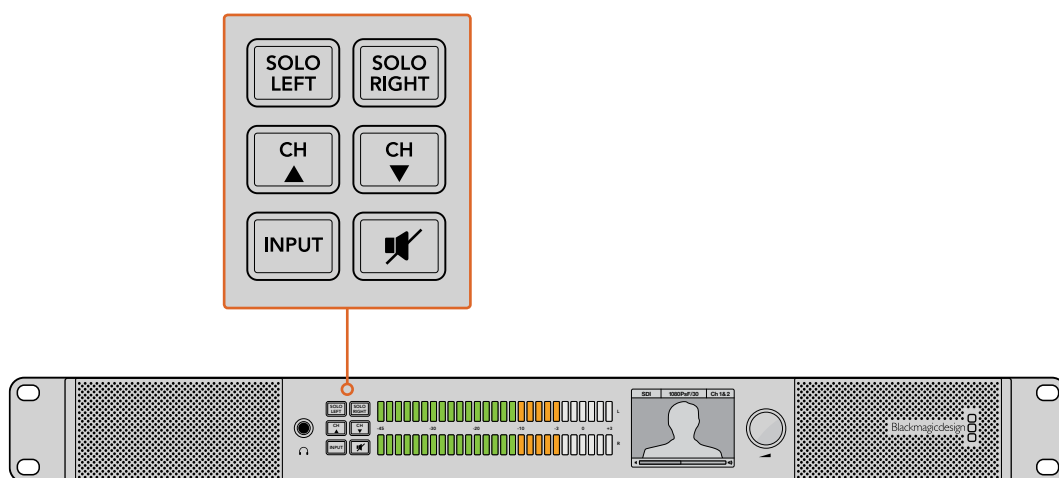

I pulsanti consentono di selezionare l'ingresso che desideri monitorare, isolare i canali di destra o sinistra, spostarti in alto o in basso tra i canali audio e silenziare l'audio degli altoparlanti o delle cuffie.

Utilizzare Blackmagic Audio Monitor

Utilizzare il pannello di controllo

Blackmagic Audio Monitor è dotato di un pannello di controllo che dà accesso rapido alle funzioni principali e alle informazioni di stato.

Display LCD

Il display LCD integrato a colori mostra importanti informazioni sullo stato operativo del dispositivo, per esempio l'ingresso selezionato, il formato video per i segnali SDI, i canali audio selezionati e il livello del volume degli altoparlanti o delle cuffie. Il display LCD segnala anche la presenza di eventuali segnali video SDI. In assenza di segnali video, appare una nota musicale.

A seconda dell'ingresso selezionato il display mostra le seguenti informazioni:

Ingresso SDI

SDI, formato video, canali audio selezionati.

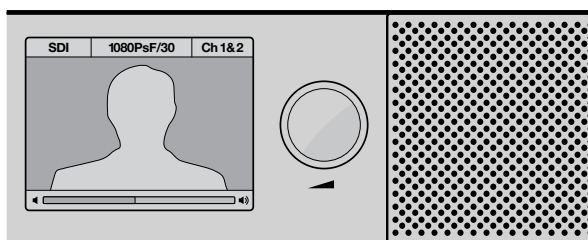

Il display LCD a colori mostra il tipo di connessione, il formato video, i canali audio selezionati e il livello del volume.

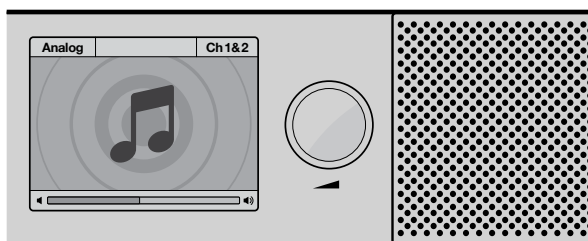

Il display LCD mostra l'icona di una nota musicale. L'icona scompare durante il monitoraggio di un segnale video SDI.

Ingresso XLR con audio AES/EBU bilanciato

AES/EBU, canali audio selezionati.

Ingressi XLR con audio analogico bilanciato

Analogico, canali audio selezionati.

Ingressi RCA con audio analogico non bilanciato

HiFi, canali audio selezionati.

Indicatori di livello

Gli indicatori di livello a LED di Blackmagic Audio Monitor sono disposti su due file orizzontali. I segmenti si illuminano di verde, arancione e rosso per indicare la forza del segnale; se il segnale audio supera la soglia di clipping, tutti i segmenti si illuminano.

La risposta degli indicatori di livello cambia a seconda del tipo di monitoraggio selezionato sull'utilità Audio Monitor Setup. Se hai selezionato l'opzione VU, regola i livelli dell'uscita del dispositivo connesso di modo che non superino la soglia di 0dB indicata sul pannello frontale. Questo accorgimento ottimizza il rapporto segnale/rumore e garantisce la migliore qualità audio. Se i livelli audio superano la soglia di 0dB, tenderà a verificarsi il fenomeno della distorsione sonora.

Consulta la sezione "Utilità Audio Monitor Setup" per installare l'utilità e impostare il tipo di indicatori.

Pulsanti SOLO LEFT e SOLO RIGHT

Questi pulsanti consentono di isolare il canale audio di destra e di sinistra per individuare con facilità eventuali problemi di ogni canale singolarmente.

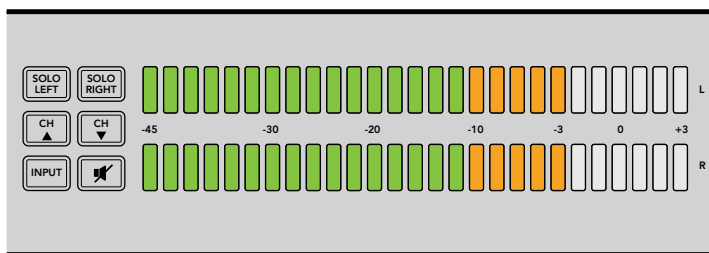

Premi il pulsante SOLO LEFT per disattivare l'audio del canale di destra. Gli indicatori di livello continuano a indicare entrambi i livelli.

Per monitorare il canale audio di sinistra:

- 1 Premi il pulsante SOLO LEFT. Il pulsante si illumina di verde e il suono viene riprodotto solo dall'altoparlante sinistro.
- 2 Premi di nuovo SOLO LEFT per tornare al monitoraggio stereo.

Per monitorare il canale audio di destra:

- 1 Premi il pulsante SOLO RIGHT. Il pulsante si illumina di verde e il suono viene riprodotto solo dall'altoparlante destro.
- 2 Premi di nuovo SOLO RIGHT per tornare al monitoraggio stereo.

Pulsanti canale CH

I due pulsanti CH con freccia in giù e in su consentono di navigare tra i canali audio integrati nella connessione SDI. Per il 3G-SDI, sono presenti fino a 16 canali audio, o 8 coppie di canali. Premi i pulsanti CH per spostarti tra i canali audio integrati nel segnale SDI.

Blackmagic Audio Monitor 12G supporta il 12G-SDI, che integra fino a 64 canali audio, o 32 coppie di canali. Tieni premuto il pulsante CH desiderato per scorrere velocemente le opzioni verso l'alto o verso il basso.

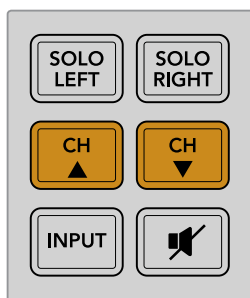

INPUT

Premi ripetutamente il pulsante INPUT per navigare tra gli ingressi SDI, AES/EBU, analogico e HiFi e selezionare la fonte video e audio che desideri monitorare.

L'audio selezionato si può ascoltare mediante gli altoparlanti integrati, e monitorare tramite l'uscita HDMI sui canali 1 e 2.

NOTA L'uscita HDMI mostra una schermata nera quando sono selezionati gli ingressi analogico, AES/EBU, o HiFi. L'uscita di loop SDI invia sempre l'audio e il video connessi all'ingresso SDI.

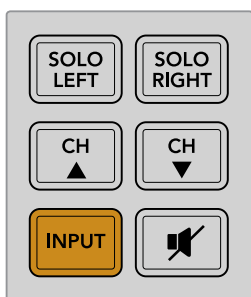

Mute

Premi il pulsante con l'icona dell'altoparlante per silenziare l'audio degli altoparlanti del pannello frontale di Blackmagic Audio Monitor e delle cuffie collegate. L'opzione Mute non intacca l'ingresso audio. Per riattivare l'audio degli altoparlanti o delle cuffie premi di nuovo il pulsante Mute oppure aumenta il volume.

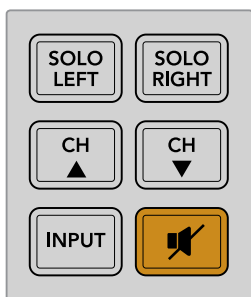

Manopola volume

Ruota la manopola per regolare il volume degli altoparlanti o delle cuffie singolarmente. Il livello del volume appare sul display LCD. Quando sono connesse le cuffie, gli altoparlanti di Blackmagic Audio Monitor si disattivano e l'audio viene riprodotto solo nelle cuffie. Il volume è facilmente regolabile ruotando opportunamente la manopola.

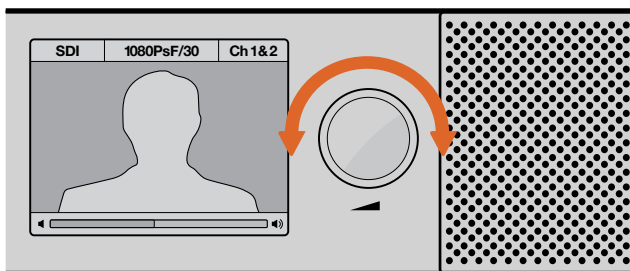

Il display LCD sul pannello di controllo mostra il livello del volume.

Utilità Audio Monitor Setup

Blackmagic Audio Monitor Setup

L'utilità Blackmagic Audio Monitor Setup consente di impostare il tipo di indicatori di livello desiderati, e di aggiornare il software interno di Blackmagic Audio Monitor.

Puoi installare l'utilità con la scheda SD inclusa, ma consigliamo di scaricare la versione più aggiornata dalla pagina Supporto di Blackmagic Design www.blackmagicdesign.com/it/support.

Quando il modello originale di Blackmagic Audio Monitor è connesso al computer tramite USB, puoi cambiarne la configurazione e aggiornare il software interno con l'utilità. Con Blackmagic Audio Monitor 12G è possibile aggiornare l'unità e cambiare la configurazione tramite ethernet, eccetto le impostazioni di rete, per le quali è necessario connettersi tramite USB.

Blackmagic Audio Monitor Setup è compatibile con macOS Mojave 10.14 o successivo, e con Windows 10.

Installazione su macOS

- 1 Fai doppio clic sulla cartella "Installer" dell'utilità o nella cartella "Download" se hai scaricato l'utilità dal sito di Blackmagic Design.
- 2 Segui le istruzioni di installazione. macOS installerà il software automaticamente.

Installazione su Windows

- 1 Fai doppio clic sulla cartella "Installer" dell'utilità o nella cartella "Download" se hai scaricato l'utilità dal sito di Blackmagic Design.
- 2 Segui le istruzioni di installazione e accetta i termini del contratto di licenza. Windows installa il software automaticamente.

Aggiornare il software interno

- 1 Connetti Blackmagic Audio Monitor al tuo computer tramite USB o ethernet.
- 2 Lancia l'utilità Blackmagic Audio Monitor Setup.
- 3 Clicca sull'icona di configurazione. L'utilità suggerisce di aggiornare il software se rileva una versione precedente.
- 4 Clicca su "Update" per avviare l'installazione dell'aggiornamento.



Clicca su "Update" per aggiornare il software interno.

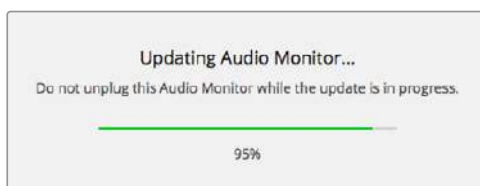

La barra di avanzamento mostra lo stato dell'aggiornamento in corso.

- 5 Clicca su “Close” ad aggiornamento completato.



Aggiorna il software interno di Blackmagic Audio Monitor e cambia le impostazioni con l'utilità Blackmagic Audio Monitor Setup.

La tab Meter

Lancia l'utilità e clicca sull'icona di configurazione per accedere alle impostazioni degli indicatori di livello. Le opzioni disponibili sono VU, PPM e Loudness, con scale EBU e BBC. Gli indicatori VU sono già conformi agli standard, mentre PPM e Loudness offrono un sistema di misurazione della percezione dell'intensità. La tabella seguente elenca i tipi di indicatori di livello e le scale di misurazione ad essi corrispondenti.

Tipo di indicatore	Tipo di scala	Scala	Riferimento per l'uso
VU	–	-45 a +3	Stampato sul pannello
PPM	EBU	-12 a +12	Adesivo
PPM	BBC	1 a 7	Adesivo
Loudness	EBU +9	-18 a +9	Adesivo
Loudness	EBU +18	-36 a +18	Adesivo
Loudness	Piena scala +9	-41 a -14	Adesivo
Loudness	Piena scala +18	-59 a -5	Adesivo

VU

Questo tipo di indicatore misura la media tra i brevi picchi e le valli del segnale audio. Serve principalmente per monitorare i picchi del segnale, ma grazie alla sua capacità di mediare è utile anche per monitorare il loudness percepito dell'audio.

PPM

Avvalendosi della funzione “peak hold”, questo indicatore ritiene momentaneamente i picchi del segnale e un tempo di caduta lento, segnalando chiaramente il livello in cui l'audio raggiunge il suo picco.

Loudness

Questo indicatore segnala la qualità soggettiva del loudness del segnale audio. Gli odierni standard del broadcast prevedono la misurazione del loudness per ottenere livelli di loudness costanti.

Gli indicatori VU e PPM permettono di selezionare un livello di riferimento di -18dB o -20dB, a seconda degli standard del broadcast dei diversi Paesi.

I LED di Blackmagic Audio Monitor si illuminano in modo diverso a seconda del tipo di indicatore di livello selezionato. Per identificare il picco del segnale audio con facilità, il prodotto include anche strisce adesive che riportano accurate scale dB di riferimento. Stacca l'adesivo con la scala desiderata e applicalo tra le due file di indicatori a LED, sopra gli indici VU esistenti sul pannello frontale.

Sono inclusi due adesivi per ogni tipo di indicatore di livello e scala. Gli adesivi sono anche disponibili presso gli uffici Blackmagic Design di supporto. Visita il sito Blackmagic Design alla pagina di supporto www.blackmagicdesign.com/it/support per trovare l'ufficio più vicino.



Seleziona il tipo di indicatore di livello spuntando la casella desiderata e clicca su "Save".

EBU PPM									
-12	-8	-4	0	+4	+8	+12			
-12	-8	-4	0	+4	+8	+12			
BBC PPM									
1	2	3	4	5	6	7			
1	2	3	4	5	6	7			
Loudness Units EBU +9dB									
-18	-15	-12	-9	-6	-3	0	+3	+6	+9
-18	-15	-12	-9	-6	-3	0	+3	+6	+9
Loudness Units Fullscale +9dB									
-41	-38	-35	-32	-29	-26	-23	-20	-17	-14
-41	-38	-35	-32	-29	-26	-23	-20	-17	-14
Loudness Units EBU +18dB									
-36	-30	-24	-18	-12	-6	0	+6	+12	+18
-36	-30	-24	-18	-12	-6	0	+6	+12	+18
Loudness Units Fullscale +18dB									
-59	-53	-47	-41	-35	-29	-23	-17	-11	-5
-59	-53	-47	-41	-35	-29	-23	-17	-11	-5

Le strisce adesive incluse consentono di individuare con facilità il picco del segnale audio in base al tipo di indicatore di livello selezionato.

La tab Configure

Blackmagic Audio Monitor 12G include una tab di configurazione aggiuntiva che contiene la versione del software e le impostazioni di rete del dispositivo. Puoi assegnare un nome all'unità, per renderla facilmente riconoscibile quando ci si connette in modalità remota.

Assegnare un nome a Blackmagic Audio Monitor 12G

Per assegnare un nome a Blackmagic Audio Monitor 12G:

- 1 Clicca sulla tab "Configure".
- 2 Nel menù "Details" clicca sul campo "Name" e digita il nome che desideri assegnare al dispositivo.
- 3 Clicca su "Save".



Cambiare le impostazioni di rete

Accedere a Blackmagic Audio Monitor 12G in rete è il metodo più immediato quando si controllano più unità. Basta utilizzare Blackmagic Audio Monitor Setup. Blackmagic Audio Monitor 12G acquisisce automaticamente un indirizzo di rete, ed è facile selezionarlo dalla schermata impostazioni della home.

Se Blackmagic Audio Monitor 12G non viene rilevato, o se lo hai precedentemente impostato su un indirizzo statico incompatibile con la rete in uso, potrebbe essere necessario cambiare le impostazioni di rete a livello locale. Per farlo connetti il dispositivo tramite USB.

Cambiare le impostazioni di rete tramite USB

Connetti Blackmagic Audio Monitor 12G con un cavo USB a un computer con installata l'utilità Blackmagic Audio Monitor Setup. La porta USB si trova sul retro di Blackmagic Audio Monitor 12G. Una volta connesso il dispositivo al computer, seleziona Audio Monitor 12G sulla home dell'utilità, e clicca sulla tab "Configure". Qui puoi scegliere tra un indirizzo di rete statico o dinamico. Se selezioni un IP statico, puoi configurare manualmente l'indirizzo IP, la maschera di sottorete, e il gateway.

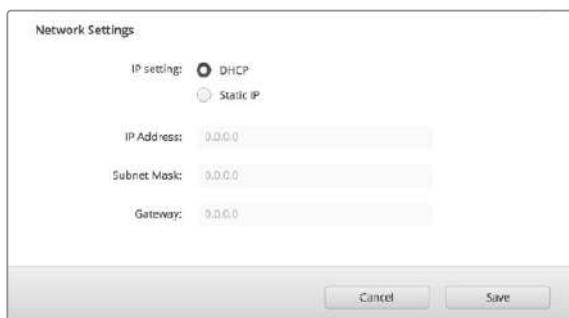

Installare il modulo opzionale Blackmagic Dolby® Decoder Module

Dolby ha sospeso la produzione del modulo di decodifica. Tuttavia se ne possiedi uno per il modello Blackmagic Audio Monitor originale e desideri installarlo, segui le istruzioni riportate sotto.

NOTA Blackmagic Audio Monitor 12G non supporta il modulo opzionale Blackmagic Dolby Decoder Module.

AVVERTENZE

Assicurati di aver scollegato Blackmagic Audio Monitor dalla corrente prima di installare il modulo di decodifica Dolby, perché è necessario rimuovere il coperchio della chassis per accedere alla scheda madre. È pertanto necessario che questa operazione venga effettuata da personale qualificato. Inoltre consigliamo di prendere le necessarie precauzioni per ridurre il rischio di scosse elettriche.

Installare il modulo

Installando il modulo di decodifica Blackmagic Dolby è possibile monitorare audio Dolby Digital e Dolby E, impiegati nelle odierne produzioni cinematografiche e televisive. Dolby 5.1 surround si codifica mediante i canali frontali (destra e sinistra), i canali surround posteriori (destra e sinistra), un canale centrale e un canale per le basse frequenze.

Il decodificatore Dolby è un modulo a 72 pin, facilmente installabile nello slot SIMM della scheda madre di Blackmagic Audio Monitor.

Per installare il modulo di decodifica Dolby di Blackmagic:

- 1 Assicurati che il dispositivo sia scollegato.
- 2 Estrai le 21 viti del coperchio protettivo con un cacciavite a croce. Rimuovi il coperchio.
- 3 Posiziona il modulo di decodifica Blackmagic Dolby con i contatti rivolti verso lo slot SIMM vuoto. Allinea la fessura del modulo con l'apertura dello slot per inserirlo correttamente.
- 4 Inserisci delicatamente il modulo nello slot SIMM fino a bloccarlo in posizione.
- 5 Inclina il modulo verso la parte posteriore di Blackmagic Audio Monitor fino a che le linguette metalliche si saldino a entrambi i lati del modulo.
- 6 Riponi il coperchio avvitando le 21 viti precedentemente estratte.

Dopo aver installato il modulo Blackmagic Dolby, attacca l'adesivo Dolby fornito sul retro del pannello accanto al segnale di pericolo per indicare che il modulo è stato installato.

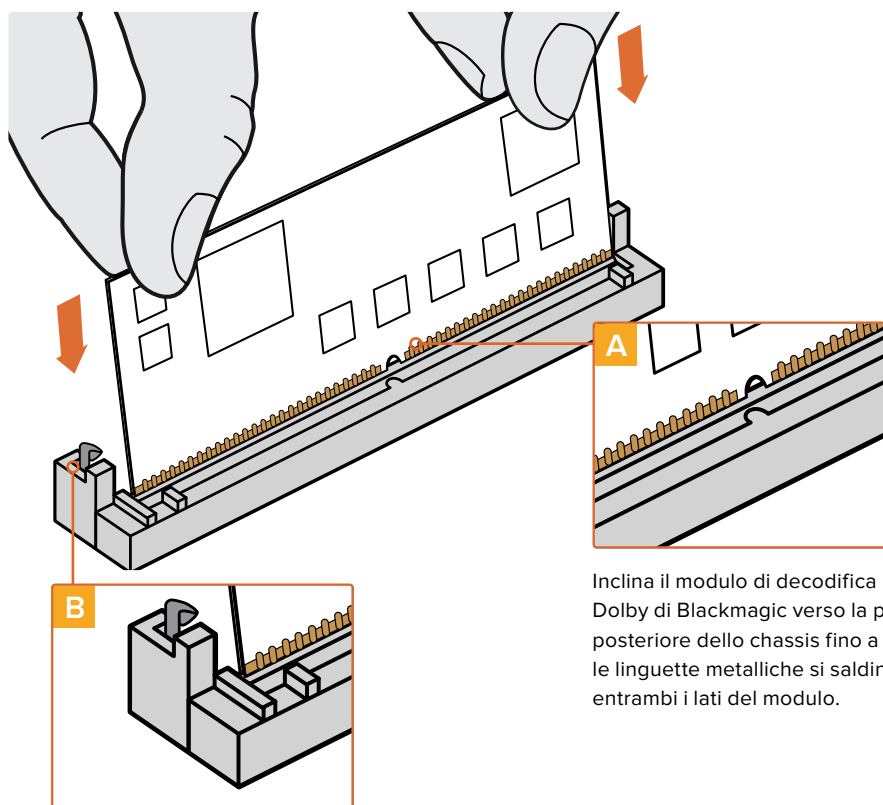

Inclina il modulo di decodifica Dolby di Blackmagic verso la parte posteriore dello chassis fino a che le linguette metalliche si saldino a entrambi i lati del modulo.

Solleva il modulo di decodifica Dolby di Blackmagic dagli angoli e allinea la fessura con lo slot SIMM. Inseriscilo fino a bloccarlo in posizione.

Confermare l'audio Dolby

Quando Blackmagic Audio Monitor rileva un segnale di audio Dolby decodificato, il logo Dolby appare nell'angolo in alto a destra del display LCD. È possibile monitorare 4 coppie di canali di Dolby surround premendo opportunamente i due pulsanti CH sul pannello di controllo.

Developer Information

Controlling Blackmagic Audio Monitor 12G using Telnet

The Blackmagic Audio Monitor 12G Ethernet Protocol gives you the freedom to build your own custom control solutions for your Blackmagic Audio Monitor 12G. For example, you can create your own software application or web interface to control your Blackmagic Audio Monitor 12G via Ethernet from your computer.

The first step is to connect your Blackmagic Audio Monitor 12G to your computer via Ethernet. You can do this by connecting to the same network your computer is connected to, or you can connect Blackmagic Audio Monitor 12G directly to your computer.

NOTE If Blackmagic Audio Monitor 12G is connected directly to your computer, set your computer to a manual static IP address. Set the first three blocks of numbers in the IP address to match your Blackmagic Audio Monitor 12G and set the subnet mask to 255.255.255.0. You can leave the gateway or router setting blank as it will not be used in a direct connection between your computer and Blackmagic Audio Monitor 12G.

If your network settings are set correctly, you can now open the Terminal application on macOS, or enable Telnet command line utilities on Windows and enter Blackmagic Audio Monitor 12G Ethernet Protocol commands. These commands can be programmed into your application and triggered by related items on a custom user interface of your own design.

Using Telnet on macOS and Windows

- 1 On macOS, open the Terminal application which is located within the Applications > Utilities folder.

To open the command prompt in Windows, click on the 'start' menu and type 'cmd' in the search bar. Press 'enter'.

- 2 Type in "telnet" and a space followed by the IP address of your computer, then another space and "9996", which is the default port number for Blackmagic Audio Monitor 12G.

For example:

```
telnet 192.168.25.253 9996
```

Press 'enter'. The Protocol Preamble screen will appear.

Blackmagic Audio Monitor 12G Ethernet Protocol V1.0

Summary

The Blackmagic Audio Monitor 12G Ethernet Protocol is a text based protocol that is accessed by connecting to TCP port 9996 on a Blackmagic Audio Monitor 12G.

The Blackmagic Audio Monitor 12G sends information in blocks which each have an identifying header in all-caps, followed by a full-colon. A block spans multiple lines and is terminated by a blank line.

Each line in the protocol is terminated by a new line character.

Upon connection, the Blackmagic Audio Monitor 12G sends a complete dump of the state of the device. After the initial status dump, status updates are sent every time the Blackmagic Audio Monitor 12G status changes.

To be resilient to future protocol changes, clients should ignore blocks they do not recognize, up to the trailing blank line. Within existing blocks, clients should ignore lines they do not recognize.

Legend

↵ line feed or carriage return
... and so on

Version 1.0 of the Blackmagic Audio Monitor 12G Ethernet Protocol was released with Blackmagic Audio Monitor 12G 3.0 software.

Protocol Preamble

The first block sent by the Blackmagic Audio Monitor 12G is always the protocol preamble:

```
PROTOCOL PREAMBLE:  
Version: 1.0
```

The version field indicates the protocol version. When the protocol is changed in a compatible way, the minor version number will be updated. If incompatible changes are made, the major version number will be updated.

Device Information

The next block contains general information about the connected Blackmagic Audio Monitor 12G device. If a device is connected, the Blackmagic Audio Monitor 12G will report the attributes of the Blackmagic Audio Monitor 12G:

```
AUDIOMONITOR DEVICE:↵  
Model: Blackmagic Audio Monitor 12G  
Label: Blackmagic Audio Monitor 12G
```

Only the label can be modified.

```
AUDIOMONITOR DEVICE:↵  
Label: My new name↵  
↵
```

The response will be

```
ACK:  
AUDIOMONITOR DEVICE:  
Label: My new name
```

The next block will show the network settings which can only be changed via the Blackmagic Audio Monitor Setup utility when connected over USB. This is for information only.

```
NETWORK:  
Dynamic IP: 1  
Current address: 0.0.0.0  
Current subnet: 0.0.0.0  
Current gateway: 0.0.0.0
```

The next block is the meter type.

```
AUDIO METER:  
Meter Mode: VU (-20dBFS Ref)
```

This can be changed to VU (-20dBFS Ref), VU (-18dBFS Ref), PPM EBU (-20dBFS Ref), PPM EBU (-18dBFS Ref), PPM BBC (-20dBFS Ref), PPM BBC (-18dBFS Ref), Loudness (EBU +9 scale) or Loudness (EBU +18 scale)

```
AUDIO METER:↵  
Meter Mode: Loudness (EBU +18 scale)↵  
↵
```

The response will be

```
ACK:  
AUDIO METER:  
Meter Mode: Loudness (EBU +18 scale)
```

The next block is the input type.

```
AUDIO INPUT:  
Routing: Speaker Stereo SDI Stereo 1-2
```

This can be changed to SDI Stereo 3-4, SDI Stereo 5-6, SDI Stereo 7-8, SDI Stereo 9-10, SDI Stereo 11-12, SDI Stereo 13-14, SDI Stereo 15-16, XLR AES/EBU Stereo 1-2, XLR Analog Stereo or RCA Stereo

```
AUDIO INPUT:↵  
Routing: Speaker Stereo XLR AES/EBU Stereo 1-2↵  
↵
```

The response will be

```
ACK:  
AUDIO INPUT:  
Routing: Speaker Stereo XLR AES/EBU Stereo 1-2
```

The next block is the audio output state. This indicates the current headphone and speaker volume settings as well as the state of the mute and solo buttons.

```
AUDIO OUTPUT:  
Gain: Speaker Stereo 0  
Gain: Headphone Stereo 0  
Mute: false  
Solo: Off
```

The volume gain settings can be set between 0 and 255. Mute can be true or false and Solo can be Off, Left or Right

```
AUDIO OUTPUT:↵  
Gain: Speaker Stereo 125↵  
Solo: Right↵  
↵
```

The response will be

```
ACK:  
AUDIO OUTPUT:  
Gain: Speaker Stereo 125  
Solo: Right
```

Checking the Connection

While the connection to the Blackmagic Audio Monitor 12G is established, a client may send a special no-operation command to check that the Blackmagic Audio Monitor 12G is still responding:

```
PING:↵  
↵
```

If the Blackmagic Audio Monitor 12G is responding, it will respond with an ACK message as for any other recognized command.

Checking valid Protocol Commands

While the connection to the Blackmagic Audio Monitor 12G is established, a client may send a special HELP command to obtain a list of supported Telnet commands:

```
HELP:↵  
↵  
AUDIOMONITOR DEVICE:  
Model: <label> [read only]  
Label: <label>  
Unique ID: <label> [read only]  
  
NETWORK:  
Dynamic IP: <boolean> [read only]  
Current address: <IP_address> [read only]  
Current subnet: <IP_address> [read only]  
Current gateway: <IP_address> [read only]  
  
AUDIO METER:  
Meter Mode: <enum> -> <enum> = <"VU (-20dBFS Ref)" | "VU (-18dBFS Ref)" |  
"PPM EBU (-20dBFS Ref)" | "PPM EBU (-18dBFS Ref)" | "PPM BBC (-20dBFS Ref)"  
| "PPM BBC (-18dBFS Ref)" | "Loudness (EBU +9 scale)" | "Loudness (EBU  
+18 scale)">;  
  
AUDIO INPUT:  
Routing: <enum1> <enum2> -> <enum1> = <"Speaker Stereo">; <enum2> = <"SDI  
Stereo 1-2" | "SDI Stereo 3-4" | "SDI Stereo 5-6" | "SDI Stereo 7-8" | "SDI  
Stereo 9-10" | "SDI Stereo 11-12" | "SDI Stereo 13-14" | "SDI Stereo 15-16" |  
"XLR AES/EBU Stereo 1-2" | "XLR Analog Stereo" | "RCA Stereo">;  
  
AUDIO OUTPUT:  
Gain: <enum> <integer> -> <enum> = <"Speaker Stereo" | "Headphone Stereo">;  
<integer> = <0..255>;  
  
Mute: <boolean> -> <boolean> = <true | false>;  
  
Solo: <enum> -> <enum> = <"Off" | "Left" | "Right">;
```

Assistenza

Assistenza clienti

Per ottenere supporto tecnico e non solo, visita la pagina Supporto del sito Blackmagic Design.

Pagina di supporto online di Blackmagic Design

Per il materiale più recente, inclusi software e note di supporto, visita il sito Blackmagic Design alla pagina www.blackmagicdesign.com/it/support

Il Forum Blackmagic Design

La pagina Forum del nostro sito Blackmagic Design è un'ottima risorsa per ottenere informazioni utili e condividere idee creative. Qui troverai le risposte alle domande più frequenti, oltre ai consigli degli utenti esistenti e dello staff Blackmagic Design. Visita la pagina Forum su <https://forum.blackmagicdesign.com>

Contatta Blackmagic Design

Se il materiale sulla nostra pagina Forum non risponde alle tue domande, clicca su “Invia una email” nella pagina Supporto, oppure clicca su “Trova un team di supporto” per contattare direttamente il team di Blackmagic Design più vicino a te.

Verificare la versione del software

Per scoprire la versione del software Blackmagic Audio Monitor installata sul tuo computer, apri la tab “About Blackmagic Audio Monitor Setup”.

- Su macOS, apri Blackmagic Audio Monitor Setup dalla cartella Applicazioni e seleziona “About Blackmagic Audio Monitor Setup” dal menù.
- Su Windows 10, clicca l'icona Blackmagic Audio Monitor Setup nella pagina Start. Dal menù “Help” clicca su “About Blackmagic Audio Monitor Setup”.

Dove trovare gli aggiornamenti più recenti del software

Gli ultimi aggiornamenti software sono disponibili sul sito Blackmagic Design alla pagina Supporto www.blackmagicdesign.com/it/support. Ti consigliamo di non aggiornare il software se sei nel mezzo di un progetto importante.

Normative

Smaltimento di apparecchiature elettriche ed elettroniche nell'Unione Europea



Questo simbolo indica che il dispositivo non deve essere scartato insieme agli altri rifiuti, ma consegnato a uno degli appositi centri di raccolta e riciclaggio. La raccolta e lo smaltimento differenziato corretto di questo tipo di apparecchiatura evita lo spreco di risorse e contribuisce alla sostenibilità ambientale e umana. Per tutte le informazioni sui centri di raccolta e riciclaggio, contatta gli uffici del tuo comune di residenza o il punto vendita presso cui hai acquistato il prodotto.



Questo dispositivo è stato testato e dichiarato conforme ai limiti relativi ai dispositivi digitali di Classe A, come indicato nella Parte 15 del regolamento FCC. Tali limiti sono stati stabiliti con lo scopo di fornire protezione ragionevole da interferenze dannose in ambienti commerciali. Questo dispositivo genera, usa e può irradiare energia a radiofrequenza e, se non è installato o usato in conformità alle istruzioni, può causare interferenze dannose che compromettono le comunicazioni radio. Operare questo dispositivo in ambienti residenziali può causare interferenze dannose, nella cui evenienza l'utente dovrà porvi rimedio a proprie spese.

Il funzionamento è soggetto alle due condizioni seguenti:

- 1 Questo dispositivo non deve causare interferenze dannose.
- 2 Questo dispositivo deve accettare eventuali interferenze ricevute, incluse le interferenze che possono causare un funzionamento indesiderato.

Dichiarazione ISED (Canada)

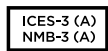

Questo dispositivo è conforme agli standard canadesi sui dispositivi digitali di Classe A.

Qualsiasi modifica o utilizzo del dispositivo al di fuori di quello previsto potrebbero invalidare la conformità a tali standard.

Consigliamo di connettere le interfacce HDMI usando cavi schermati HDMI di alta qualità.

Questo dispositivo è stato testato per l'uso in ambienti commerciali. Se utilizzato in ambienti domestici, può causare interferenze radio.

Sicurezza

Per evitare scosse elettriche, connettere il dispositivo a una presa di corrente con messa a terra. Per qualsiasi dubbio, contattare un elettricista qualificato.

Per ridurre il rischio di scosse elettriche, evitare di esporre il dispositivo a gocce o spruzzi.

Questo dispositivo è adatto all'uso nei luoghi tropicali con una temperatura ambiente non superiore ai 40°C.

Lasciare uno spazio adeguato intorno al dispositivo per consentire sufficiente ventilazione.

Se installato su rack, assicurarsi che i dispositivi adiacenti non ostacolino la ventilazione.

Le parti all'interno del dispositivo non sono riparabili dall'utente. Contattare un centro assistenza Blackmagic Design per le operazioni di manutenzione.



Usare il dispositivo a un'altitudine non superiore a 2000 m sopra il livello del mare.

Dichiarazione dello Stato della California

Questo dispositivo può esporre l'utente a sostanze chimiche, per esempio tracce di bifenili polibromurati nelle parti in plastica, che nello Stato della California sono considerati causa di cancro e di difetti alla nascita o di altri difetti riproduttivi.

Per maggiori informazioni, visitare la pagina www.P65Warnings.ca.gov.

Garanzia

Garanzia limitata di un anno

Blackmagic Design garantisce che questo prodotto è fornito privo di difetti nei materiali e nella manifattura per un periodo di un anno a partire dalla data d'acquisto. Durante il periodo di garanzia Blackmagic Design riparerà o, a sua scelta, sostituirà tutti i componenti che risultino difettosi esonerando il Cliente da costi aggiuntivi, purché questi vengano restituiti dal Cliente.

Per ottenere l'assistenza coperta dalla presente garanzia, il Cliente deve notificare Blackmagic Design del difetto entro il periodo di garanzia. Il Cliente è responsabile del costo di imballaggio e di spedizione del prodotto al centro di assistenza indicato da Blackmagic Design, con spese di spedizione prepagate. Il costo include spedizione, assicurazione, tasse, dogana, e altre spese pertinenti alla resa del prodotto a Blackmagic Design.

Questa garanzia perde di validità per danni causati da utilizzo improprio, o da manutenzione e cura inadeguate del prodotto. Blackmagic Design non ha obbligo di assistenza e riparazione sotto garanzia per danni al prodotto risultanti da: a) precedenti tentativi di installazione, riparazione o manutenzione da personale non autorizzato, ovvero al di fuori del personale Blackmagic Design, b) precedenti usi impropri o tentativi di connessione ad attrezzatura incompatibile al prodotto, c) precedente uso di parti o ricambi non originali Blackmagic Design, o d) precedenti modifiche o integrazione del prodotto ad altri prodotti, con il risultato di rendere la riparazione più difficoltosa o di allungare le tempistiche di eventuali ispezioni atte alla riparazione. La presente garanzia di Blackmagic Design sostituisce qualsiasi altra garanzia, esplicita o implicita. Blackmagic Design e i suoi fornitori escludono qualsiasi altra garanzia implicita di commerciabilità o di idoneità ad un uso specifico. L'intera responsabilità di Blackmagic Design e l'unico esclusivo ricorso dell'utente per qualsiasi danno arrecato di natura indiretta, specifica, accidentale o consequenziale, anche qualora Blackmagic Design fosse stata avvertita della possibilità di tali danni, è la riparazione o la sostituzione dei prodotti difettosi. Blackmagic Design non si assume alcuna responsabilità per qualsiasi uso illegale del dispositivo da parte del Cliente. Blackmagic Design non si assume alcuna responsabilità per danni derivanti dall'uso di questo prodotto. Il Cliente utilizza questo prodotto a proprio rischio.

© Copyright 2020 Blackmagic Design. Tutti i diritti riservati. 'Blackmagic Design', 'DeckLink', 'HDLink', 'Workgroup Videohub', 'Multibridge Pro', 'Multibridge Extreme', 'Intensity' e 'Leading the creative video revolution' sono marchi registrati negli Stati Uniti e in altri Paesi. Altri nomi di prodotti e aziende menzionati in questo manuale potrebbero essere marchi dei rispettivi proprietari.



Manual de Instalação e Operação

Blackmagic Audio Monitor 12G

Janeiro 2020

Português



Bem-vindo

Obrigado por adquirir um Blackmagic Audio Monitor para a sua produção.

Esperamos que você compartilhe do nosso sonho de transformar a indústria televisiva em uma indústria verdadeiramente criativa, permitindo que todos tenham acesso a equipamentos de vídeo da mais alta qualidade.

O monitoramento de áudio é algo crucial para qualquer fluxo de trabalho de produção de vídeo, independentemente de ser broadcast, pós-produção ou produção ao vivo.

O Blackmagic Audio Monitor inclui todos os recursos de monitores de áudio profissionais em um design com montagem em rack compacto. Você pode conectar praticamente todos os tipos de equipamentos de áudio para monitoramento de alta qualidade. O Blackmagic Audio Monitor original é compatível com 6G-SDI para conexão de vídeos Ultra HD de até 30 quadros por segundo. Já o Blackmagic Audio Monitor 12G é compatível com 12G-SDI para conexão de vídeos Ultra HD de até 60 quadros por segundo, assim como com entradas de sinal de vídeo 3G-SDI nível A e B.

Este manual de instrução contém todas as informações necessárias para você começar a usar o seu Blackmagic Audio Monitor.

Por favor, consulte a página de suporte no nosso site em www.blackmagicdesign.com/br para a versão mais recente deste manual e para atualizações do software interno do seu Blackmagic Audio Monitor. Para garantir o recebimento de todos os recursos mais recentes, mantenha o seu software atualizado. Ao baixar o software, registre seus dados para que possamos mantê-lo informado sobre os novos lançamentos. Estamos sempre trabalhando com novos recursos e aprimoramentos, então gostaríamos muito de ouvir a sua opinião!

Grant Petty

Diretor Executivo da Blackmagic Design

Índice

Blackmagic Audio Monitor 12G

Instruções Preliminares	203
Blackmagic Audio Monitor	203
Conectar Áudio	203
Selecionar Sua Fonte de Áudio	204
Conectar Saídas de Vídeo	204
Usar Blackmagic Audio Monitor	205
Usar Painel de Controle	205
LCD	205
Medidores de Nível de Áudio	205
Botões Solo Left e Solo Right	206
Channel Up e Channel Down	206
Botão Input	207
Botão Silenciar	207
Volume	207
Configurar Monitor de Áudio	208
Blackmagic Audio Monitor Setup	208
Instalar no macOS	208
Instalar no Windows	208
Atualizar Software Interno	208
Aba Meter	209
Aba Configure	211
Alterar Configurações de Rede	211
Instalar Módulo Decodificador Blackmagic Dolby® Opcional	212
Instalar Módulo	212
Confirmar Dolby Audio	213
Informações para Desenvolvedores	214
Controlar Blackmagic Audio Monitor 12G usando Telnet	214
Blackmagic Audio Monitor 12G Ethernet Protocol V1.0	214
Ajuda	218
Informações Regulatórias	219
Informações de Segurança	220
Garantia	221

Instruções Preliminares

Blackmagic Audio Monitor

O Blackmagic Audio Monitor e o Blackmagic Audio Monitor 12G oferecem soluções de monitoramento de áudio em tempo real montáveis em rack que podem ser usadas com uma variedade de fontes de áudio e vídeo em ambientes ao vivo, pós-produções e transmissões.

O Blackmagic Audio Monitor conecta-se a equipamentos de áudio analógico e digital AES/EBU e SD/HD/3G/6G-SDI para garantir que as saídas tenham os níveis de áudio corretos. O modelo 12G é compatível com 12G-SDI, portanto é possível conectar vídeos Ultra HD de até 60 quadros por segundo. Os medidores de nível em LED dos canais da direita e esquerda permitem que você acompanhe o pico do seu áudio e o LCD exibe a sua entrada de vídeo SDI, além de informações importantes, como tipo de conexão de entrada, formato de vídeo, taxa de quadro, canais de áudio e nível de volume.

É possível monitorar até 16 canais de áudio SDI embutido ou usar conectores XLR para áudio analógico balanceado e digital AES/EBU. Também há conectores RCA para que você possa conectar equipamentos de uso doméstico, como sistemas HiFi e iPods.

O seu Blackmagic Audio Monitor inclui dois alto-falantes internos de alcance completo e alta qualidade e dois subwoofers que fornecem frequências em ampla variedade para a reprodução de som profundo e claro. Alternativamente, você pode conectar um fone de ouvido para um monitoramento sonoro seguro, que é excelente para ambientes ruidosos.



Painel frontal do Blackmagic Audio Monitor 12G.



Painel traseiro do Blackmagic Audio Monitor 12G.

Conectar Áudio

O Blackmagic Audio Monitor é compatível com praticamente todos os tipos de equipamentos de áudio. Caso queira conectar sinais SDI em SD, HD, 2K ou até Ultra HD, você pode usar a entrada SDI com um conector BNC padrão. O modelo 12G é compatível com entradas de sinal de vídeo 3G-SDI nível A e B.

Você deve usar conectores XLR caso deseje monitorar áudio digital AES/EBU a partir de equipamentos incluindo gravadores de disco e consoles de áudio digital ou de equipamentos como mesas de som e decks Betacam SP. Áudios analógicos de equipamentos de uso doméstico, como aparelhos de DVD e VCRs, podem ser conectados usando conectores RCA padrão. Outra opção é conectar fones de ouvido através do conector tipo jack para fone de ouvido TRS de 1/4", quando precisar ouvir seu áudio sem perturbar a equipe.

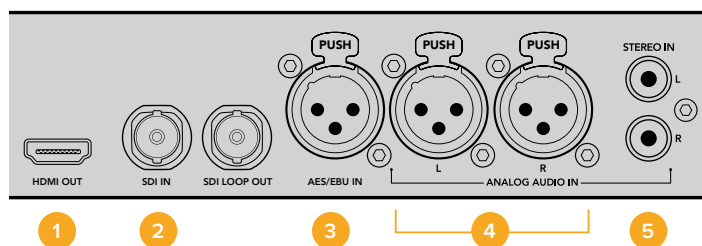

1. HDMI 2. Áudio SDI embutido 3. XLR para AES/EBU
4. XLR para áudio analógico 5. RCA para conexões de áudio de uso doméstico

Selecionar Sua Fonte de Áudio

Após conectar seu equipamento de áudio ao Blackmagic Audio Monitor, basta selecionar sua conexão pressionando o botão “Input” no painel de controle. Com sua entrada selecionada e o áudio presente, você notará que a iluminação em LED dos medidores de nível de áudio fica acesa. O medidor de nível de áudio consiste em 2 fileiras de LEDs coloridas e ficam acesas para que você confirme com facilidade se sua entrada de áudio está funcionando.

O botão “Input” permite que você navegue pelas conexões de áudio e você pode vê-las no LCD com informações incluindo tipo de entrada, canais de áudio e nível de volume. Isto é tudo que você precisa fazer para monitorar áudio com o Blackmagic Audio Monitor.

Conectar Saídas de Vídeo

Caso você precise de monitoramento de vídeo, assim como de áudio, as saídas de vídeo do Blackmagic Audio Monitor permitem que você monitore vídeo com áudio em uma tela grande, ou conecte outros equipamentos de vídeo.

A saída HDMI e a saída loop SDI podem ser usadas para monitorar vídeo e áudio embutido. Você pode conectar SD, HD, 2K e até dispositivos de captação Ultra HD, como DeckLink 4K Extreme com um único cabo SDI. Conecte vídeo com áudio embutido a decks de gravação, como HyperDeck Studio, via SD/HD-SDI ou monitores Ultra HD mais modernos e projetores HDMI.

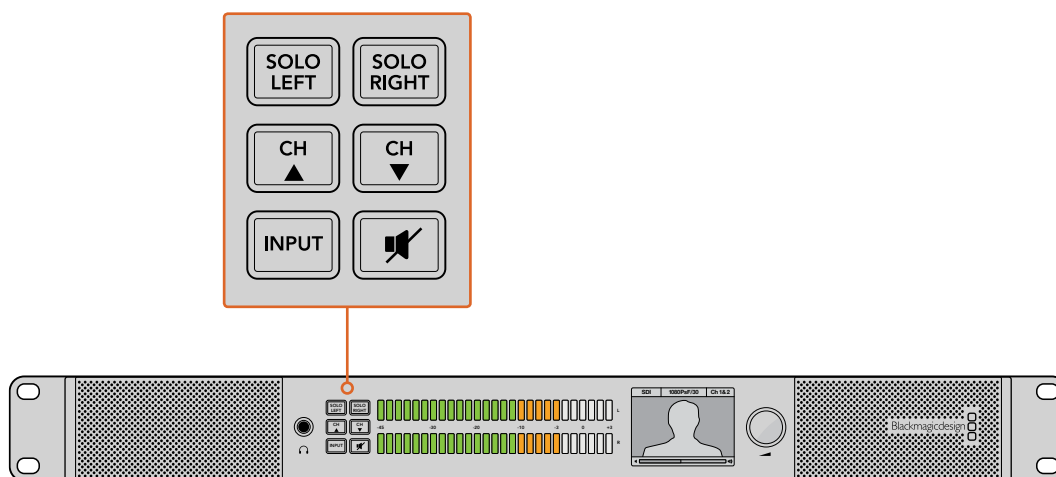

Os botões de seleção permitem escolher a entrada que deseja monitorar, isolar canais estéreo da direita e esquerda, navegar para cima e para baixo pelos canais de áudio disponíveis e silenciar os alto-falantes ou fones de ouvido.

Usar Blackmagic Audio Monitor

Usar Painel de Controle

O painel de controle do Blackmagic Audio Monitor fornece acesso rápido às funções e indicadores de status mais importantes.

LCD

O LCD colorido integrado possui sobreposições de texto que exibem informações de status importantes, como a entrada selecionada, o formato de vídeo caso SDI esteja conectado, os canais de áudio selecionados e o volume dos alto-falantes ou fones de ouvido. O LCD também exibirá quaisquer sinais de entrada de vídeo SDI. Caso nenhum vídeo SDI seja detectado, um ícone de música será exibido.

As seguintes informações serão exibidas para cada entrada selecionada:

Entrada SDI

SDI, formato de vídeo e canais de áudio selecionados.

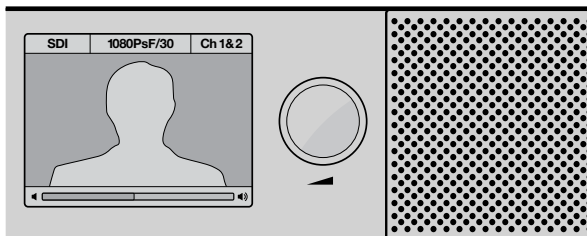

O LCD colorido exibe informações de áudio de vídeo, incluindo tipo de conexão, formato de vídeo, canais de áudio selecionados e nível de volume.

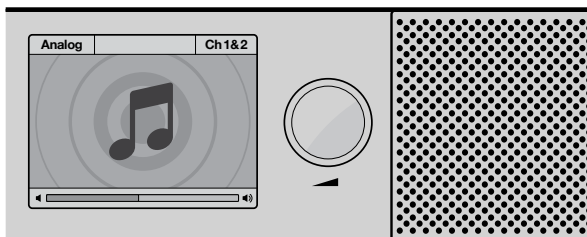

Um ícone de música será exibido no LCD exceto quando um sinal de vídeo SDI estiver sendo monitorado.

Entrada XLR de áudio AES/EBU balanceado

AES/EBU, canais de áudio selecionados.

Entradas XLR de áudio analógico balanceado

Analógico, canais de áudio selecionados.

Entradas RCA de áudio analógico não balanceado

HiFi, canais de áudio selecionados.

Medidores de Nível de Áudio

Os medidores de nível do Blackmagic Audio Monitor possuem duas fileiras de LEDs verdes, laranjas e vermelhos, que indicam a potência dos seus níveis de áudio. Se todos os LEDs estiverem acesos, significa que os níveis de áudio estão altos demais e sendo saturados.

O comportamento dos medidores de nível de áudio mudará de acordo com a configuração do tipo de medidor que você selecionou no utilitário Audio Monitor Setup. Caso esteja usando medição VU, ajuste os níveis de saída no seu equipamento de áudio de modo que o pico do medidor ocorra no indicador 0dB do painel de controle. Isto maximiza a proporção sinal/ruído e garante que o seu áudio possua a melhor qualidade possível. Caso seu áudio atinja o pico além do indicador 0dB, o risco de ocorrer distorção é alto.

Por favor consulte a seção 'Audio Monitor Setup' para informações sobre a instalação do Blackmagic Audio Monitor Setup e configuração dos tipos de medidores de nível.

Botões Solo Left e Solo Right

Estes botões permitem isolar o canal de áudio esquerdo e direito para que você possa identificar eventuais problemas no áudio de cada canal independentemente.

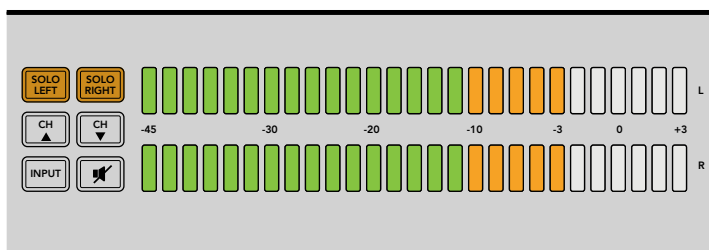

Selecionar Solo Left desativa o canal de áudio direito. O medidor de nível de áudio continuará exibindo ambos os níveis.

Como monitorar o canal de áudio esquerdo:

- 1 Pressione o botão Solo Left. O botão acenderá em verde e o áudio será reproduzido somente através do alto-falante esquerdo.
- 2 Pressione Solo Left novamente para retornar ao monitoramento de áudio estéreo.

Como monitorar o canal de áudio direito:

- 1 Pressione o botão Solo Right. O botão acenderá em verde e o áudio será reproduzido somente através do alto-falante direito.
- 2 Pressione Solo Right novamente para retornar ao monitoramento de áudio estéreo.

Channel Up e Channel Down

Estes botões permitem navegar pelos canais de áudio embutido na sua conexão SDI. Para 3G-SDI, isto inclui até 16 canais, ou 8 pares. Pressione os botões para cima ou para baixo para navegar pelos canais SDI de áudio embutido.

O Blackmagic Audio Monitor 12G suporta 12G-SDI, que inclui até 64 canais de áudio, ou 32 pares de canais. Pressione e segure os botões de seta para cima e para baixo para navegar rapidamente pelos canais.

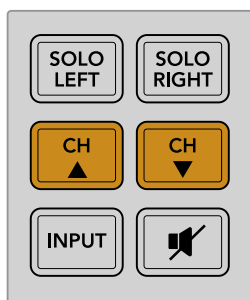

Botão Input

Ao pressionar o botão "Input" repetidamente, é possível navegar pelas entradas SDI, AES/EBU, Analógico e HiFi, assim você pode selecionar qual equipamento de vídeo e áudio deseja monitorar.

A entrada de áudio selecionada pode ser ouvida pelos alto-falantes integrados. Você também pode monitorar o áudio dos canais 1 e 2 da saída HDMI.

OBSERVAÇÃO A saída HDMI exibirá vídeo preto quando as entradas Analógica, AES/EBU ou HiFi estiverem selecionadas. A saída loop SDI sempre faz a saída dos vídeos e áudios conectados à entrada SDI.

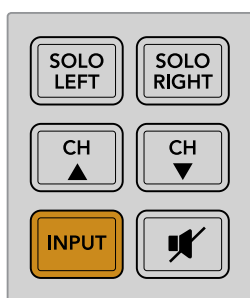

Botão Silenciar

Este botão silencia os alto-falantes e os fones de ouvido do Blackmagic Audio Monitor.

O silenciamento do áudio não afetará a entrada de áudio, somente a saída de alto-falantes e fones de ouvido. Ao pressionar o botão "Silenciar" novamente, o áudio dos alto-falantes e dos fones de ouvido será restaurado. Alternativamente, o aumento do volume também irá restaurar o áudio.

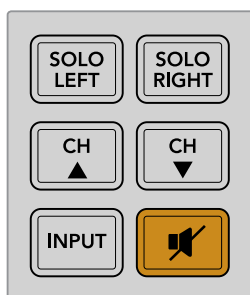

Volume

O controle giratório ajusta o volume dos alto-falantes e dos fones de ouvido independentemente.

O nível do volume é exibido no LCD integrado. Quando os fones de ouvido estão conectados, os alto-falantes do Blackmagic Audio Monitor são silenciados e o áudio é emitido pelos fones de ouvido. O volume pode ser ajustado para cima ou para baixo girando o controle no sentido horário ou no sentido anti-horário.

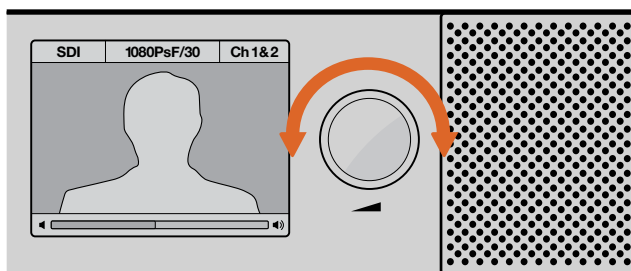

O nível do volume é exibido no painel de controle LCD.

Configurar Monitor de Áudio

Blackmagic Audio Monitor Setup

O utilitário Blackmagic Audio Monitor Setup é usado para configurar o tipo de medidor de nível de áudio desejado; e também para atualizar o software interno do seu Blackmagic Audio Monitor.

O utilitário de configuração pode ser instalado usando o cartão SD incluso, porém é recomendável baixar a versão mais recente na Central de Suporte Técnico da Blackmagic Design em www.blackmagicdesign.com/br/support.

Quando o Blackmagic Audio Monitor original é conectado a um computador via USB, você pode alterar as configurações e atualizar o software interno utilizando o utilitário de configuração. No Blackmagic Audio Monitor 12G, você também pode atualizar o dispositivo e ajustar configurações via ethernet. No entanto, para alterar as configurações de rede, será necessário conectar via USB.

O Blackmagic Audio Monitor Setup é compatível com macOS Mojave 10.14 e Windows 10 ou versões mais recentes.

Instalar no macOS

- 1 Dê um clique duplo no arquivo instalador localizado na mídia fornecida ou na pasta de downloads, caso tenha baixado o software no site da Blackmagic Design.
- 2 Siga as instruções de instalação e o macOS instalará o programa automaticamente.

Instalar no Windows

- 1 Dê um clique duplo no arquivo instalador localizado na mídia fornecida, ou na pasta de downloads, caso tenha baixado o software no site da Blackmagic Design.
- 2 Siga as instruções de instalação e aceite os termos do Acordo de Licença e o Windows instalará o software automaticamente.

Atualizar Software Interno

- 1 Conecte o Blackmagic Audio Monitor ao seu computador via USB ou Ethernet.
- 2 Abra o Blackmagic Audio Monitor Setup.
- 3 Clique no ícone de configuração e o utilitário informará caso uma atualização seja necessária.
- 4 Caso exista uma atualização disponível, clique no botão “Update” e permita que a instalação do software seja concluída.



Clique no botão “Update” para aplicar a atualização do software interno.



Uma barra de progresso indicará o status da atualização.

- 5 Clique no botão “Close” quando a atualização estiver concluída.



Atualize o software interno do seu Blackmagic Audio Monitor e ajuste as configurações usando o utilitário Blackmagic Audio Monitor Setup.

Aba Meter

Abra o utilitário de configuração e clique no ícone de configuração para revelar os parâmetros dos medidores de nível de áudio. Você pode selecionar entre os tipos de medidores VU, PPM ou Loudness com escalas de medição EBU e BBC. Embora o medidor VU tenha se tornado o padrão, os medidores PPM e Loudness fornecem sistemas de escala e métricas para a percepção da sonoridade. A tabela abaixo mostra as combinações compatíveis de medidores dos níveis de áudio e escalas de medição.

Tipo de Medidor	Tipo de Escala	Escala de Medida	Como Usar
VU	–	-45 a +3	Impresso no dispositivo
PPM	EBU	-12 a +12	Adesivo
PPM	BBC	1 a 7	Adesivo
Loudness	EBU +9	-18 a +9	Adesivo
Loudness	EBU +18	-36 a +18	Adesivo
Loudness	Full Scale +9	-41 a -14	Adesivo
Loudness	Full Scale +18	-59 a -5	Adesivo

VU

Este medidor indica a média de altos e baixos no seu sinal de áudio. Geralmente, é utilizado para monitorar os picos, no entanto, devido a sua capacidade de determinar os valores médios, também pode ser utilizado para monitorar a percepção da sonoridade.

PPM

Este medidor com o recurso “retenção de pico” exibe e preserva os picos do sinal temporariamente, com uma queda lenta para que você possa identificar onde seu áudio está atingindo o nível máximo com facilidade.

Loudness

Este medidor exibe a qualidade subjetiva da sonoridade do seu sinal de áudio. Os padrões broadcast atuais incluem medição de loudness a fim de obter níveis consistentes.

Os medidores VU e PPM incluem um nível de referência selecionável de -18 dB ou -20 dB, para que você possa monitorar o áudio de acordo com diferentes padrões de transmissão internacionais.

Os LEDs do Blackmagic Audio Monitor se iluminam de maneira diferente dependendo do tipo de medidor selecionado. Rótulos adesivos com escalas de referência precisas em dB são fornecidas com seu Blackmagic Audio Monitor para ajudar a identificar onde o seu áudio está atingindo níveis máximos com facilidade. Para aplicar os rótulos, coloque o adesivo desejado entre os medidores coloridos, cobrindo as marcações da escala VU presentes.

Para cada tipo de medidor de nível de áudio e escala de medição são fornecidos dois adesivos. Os adesivos também estão disponíveis através da assistência técnica Blackmagic Design mais próxima. Visite a Central de Suporte Técnico da Blackmagic Design em www.blackmagicdesign.com/br/support para encontrar sua equipe de apoio local.



Selecione o tipo de indicador desejado e, em seguida, clique no botão "Save".

EBU PPM									
-12	-8	-4	0	+4	+8	+12			
-12	-8	-4	0	+4	+8	+12			
BBC PPM									
1	2	3	4	5	6	7			
1	2	3	4	5	6	7			
Loudness Units EBU +9dB									
-18	-15	-12	-9	-6	-3	0	+3	+6	+9
-18	-15	-12	-9	-6	-3	0	+3	+6	+9
Loudness Units Fullscale +9dB									
-41	-38	-35	-32	-29	-26	-23	-20	-17	-14
-41	-38	-35	-32	-29	-26	-23	-20	-17	-14
Loudness Units EBU +18dB									
-36	-30	-24	-18	-12	-6	0	+6	+12	+18
-36	-30	-24	-18	-12	-6	0	+6	+12	+18
Loudness Units Fullscale +18dB									
-59	-53	-47	-41	-35	-29	-23	-17	-11	-5
-59	-53	-47	-41	-35	-29	-23	-17	-11	-5

Os adesivos permitem identificar exatamente o ponto em que o áudio está atingindo o pico nos diferentes medidores.

Aba Configure

O Blackmagic Audio Monitor 12G possui uma aba de configurações adicional que exibe o número da versão do software e contém as configurações de rede do seu Blackmagic Audio Monitor. Você também pode rotular a sua unidade com um nome personalizado. Isto ajuda a localizar o dispositivo quando conectado remotamente.

Denominar seu Blackmagic Audio Monitor 12G

Como denominar seu Blackmagic Audio Monitor 12G:

- 1 Click na aba “Configure”.
- 2 Na configuração “Details”, clique na caixa de texto “Name” e insira um novo rótulo.
- 3 Clique em “Save”.



Alterar Configurações de Rede

Acessar o seu Blackmagic Audio Monitor 12G através de uma rede é a maneira mais fácil de gerenciar múltiplas unidades. Você pode fazer isto através do Blackmagic Audio Monitor Setup. Por padrão, o seu Blackmagic Audio Monitor 12G é configurado para obter um endereço de rede automaticamente, facilitando a seleção de um endereço na tela principal do utilitário de configuração.

Caso esteja com dificuldade de encontrar um Blackmagic Audio Monitor 12G na sua rede - ou o tenha configurado anteriormente para usar um endereço estático incompatível com a sua rede atual - talvez seja necessário alterar as configurações de rede a nível local. Isso pode ser feito via USB.

Alterar Configurações de Rede via USB

Para alterar as configurações de rede via USB, conecte o seu Blackmagic Audio Monitor 12G a um computador que esteja operando o utilitário Blackmagic Audio Monitor Setup com um cabo USB. O conector USB encontra-se no painel traseiro do Blackmagic Audio Monitor 12G. Uma vez conectado, selecione o seu Audio Monitor 12G na tela principal do utilitário Blackmagic Audio Monitor Setup e navegue até a aba “Configure”. Aqui você pode alternar entre endereços de rede dinâmicos ou estáticos. Caso selecione um IP estático, é possível configurar endereço, máscara de sub-rede e gateway manualmente.

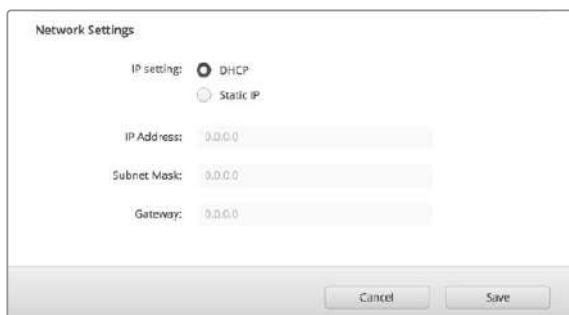

Instalar Módulo Decodificador Blackmagic Dolby® Opcional

O módulo decodificador Dolby saiu de linha. No entanto, caso você possua o módulo para o Blackmagic Audio Monitor original e deseje instalá-lo, por favor siga as instruções nesta página.

OBSERVAÇÃO O Blackmagic Audio Monitor 12G não é compatível com o módulo decodificador Dolby opcional.

ADVERTÊNCIA

Assegure-se de que a alimentação do seu Blackmagic Audio Monitor esteja desconectada antes de instalar o módulo decodificador Dolby, pois a instalação requer a retirada da tampa do chassi para acessar a placa-mãe. Este procedimento deve ser realizado somente por indivíduos qualificados. Durante a instalação do módulo, também é necessário se precaver para reduzir o risco de descarga eletroestática.

Instalar Módulo

Com um módulo decodificador Blackmagic Dolby, você pode monitorar o áudio Dolby Digital ou Dolby E utilizado nas produções cinematográficas e televisivas modernas. O som surround Dolby 5.1 é codificado com canais frontais esquerdo e direito, canais surround traseiros esquerdo e direito, um canal central, além de um canal para frequências graves de baixa frequência.

O decodificador Dolby é um módulo SIMM de 72 pinos que pode ser instalado facilmente no slot SIMM vazio da placa-mãe do Blackmagic Audio Monitor.

Como instalar o módulo decodificador Blackmagic Dolby:

- 1 Certifique-se de que a alimentação do Blackmagic Audio Monitor esteja desconectada.
- 2 Desparafuse os 21 parafusos da tampa do Blackmagic Audio Monitor utilizando uma chave Phillips. Retire a tampa.
- 3 Segure o módulo decodificador Blackmagic Dolby com os contatos voltados para o compartimento SIMM vazio. A abertura do SIMM precisa estar alinhada com a ranhura, caso contrário o SIMM não se encaixará corretamente.
- 4 Insira o módulo no compartimento SIMM com cuidado até que os contatos estejam encaixados firmemente.
- 5 Incline o módulo em direção à parte traseira do Blackmagic Audio Monitor até que as travas metálicas se prendam nos dois lados do módulo.
- 6 Coloque a tampa e os 21 parafusos novamente.

Após instalar o módulo decodificador Blackmagic Dolby, coloque o adesivo Dolby fornecido no painel traseiro do Blackmagic Audio Monitor, próximo ao adesivo de advertência, para indicar que o módulo Dolby foi instalado.

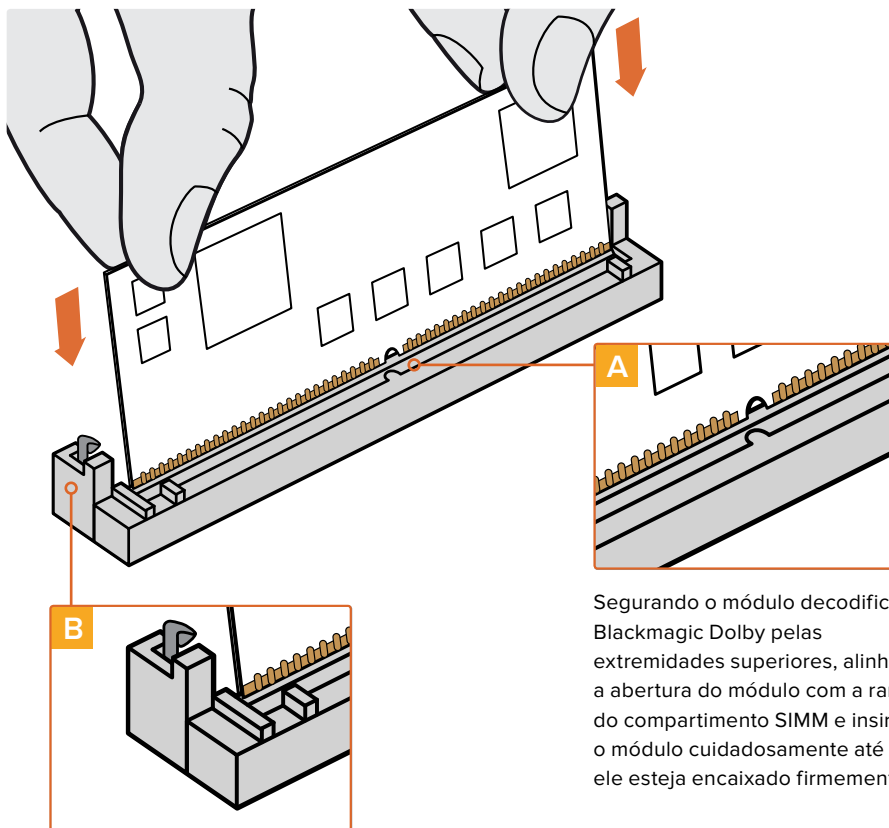

Apoie o módulo decodificador Blackmagic Dolby em direção à parte traseira do chassi até que os cliques de metal se ajustem em ambas as laterais.

Segurando o módulo decodificador Blackmagic Dolby pelas extremidades superiores, alinhe a abertura do módulo com a ranhura do compartimento SIMM e insira o módulo cuidadosamente até que ele esteja encaixado firmemente.

Confirmar Dolby Audio

Quando o áudio Dolby codificado é detectado pelo Blackmagic Audio Monitor, o logotipo Dolby é exibido no canto superior direito do painel de controle LCD. Você pode monitorar quatro pares de canais Dolby surround ao pressionar os botões de canal para baixo e para cima no painel de controle.

Informações para Desenvolvedores

Controlar Blackmagic Audio Monitor 12G usando Telnet

Com o protocolo de Ethernet Blackmagic Audio Monitor 12G, você tem a liberdade de criar suas próprias soluções de controle personalizadas para o seu Blackmagic Audio Monitor 12G. Por exemplo, é possível criar o seu próprio aplicativo de software ou interface online para controlar seu Audio Monitor 12G via Ethernet através do seu computador.

O primeiro passo é conectar o seu Blackmagic Audio Monitor 12G ao seu computador através da Ethernet. Você pode fazer isto se conectando à mesma rede que o seu computador ou conectando o Blackmagic Audio Monitor 12G diretamente ao seu computador.

OBSERVAÇÃO Se o Blackmagic Audio Monitor 12G estiver conectado ao seu computador, configure o computador com um endereço IP estático manual. Defina os três primeiros blocos de números no endereço IP para corresponder ao seu Blackmagic Audio Monitor 12G e defina a máscara de sub-rede como 255.255.255.0. Você pode deixar o gateway ou a configuração do roteador em branco, já que não serão usados em uma conexão direta entre o seu computador e o Blackmagic Audio Monitor 12G.

Se as suas configurações de rede estiverem definidas corretamente, agora você pode abrir o aplicativo Terminal no MacOS ou habilitar os utilitários da linha de comando Telnet no Windows e inserir os comandos do protocolo de controle do Blackmagic Audio Monitor 12G. Esses comandos podem ser programados no seu aplicativo e disparados pelos itens relacionados em uma interface do usuário personalizada com o seu próprio design.

Usar Telnet no MacOs e Windows

- 1 No MacOS, abra o aplicativo Terminal, localizado em Aplicativos > pasta Utilitários.
Para abrir o prompt de comando no Windows, clique no menu “Iniciar” e digite “cmd” na barra de pesquisa. Pressione “Enter”.
- 2 Digite “telnet” com um espaço seguido do endereço IP do seu computador, com outro espaço e “9996”, que é o número de porta padrão para o Blackmagic Audio Monitor 12G.
Por exemplo:

```
telnet 192.168.25.253 9996
```

Pressione “Enter”. A tela de preâmbulo do protocolo aparecerá.

Blackmagic Audio Monitor 12G Ethernet Protocol V1.0

Resumo

O protocolo de ethernet Blackmagic Audio Monitor 12G é um protocolo baseado em texto que pode ser acessado com a conexão à porta TCP 9996 de um Blackmagic Audio Monitor 12G.

O Blackmagic Audio Monitor envia informações em blocos, os quais possuem um cabeçalho de identificação em letras maiúsculas, seguidas de dois pontos. Um bloco abrange múltiplas linhas e é encerrado por uma linha em branco.

Cada linha no protocolo é encerrada por um caractere “newline”.

Após ser conectado, o Blackmagic Audio Monitor 12G envia um despejo completo do estado do dispositivo. Depois do despejo de status inicial, as atualizações de status são enviadas todas as vezes que o status do Blackmagic Audio Monitor 12G é alterado.

Para ser flexível em relação às alterações futuras do protocolo, os clientes devem ignorar os blocos que não reconhecem, até a linha em branco à direita. Nos blocos existentes, os clientes devem ignorar as linhas que não reconhecem.

Legenda

↵ alimentação de linha ou retorno de carro
... sucessivamente

A versão 1.0 do Blackmagic Audio Monitor 12G Ethernet Protocolo foi lançada com o software Blackmagic Monitor 12G 3.0.

Preâmbulo do Protocolo

O primeiro bloco enviado pelo Blackmagic Audio Monitor 12G é sempre o preâmbulo do protocolo.

```
PROTOCOL PREAMBLE:  
Version: 1.0
```

O campo da versão indica a versão do protocolo. Quando o protocolo é alterado de maneira compatível, o número da versão de manutenção é atualizado. Se alterações incompatíveis são feitas, o número da versão principal é atualizado.

Informações do Dispositivo

O bloco a seguir contém informações gerais sobre o dispositivo Blackmagic Audio Monitor 12G conectado. Se um dispositivo estiver conectado, o Blackmagic Audio Monitor 12G relatará os atributos do Blackmagic Audio Monitor 12G.

```
AUDIOMONITOR DEVICE:↵  
Model: Blackmagic Audio Monitor 12G  
Label: Blackmagic Audio Monitor 12G
```

Somente o rótulo pode ser alterado.

```
AUDIOMONITOR DEVICE:↵  
Label: My new name↵  
↵
```

A resposta será:

```
ACK:  
AUDIOMONITOR DEVICE:  
Label: My new name
```

O bloco seguinte exibirá as informações de rede, que podem ser alteradas apenas via o utilitário Blackmagic Audio Monitor Setup, quando conectado por USB. Isto é meramente informativo.

```
NETWORK:  
Dynamic IP: 1  
Current address: 0.0.0.0  
Current subnet: 0.0.0.0  
Current gateway: 0.0.0.0
```

O bloco seguinte é o tipo de medição.

```
AUDIO METER:  
Meter Mode: VU (-20dBFS Ref)
```

Isto pode ser alterado para VU (-20dBFS Ref), VU (-18dBFS Ref), PPM EBU (-20dBFS Ref), PPM EBU (-18dBFS Ref), PPM BBC (-20dBFS Ref), PPM BBC (-18dBFS Ref), Loudness (EBU +9 scale) ou Loudness (EBU +18 scale)

```
AUDIO METER:↵  
Meter Mode: Loudness (EBU +18 scale)↵  
↵
```

A resposta será:

```
ACK:  
AUDIO METER:  
Meter Mode: Loudness (EBU +18 scale)
```

O bloco seguinte é o tipo de entrada.

```
AUDIO INPUT:  
Routing: Speaker Stereo SDI Stereo 1-2
```

Isto pode ser alterado para SDI Stereo 3-4, SDI Stereo 5-6, SDI Stereo 7-8, SDI Stereo 9-10, SDI Stereo 11-12, SDI Stereo 13-14, SDI Stereo 15-16, XLR AES/EBU Stereo 1-2, XLR Analog Stereo ou RCA Stereo

```
AUDIO INPUT:↵  
Routing: Speaker Stereo XLR AES/EBU Stereo 1-2↵  
↵
```

A resposta será:

```
ACK:  
AUDIO INPUT:  
Routing: Speaker Stereo XLR AES/EBU Stereo 1-2
```

O bloco seguinte é o estado de saída de áudio. Isto indica as configurações de volume atuais para o fone de ouvido e alto-falante, além do estado dos botões silenciar e solo.

```
AUDIO OUTPUT:  
Gain: Speaker Stereo 0  
Gain: Headphone Stereo 0  
Mute: false  
Solo: Off
```

As configurações de ganho do volume podem ser definidas entre 0 e 255. Silenciar pode ser verdadeiro ou falso e Solo pode ser “Off” (desativado), “Left” (esquerda) ou “Right” (direita).

```
AUDIO OUTPUT:↵  
Gain: Speaker Stereo 125↵  
Solo: Right↵  
↵
```

A resposta será:

```
ACK:  
AUDIO OUTPUT:  
Gain: Speaker Stereo 125  
Solo: Right
```

Verificar Conexão

Enquanto a conexão com o Blackmagic Audio Monitor 12G estiver estabelecida, o cliente pode enviar um comando especial “no-operation” para verificar se o Blackmagic Audio Monitor 12G ainda está respondendo:

```
PING:↵  
↵
```

Se o Blackmagic Audio Monitor 12G estiver respondendo, ele enviará uma mensagem ACK, como para qualquer outro comando reconhecido.

Verificar Comandos de Protocolo Válidos

Enquanto a conexão ao Blackmagic Audio Monitor 12G estiver estabelecida, um cliente pode enviar um comando “HELP” especial para obter a lista de comandos compatíveis com Telnet:

```
HELP:↵  
↵  
AUDIOMONITOR DEVICE:  
Model: <label> [read only]  
Label: <label>  
Unique ID: <label> [read only]  
  
NETWORK:  
Dynamic IP: <boolean> [read only]  
Current address: <IP_address> [read only]  
Current subnet: <IP_address> [read only]  
Current gateway: <IP_address> [read only]  
  
AUDIO METER:  
Meter Mode: <enum> -> <enum> = <"VU (-20dBFS Ref)" | "VU (-18dBFS Ref)" |  
"PPM EBU (-20dBFS Ref)" | "PPM EBU (-18dBFS Ref)" | "PPM BBC (-20dBFS Ref)"  
| "PPM BBC (-18dBFS Ref)" | "Loudness (EBU +9 scale)" | "Loudness (EBU  
+18 scale)">;  
  
AUDIO INPUT:  
Routing: <enum1> <enum2> -> <enum1> = <"Speaker Stereo">; <enum2> = <"SDI  
Stereo 1-2" | "SDI Stereo 3-4" | "SDI Stereo 5-6" | "SDI Stereo 7-8" | "SDI  
Stereo 9-10" | "SDI Stereo 11-12" | "SDI Stereo 13-14" | "SDI Stereo 15-16" |  
"XLR AES/EBU Stereo 1-2" | "XLR Analog Stereo" | "RCA Stereo">;  
  
AUDIO OUTPUT:  
Gain: <enum> <integer> -> <enum> = <"Speaker Stereo" | "Headphone Stereo">;  
<integer> = <0..255>;  
  
Mute: <boolean> -> <boolean> = <true | false>;  
  
Solo: <enum> -> <enum> = <"Off" | "Left" | "Right">;
```

Ajuda

Obter Ajuda

A maneira mais rápida de obter ajuda é visitando as páginas de suporte online da Blackmagic Design e consultando os materiais de suporte mais recentes disponíveis para o seu Blackmagic Audio Monitor.

Páginas de Suporte Online da Blackmagic Design

O manual, o software e as notas de suporte mais recentes podem ser encontrados na Central de Suporte Técnico da Blackmagic Design www.blackmagicdesign.com/br/support.

Fórum Blackmagic Design

O fórum da Blackmagic Design no nosso site é um recurso útil que você pode acessar para mais informações e ideias criativas. Também pode ser uma maneira mais rápida de obter ajuda, pois já podem existir respostas de outros usuários experientes e da equipe da Blackmagic Design, o que o ajudará a seguir em frente. Você pode visitar o fórum em <https://forum.blackmagicdesign.com>

Contatar o Suporte Blackmagic Design

Caso não encontre a ajuda que precisa no nosso material de suporte ou no fórum, por favor, use o botão “Enviar email” na página de suporte para nos encaminhar uma solicitação de suporte. Ou, clique no botão “Encontre sua equipe de suporte local” na página de suporte e ligue para a assistência técnica da Blackmagic Design mais próxima.

Verificar a Versão de Software Atualmente Instalada

Para verificar a versão do software Blackmagic Audio Monitor Setup instalada no seu computador, abra a janela “About Blackmagic Audio Monitor Setup”.

- No macOS, abra o Blackmagic Audio Monitor Setup na pasta “Aplicativos”. Selecione “About Blackmagic Audio Monitor” no menu do aplicativo para revelar o número da versão.
- No Windows 10, abra o Blackmagic Audio Monitor Setup do ladrilho Blackmagic Audio Monitor Setup na sua página Iniciar. Clique no menu de ajuda e selecione “Sobre Blackmagic Audio Monitor Setup” para revelar o número da versão.

Como Obter as Atualizações de Software Mais Recentes

Depois que verificar a versão do software Blackmagic Audio Monitor Setup instalada no seu computador, por favor, visite a Central de Suporte Técnico da Blackmagic Design em www.blackmagicdesign.com/br/support para conferir as últimas atualizações. Embora seja uma boa ideia instalar as últimas atualizações, é recomendável evitar atualizar qualquer software caso esteja no meio de um projeto importante.

Informações Regulatórias

Descarte de Resíduos de Equipamentos Elétricos e Eletrônicos na União Europeia



O símbolo no produto indica que este equipamento não pode ser eliminado com outros materiais residuais. Para eliminar seus resíduos de equipamento, eles devem ser entregues a um ponto de coleta designado para reciclagem. A coleta separada e a reciclagem dos seus resíduos de equipamento no momento da eliminação ajudarão a preservar os recursos naturais e a garantir que sejam reciclados de uma maneira que proteja a saúde humana e o meio ambiente. Para mais informações sobre onde você pode entregar os resíduos do seu equipamento para reciclagem, por favor entre em contato com a agência de reciclagem local da sua cidade ou o revendedor do produto adquirido.



Este equipamento foi testado e respeita os limites para um dispositivo digital Classe A, conforme a Parte 15 das normas da FCC. Esses limites foram criados para fornecer proteção razoável contra interferências nocivas quando o equipamento é operado em um ambiente comercial. Este equipamento gera, usa e pode irradiar energia de radiofrequência e, se não for instalado ou usado de acordo com as instruções, poderá causar interferências nocivas nas comunicações via rádio. A operação deste produto em uma área residencial pode causar interferência nociva, nesse caso o usuário será solicitado a corrigir a interferência às suas próprias custas.

A operação está sujeita às duas condições a seguir:

- 1 Este dispositivo não poderá causar interferência nociva.
- 2 Este dispositivo deve aceitar qualquer interferência recebida, incluindo interferência que possa causar uma operação indesejada.

Norma Canadense ISED

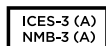

Este dispositivo cumpre com as exigências canadenses para aparelhos digitais de classe A.

Quaisquer modificações ou utilização deste produto fora dos limites previstos poderão anular a conformidade com estas normas.

A conexão com interfaces HDMI deve ser feita com cabos HDMI protegidos.

Este equipamento foi testado para fins de cumprimento com a sua utilização pretendida em um ambiente comercial. Se o equipamento for usado em um ambiente doméstico, poderá causar interferência radioelétrica.

Informações de Segurança

Para proteção contra choque elétrico, o equipamento deve estar conectado à uma tomada com conexão de aterramento de proteção. Em caso de dúvida, consulte um eletricista qualificado.

Para reduzir o risco de choque elétrico, não exponha este equipamento a pingos ou respingos.

O produto é adequado para uso em locais tropicais com temperatura ambiente de até 40°C.

Certifique-se de que ventilação adequada seja fornecida ao redor do produto e não esteja restringida.

Ao montar o produto em rack, certifique-se de que a ventilação não esteja restringida por equipamentos adjacentes.

Não há componentes internos reparáveis pelo operador. Solicite o serviço de manutenção à assistência técnica local da Blackmagic Design.



Utilize apenas em altitudes inferiores a 2000 m acima do nível do mar.

Declaração do Estado da Califórnia

Este produto pode expô-lo a produtos químicos, tais como vestígios de bifenilos polibromados dentro de peças de plástico, considerados pelo estado da Califórnia como causadores de câncer e defeitos congênitos ou outros danos reprodutivos.

Para mais informações, visite www.P65Warnings.ca.gov.

Garantia

12 Meses de Garantia Limitada

A Blackmagic Design garante que este produto estará isento de quaisquer defeitos de materiais e fabricação por um período de 12 meses a partir da data de compra. Se o produto se revelar defeituoso durante este período de garantia, a Blackmagic Design, a seu critério, consertará o produto defeituoso sem cobrança pelos componentes e mão-de-obra, ou fornecerá a substituição em troca pelo produto defeituoso.

Para obter o serviço sob esta garantia você, o Consumidor, deve notificar a Blackmagic Design do defeito antes da expiração do período de garantia e tomar as providências necessárias para o desempenho do serviço. O Consumidor é responsável pelo empacotamento e envio do produto defeituoso para um centro de assistência designado pela Blackmagic Design com os custos de envio pré-pagos. O Consumidor é responsável pelo pagamento de todos os custos de envio, seguro, taxas, impostos e quaisquer outros custos para os produtos retornados para nós por qualquer razão.

Esta garantia não se aplica a defeitos, falhas ou danos causados por uso inadequado ou manutenção e cuidado inadequado ou impróprio. A Blackmagic Design não é obrigada a fornecer serviços sob esta garantia: a) para consertar danos causados por tentativas de instalar, consertar ou fornecer assistência técnica ao produto por pessoas que não sejam representantes da Blackmagic Design, b) para consertar danos causados por uso ou conexão imprópria a equipamentos não compatíveis, c) para consertar danos ou falhas causadas pelo uso de componentes ou materiais que não são da Blackmagic Design, d) para fornecer assistência técnica de um produto que foi modificado ou integrado a outros produtos quando o efeito de tal modificação ou integração aumenta o tempo ou a dificuldade da assistência técnica do serviço. ESTA GARANTIA É FORNECIDA PELA BLACKMAGIC DESIGN NO LUGAR DE QUAISQUER OUTRAS GARANTIAS, EXPLÍCITAS OU IMPLÍCITAS. A BLACKMAGIC DESIGN E SEUS FORNECEDORES NEGAM QUAISQUER GARANTIAS IMPLÍCITAS DE COMERCIALIZAÇÃO OU ADEQUAÇÃO A UMA FINALIDADE ESPECÍFICA. A RESPONSABILIDADE DA BLACKMAGIC DESIGN DE CONSERTAR OU SUBSTITUIR PRODUTOS DEFEITUOSOS É A ÚNICA E EXCLUSIVA MEDIDA FORNECIDA AO CONSUMIDOR PARA QUAISQUER DANOS INDIRETOS, ESPECIAIS OU ACIDENTAIS INDEPENDENTEMENTE DA BLACKMAGIC DESIGN OU DO FORNECEDOR TIVER INFORMAÇÃO PRÉVIA SOBRE A POSSIBILIDADE DE TAIS DANOS. A BLACKMAGIC DESIGN NÃO É RESPONSÁVEL POR QUAISQUER USOS ILEGAIS DO EQUIPAMENTO PELO CONSUMIDOR. A BLACKMAGIC NÃO É RESPONSÁVEL POR QUAISQUER DANOS CAUSADOS PELO USO DESTE PRODUTO. O USUÁRIO DEVE OPERAR ESTE PRODUTO POR CONTA E RISCO PRÓPRIOS

© Direitos autorais 2020 Blackmagic Design. Todos os direitos reservados. 'Blackmagic Design', 'DeckLink', 'HDLINK', 'Workgroup Videohub', 'Multibrigde Pro', 'Multibrigde Extreme', 'Intensity' e 'Leading the creative video revolution' são marcas comerciais registradas nos Estados Unidos e em outros países. Todos os outros nomes de empresas e produtos podem ser marcas comerciais de suas respectivas empresas com as quais elas são associadas.



Kurulum ve Kullanım Kılavuzu

Blackmagic Audio Monitor 12G

Ocak 2020

Türkçe



Hoş Geldiniz

Blackmagic Audio Monitor'u satın aldığınız için teşekkür ederiz.

Herkesin en yüksek kalitedeki video ekipmanına erişim sağlamasını mümkün kılarak, televizyon endüstrisinin tam anlamıyla yaratıcı bir endüstri olmasına ilişkin hayalimizi paylaştığınızı umuyoruz.

İster yayıncılık, post prodüksiyon ya da canlı yapımlar olsun, ses denetleme her türlü video yapımında önemli bir yer teşkil eder. Blackmagic Audio Monitor profesyonel ses ekranlarının tüm özelliklerini size bir kompakt rack montajlı tasarımda sunuyor. Yüksek kalitede denetleme için hemen hemen her türlü ses ekipmanını bağlayabilirsiniz. Orijinal Blackmagic Audio Monitor, saniyede 30 kareye kadar Ultra HD videonun bağlanması için 6G-SDI'yi destekler. Blackmagic Audio Monitor 12G, saniyede 60 kareye kadar Ultra HD videonun bağlanması için 12G-SDI'yi ve level A ve B 3G-SDI video sinyal girişlerini destekler.

Bu kurulum ve kullanım kılavuzu Blackmagic Audio Monitor'u kullanmaya başlamanız için ihtiyacınız olan tüm bilgileri içerir.

Lütfen internet sitemizdeki destek bilgilerini içeren sayfamıza www.blackmagicdesign.com/tr adresinden girerek, bu kullanım kılavuzunun en güncel versiyonuna ve Blackmagic Audio Monitor'un dahili yazılımı için güncellemelere erişim sağlayın. Dahili yazılımınızı güncel tutarak en son özelliklerden yararlandığınızdan emin olabilirsiniz. Yeni yazılımlar piyasaya sürüldüğünde size duyurabilmemiz için, bilgisayarınıza yazılım indirirken bilgilerinizi sitemize kaydetmenizi rica ediyoruz. Sürekli yeni özellikler ve geliştirmeler için çaba içinde olduğumuzdan, yorumlarınızı almaktan mutluluk duyarız.

Grant Petty

CEO Blackmagic Design

İçindekiler

Blackmagic Audio Monitor 12G

Başlarken	225
Blackmagic Audio Monitor ile tanışın	225
Ses Kaynaklarının Bağlanması	225
Ses Kaynağının Seçilmesi	226
Video Çıkışlarının Bağlanması	226
Blackmagic Audio Monitor'un Kullanılması	227
Kontrol Panelinin Kullanılması	227
LCD	227
Ses Düzeyi Göstergeleri	227
Solo Sol (Left) ve Solo Sağ (Right) Düğmeleri	228
Üstteki Kanal (Channel Up) ve Alttaki Kanal (Channel Down)	228
Giriş	229
MUTE (Ses Kapatma)	229
Ses Seviyesi	229
Audio Monitor Kurulumu	230
Blackmagic Audio Monitor Kurulumu	230
macOS Kurulumu	230
Windows Kurulumu	230
Dahili Yazılımın Güncellenmesi	230
Göstergeler Sekmesi	231
Configure (Yapılandırma) Sekmesi	233
Ağ Ayarlarının Değiştirilmesi	233
Opsiyonel Blackmagic Dolby® Kod Çözücü Modülünün Takılması	234
Modülün Takılması	234
Dolby Sesin Teyit Edilmesi	235
Yazılım Geliştirici Bilgileri	236
Controlling Blackmagic Audio Monitor 12G using Telnet	236
Blackmagic Audio Monitor 12G Ethernet Protocol V1.0	236
Yardım	240
Mevzuata İlişkin Bildirimler	241
Güvenlik Bilgileri	242
GARANTİ	243

Başlarken

Blackmagic Audio Monitor ile tanışın

Blackmagic Audio Monitor ve Blackmagic Audio Monitor 12G canlı, post prodüksiyon ve yayın ortamlarında, çeşitli video ve ses kaynaklarıyla kullanılabilen bir rack boyutunda gerçek zamanlı ses denetleme çözümleridir.

Blackmagic Audio Monitor, çıkışlarda doğru ses seviyelerinin sağlanması için, SD/HD/3G/6G-SDI, dijital AES/EBU ve analog ses ekipmanlarına bağlanır. 12G modeli 12G-SDI'yi desteklediğinden, saniyede 60 kareye kadar olan Ultra HD video kaynaklarına bağlayabilirsiniz. Sol ve sağ kanal LED seviye göstergeleri, sesin nerede pik yaptığını gösterir ve dahili LCD ekran da SDI video girişinizi göstermekle birlikte; giriş bağlantı türü, video formatı, kare hızı, ses kanalları ve ses seviyesi gibi önemli bilgileri gösterir.

16 adede kadar gömülü SDI ses içeren kanalı denetleyebilir ya da dengeli analog ve AES/EBU dijital ses için XLR konektörlerini kullanabilirsiniz. Ayrıca, HiFi sistemleri veya iPod gibi tüketici ekipmanlarını takabilmeniz için, RCA konektörleri de mevcuttur.

Blackmagic Audio Monitor'unuz, iki adet dahili, yüksek kaliteli geniş frekans aralıklı hoparlör ve oldukça net ve derin ses üretimi için, geniş çeşitte frekans aralıkları sunan iki subwoofer içerir. Gürültülü ortamlarda ideal olan, güvenli ses denetleme için bir kulaklık da takabilirsiniz.



Blackmagic Audio Monitor 12G'nin ön paneli



Blackmagic Audio Monitor 12G'nin arka paneli

Ses Kaynaklarının Bağlanması

Blackmagic Audio Monitor neredeyse her türlü ses donanımını destekler. SDI sinyallerini; SD, HD, 2K ve hatta Ultra HD olarak bağlamak istiyorsanız, standart bir BNC konektör kullanarak SDI girişi ile takabilirsiniz. 12G modeli level A ve B 3G-SDI video sinyal girişlerini destekler.

Disk kaydediciler ve dijital ses konsolları da dahil olmak üzere, dijital AES/EBU ses ekipmanlarından veya ses mikserleri ya da Betacam SP deck'leri gibi analog ekipmanlardan, dijital sesi denetlemek istediğinizde XLR konektörlerini kullanabilirsiniz. VCR ve DVD oynatıcıları gibi tüketici ekipmanlarından gelen analog ses kaynakları, standart RCA konektörler ile bağlanabilirler. Aynı zamanda, başkalarını rahatsız etmeden ses kaynağınızı dinleyebilmeniz için kulaklıklarınızı 1/4" TRS kulaklık jak aracılığıyla bağlayabilirsiniz.

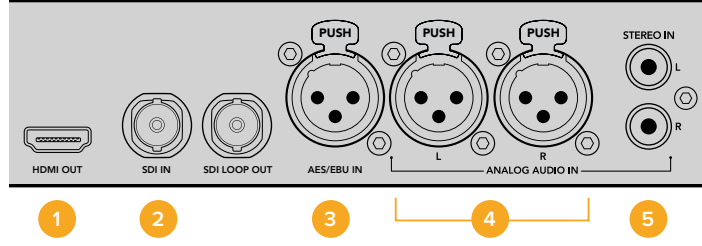

1. HDMI 2. SDI gömülü ses 3. AES/EBU için XLR
4. Analog ses için XLR 5. Tüketici ses bağlantıları için RCA

Ses Kaynağının Seçilmesi

Ses ekipmanınızı Blackmagic Audio Monitor'a taktıktan sonra yapmanız gereken tek şey, kontrol panelindeki INPUT (GİRİŞ) düğmesine basarak bağlantıyı seçmek olacaktır. Giriş seçildiğinde ve ses mevcut olduğunda, ses seviye göstergesi LED'lerinin yandığını göreceksiniz. Ses seviye göstergesi 2 sıra halinde renkli LED'lerden oluşmaktadır ve ses girişinizin çalışıp çalışmadığını kolayca anlayabilmeniz için parlak bir şekilde aydınlatılmıştır.

INPUT düğmesi, ses bağlantılarınız arasında gezinmenize imkan verir ve bunları renkli LCD üzerinde; giriş türü, ses kanalları ve ses seviyesi gibi bilgilerle birlikte görebilirsiniz. Sesi, Blackmagic Audio Monitor ile denetlemek için yapmanız gerekenler bu kadar.

Video Çıktılarının Bağlanması

Ses denetlemenin yanı sıra videonun da denetlenmesine ihtiyacınız olduğunda, Blackmagic Audio Monitor'un video çıktıları, video ile sesin bir büyük ekranda denetlenmesine veya daha çok sayıda video ekipmanın bağlanmasına imkan verir.

HDMI çıkışı ile SDI loop çıkışı, videonun ve gömülü sesin denetlenmesi için kullanılabilir. SD, HD ve 2K'ya bağlanabilir ve hatta DeckLink 4K Extreme gibi Ultra HD görüntü yakalama kartlarına tek bir SDI kablo ile bağlanabilirsiniz. Gömülü ses içeren video kaynaklarını, SD/HD-SDI üzerinden HyperDeck Studio gibi kaydedici deck'lere ya da HDMI aracılığıyla en son Ultra HD ekranlara veya projektörlere bağlayabilirsiniz.

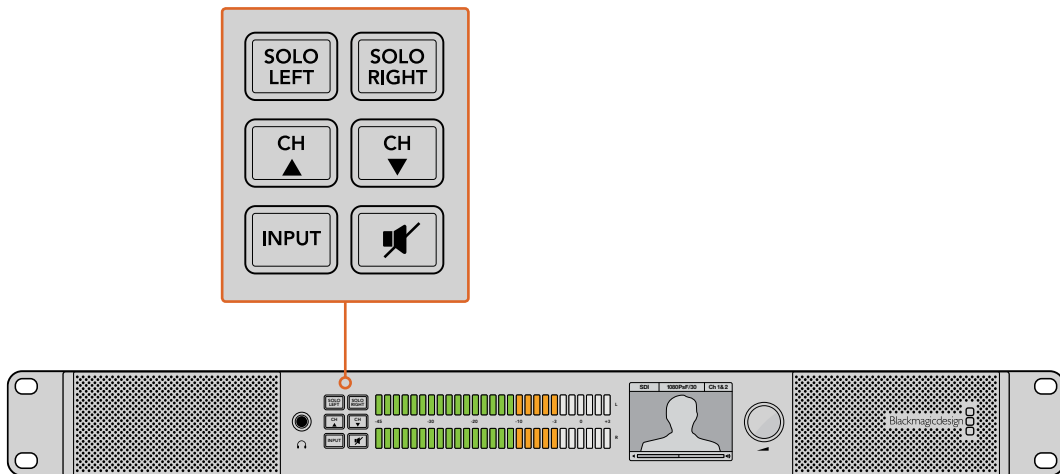

Seçenek düğmeleri, denetlemek istediğiniz girişleri seçmenize, sol ve sağ stereo kanallarını izole etmenize, mevcut ses kanalları arasında yukarı veya aşağı gezinmenize ve hoparlörler ile kulaklıkların sesini kapatmanıza imkan tanır.

Blackmagic Audio Monitor'un Kullanılması

Kontrol Panelinin Kullanılması

Blackmagic Audio Monitor'un kontrol paneli önemli işlevlere ve durum bilgilerine hızlı erişim sağlar.

LCD

Renkli, dahili LCD ekran; seçilmiş olan girişler, SDI'nın bağlı olduğu durumlarda video formatı, seçilmiş olan kanallar ve hoparlörleriniz veya kulaklıklarınız için ses seviyesi gibi önemli bilgileri görüntüleyen bir yazı katmanı içerir. LCD ekran ayrıca, gelen tüm SDI video sinyallerini de görüntüler. Bir SDI video sinyali tespit edilmediğinde, bir müzik ikonu belirecektir.

Seçilmiş olan her bir giriş için aşağıdaki bilgiler görüntülenecektir:

SDI Girişi

SDI, video formatı, seçilmiş olan ses kanalları.

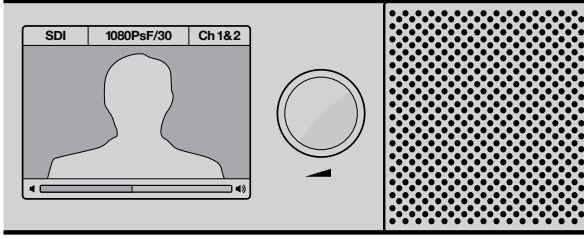

Renkli LCD ekran; bağlantı türü, video formatı, seçilmiş olan ses kanalları ve ses seviyesi gibi ses ve video ile ilgili bilgileri görüntüler.

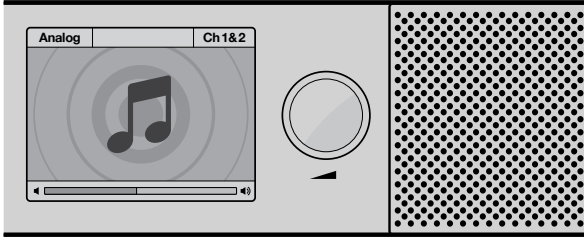

Bir SDI video sinyalinin izlendiği durumlar hariç, LCD ekranda bir müzik ikonu belirecektir.

Dengeli AES/EBU XLR girişi

AES/EBU, seçilmiş olan ses kanalları.

Dengeli XLR analog girişler

Analog, seçilmiş ses kanalları

Dengesiz RCA analog girişler

HiFi, seçilmiş ses kanalları

Ses Düzeyi Göstergeleri

Blackmagic Audio Monitor'un seviye göstergeleri, ses seviyelerinizin gücünü gösteren yeşil, turuncu ve kırmızı renklerde olan iki sıra LED'den oluşur. LED'lerin tümünün yanık olduğu bir durumda bu, ses seviyelerinizin çok yüksek olduğuna ve kırıldığına dair bir işarettir.

Ses seviye göstergelerinin davranışı, Audio Monitor Setup yardımcı yazılımında belirlediğiniz gösterge türü ayarına göre farklılıklar gösterecektir. VU ölçme çeşidini kullandığınızda, ses ekipmanınızdaki çıkış seviyelerini, seviyenin kontrol panelindeki 0dB göstergesinde pik yapacak şekilde ayarlayın. Bu, sinyal gürültü oranını (signal to noise ratio) en iyi seviyeye getirmenizi ve ses kalitesinin en yüksek kalitede olmasını sağlar. Ses kalitesinin 0dB göstergesinin üzerinde pik yapması halinde, ses bozulması için ciddi bir risk vardır.

Blackmagic Audio Monitor Setup'ın yüklenmesi ve seviye gösterge türlerinin ayarlanması hakkında bilgi için, 'Audio Monitor Kurulumu' bölümüne bakınız.

Solo Sol (Left) ve Solo Sağ (Right) Düğmeleri

Bu düğmeler sol ve sağ ses kanallarını izole etmenize yarar. Böylece, kanalların herhangi birindeki olası ses sorunlarını bağımsız olarak kontrol edebilirsiniz.

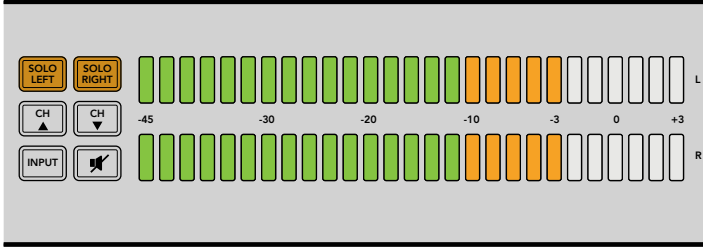

Solo Left (Solo Sol) düğmesinin seçilmesi sağ ses kanalının etkisiz hale getirilmesini sağlar. Ses seviye göstergesi, her iki seviyeyi göstermeye devam edecektir.

Sol ses kanalının denetlenmesi için:

- 1 Solo Left (Solo Sol) düğmesine basın. Bu düğme arkadan aydınlatmalı olarak yeşil renkte yanar ve ses yalnızca sol hoparlörden çıkar.
- 2 Stereo ses denetlemeye geri dönmek için Solo Left düğmesine tekrar basın.

Sağ ses kanalının denetlenmesi için:

- 1 Solo Right (Solo Sağ) düğmesine basın. Bu düğme arkadan aydınlatmalı olarak yeşil renkte yanar ve ses yalnızca sağ hoparlörden çıkar.
- 2 Stereo ses denetlemeye geri dönmek için Solo Right düğmesine tekrar basın.

Üstteki Kanal (Channel Up) ve Alttaki Kanal (Channel Down)

Bu düğmeler, SDI bağlantınızdaki gömülü ses kanalları arasında hareket etmenizi mümkün kılar. 3G-SDI için, bu;16 adede kadar kanalı veya 8 adede kadar kanal çiftini kapsar. Gömülü SDI ses kanalları arasında yukarı veya aşağı hareket etmek için, 'üstteki' (up) kanal veya 'alttaki' (down) kanal düğmelerine basın.

Blackmagic Audio Monitor 12G, 64 adede kadar ses kanalını veya 32 adede kadar kanal çiftini kapsayan, 12G-SDI'yi destekler. Bunlar arasında hızlı bir şekilde gezinmek için, yukarı veya aşağı ok düğmelerini basılı tutun.

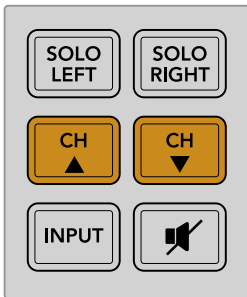

Giriş

INPUT (GİRİŞ) düğmesine tekrar tekrar basarak SDI, AES/EBU, Analog ve HiFi girişleri arasında gezinebilir ve denetlemek istediğiniz video ve ses ekipmanını seçebilirsiniz.

Seçilmiş olan ses girişini dahili hoparlörler ile dinleyebilmenin yanısıra, HDMI çıkışının 1. ve 2. kanallarındaki sesi denetleyebilirsiniz.

NOT HDMI çıkışı, analog, AES/EBU veya HiFi girişleri seçili olduğunda siyah video görüntüler. SDI Loop çıkışı daima SDI girişine bağlı olan videonun ve sesin çıkışını sağlar.

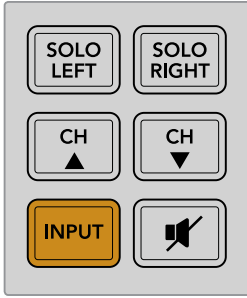

MUTE (Ses Kapatma)

Bu düğme, Blackmagic Audio Monitor'un kontrol paneli hoparlörlerinin ve kulaklıklarının sesini kapatır. Sesin kapatılması ses girişinizi etkilemeyecektir ve yalnızca hoparlörler ile kulaklıkların çıkışını etkileyecektir. MUTE düğmesine tekrar basıldığında, kontrol panelinin hoparlörlerine veya kulaklıklara ses tekrardan gelecektir. Ses seviyesinin artırılması da ayrıca sesin açılmasını sağlar.

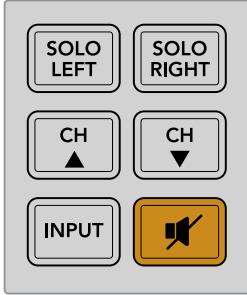

Ses Seviyesi

Bu düğme, hoparlörlerin ve kulaklıkların ses seviyesinin bağımsız olarak ayarlanmasına yarar. Ses Seviyesi dahili LCD ekranda görüntülenir. Kulaklıklar bağlı olduğunda, Blackmagic Audio Monitor'un hoparlörlerinin sesi kapanacaktır ve sesin çıkışı kulaklıklar aracılığıyla sağlanacaktır. Ses seviyesi, döndürmeli ses düğmesinin saat yönüne ya da saat yönünün aksine çevrilmesiyle kolaylıkla yukarı ya da aşağı ayarlanabilir.

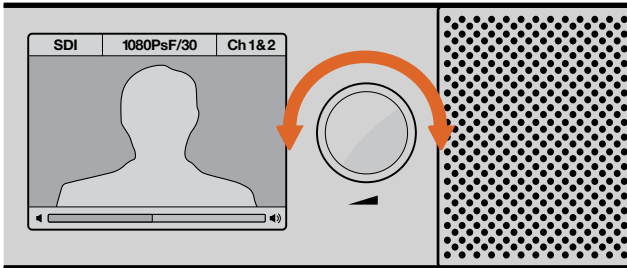

Ses seviyesi kontrol panelinin LCD ekranında görüntülenir.

Audio Monitor Kurulumu

Blackmagic Audio Monitor Kurulumu

Blackmagic Audio Monitor Setup yardımcı yazılımı, arzulanan ses seviye gösterge türünün ayarlanması için ve ayrıca Blackmagic Audio Monitor'daki dahili yazılımın güncellenmesi için kullanılır.

Kurulum yazılımı, gelen SD kartı ile yüklenebilir fakat, en son versiyonunu www.blackmagicdesign.com/tr/support adresindeki Blackmagic Design destek merkezinden indirmenizi tavsiye ediyoruz.

Orijinal Blackmagic Audio Monitor bir bilgisayara USB ile bağlandığında, kurulum yazılımını kullanarak yapılandırma ayarlarını değiştirebilir ve dahili yazılımı da güncelleyebilirsiniz. Blackmagic Audio Monitor 12G'de ayrıca Ethernet aracılığıyla üniteyi güncelleyebilir ve ayarları değiştirebilirsiniz. Lakin, ağ ayarlarının değiştirilmesi için bir USB'ye bağlı olmanız gerekecektir.

Blackmagic Audio Monitor Setup yazılımı, macOS Mojave 10.14 veya sonrası ve Windows 10 işletim sistemlerinde çalışır.

macOS Kurulumu

- 1 Yazılımı Blackmagic Design web sitesinden indirdiyse, gelen medyadan veya yüklenenler dosyasından yükleyici dosyasını çift tıklayın.
- 2 Yükleme talimatlarını takip edin ve MacOS, yazılımı otomatik olarak yükleyecektir.

Windows Kurulumu

- 1 Yazılımı Blackmagic Design web sitesinden indirdiyse, gelen medyadan veya yüklenenler dosyasından yükleyici dosyasını çift tıklayın.
- 2 Yükleme talimatlarını takip edin ve Lisans Sözleşmesindeki şartları kabul ettiğinizde, Windows otomatik olarak yazılımı yükleyecektir.

Dahili Yazılımın Güncellenmesi

- 1 Blackmagic Audio Monitor cihazınızı bir USB ya da Ethernet aracılığıyla bilgisayarınıza bağlayın.
- 2 Blackmagic Audio Monitor Setup'ı açın.
- 3 Configuration (yapılandırma) ikonunu tıkladığınızda yardımcı yazılım, bir güncellemeye gereksinim olup olmadığını gösterecektir.
- 4 Bir güncelleme gerekli olduğunda, 'update' düğmesini tıklayın ve yazılım yükleme işleminin tamamlanmasını bekleyin.



Dahili yazılım güncellemesini uygulamak için, Update (Güncelle) düğmesini tıklayın.



Bir ilerleme çubuğu güncellenizin durumunu görüntüleyecektir.

- 5 Güncelleme işlemi tamamlandıktan sonra 'close' (kapat) düğmesini tıklayın.



Blackmagic Audio Monitor'unuzun dahili yazılımını güncellemek ve yapılandırma ayarlarını değiştirmek için, Blackmagic Audio Monitor Setup yardımcı yazılımını kullanın.

Göstergeler Sekmesi

Kurulum yardımcı yazılımı açıkken, ses seviye gösterge ayarlarının görünmesi için yapılandırma ikonunu tıklayın. VU, PPM ya da EBU ile BBC ölçekleri olan ses seviye gösterge türleri arasından seçim yapabilirsiniz. VU göstergesi şimdi standart hale gelmişken, PPM ve ses seviye göstergeleri seçilmiş olan ses düzeyi için ölçeklendirme sistemleri ile ölçümler sağlarlar. Bir sonraki sayfada bulunan tabloda desteklenen ses seviye göstergeleri ile ölçek kombinasyonları verilmektedir.

Gösterge Türü	Ölçek Türü	Ölçüm Ölçeği	Kullanımı
VU	–	-45'ten +3'e	Birimin üzerinde basılıdır.
PPM	EBU	-12'den +12'ye	Yapıştırılmalı etiket
PPM	BBC	1'den 7'ye	Yapıştırılmalı etiket
Ses Düzeyi	EBU +9	-18'den +9'a	Yapıştırılmalı etiket
Ses Düzeyi	EBU +18	-36'dan +18'e	Yapıştırılmalı etiket
Ses Düzeyi	Tam Ölçek +9	-41'den -14'e	Yapıştırılmalı etiket
Ses Düzeyi	Tam Ölçek +18	-59'dan -5'e	Yapıştırılmalı etiket

VU

Bu gösterge, ses sinyalinizdeki kısa iniş ve çıkışları ortalar. Genellikle sinyaldeki piklerin denetlenmesinde kullanılır fakat, ortalama özelliğinden dolayı seçilmiş olan ses düzeyinin denetlenmesinde de kullanılabilir.

PPM

Bu gösterge, anlık olarak sinyallerin piklerini tutan ve yavaşça geri çekilmesini sağlayan bir 'pik tutma' özelliğini görüntüler. Böylelikle, sesin nerede pik yaptığını kolaylıkla görebilirsiniz.

Ses Düzeyi

Bu gösterge, ses sinyalinizdeki ses düzeyinin subjektif kalitesini görüntüler. Günümüz yayın standartları uyumlu ses seviyeleri için ses seviye ölçümleri de içeriyor.

VU ve PPM göstergeleri -18dB veya -20dB olarak seçilebilir bir referans seviyesi özelliğine sahiptir ve böylece farklı uluslararası yayın standartlarına uyacak şekilde sesi denetleyebilirsiniz.

Blackmagic Audio Monitor'un LED referans davranışı, seçilen her bir gösterge türü ile değişir. Sesin nerede pik yaptığını kolaylıkla belirleyebilmenize yardımcı olması amacıyla, tam doğru dB referans ölçeklerinin olduğu, yapıştırmalı etiketler Blackmagic Audio Monitor ile birlikte sağlanmıştır. Bu yapıştırmalı etiketleri yapıştırmak için, etiketi kağıdından ayırın ve istenilen ölçeği, renkli LED göstergeleri ile mevcut VU ölçek işaretleri arasına yapıştırın.

Her bir ses seviye gösterge türü ve ölçek için iki adet etiket mevcuttur. Etiketler ayrıca yerel Blackmagic Design destek ofisinden de temin edilebilir. Size yakın olan yerel destek ekibini bulmak için www.blackmagicdesign.com/support adresindeki Blackmagic Design destek merkezine bakınız.



Blackmagic Audio Monitor'unuzda görüntülemek üzere bir ölçüm ayarını seçmek için, dilediğiniz gösterge ayarı türünü tıklayın ve 'save' (kaydet) tıklayın.

EBU PPM									
-12	-8	-4	0	+4	+8	+12			
-12	-8	-4	0	+4	+8	+12			
BBC PPM									
1	2	3	4	5	6	7			
1	2	3	4	5	6	7			
Loudness Units EBU +9dB									
-18	-15	-12	-9	-6	-3	0	+3	+6	+9
-18	-15	-12	-9	-6	-3	0	+3	+6	+9
Loudness Units Fullscale +9dB									
-41	-38	-35	-32	-29	-26	-23	-20	-17	-14
-41	-38	-35	-32	-29	-26	-23	-20	-17	-14
Loudness Units EBU +18dB									
-36	-30	-24	-18	-12	-6	0	+6	+12	+18
-36	-30	-24	-18	-12	-6	0	+6	+12	+18
Loudness Units Fullscale +18dB									
-59	-53	-47	-41	-35	-29	-23	-17	-11	-5
-59	-53	-47	-41	-35	-29	-23	-17	-11	-5

Yapıştırmalı etiketler, her bir gösterge türü için sesin nerede pik yaptığını doğru olarak belirleyebilmeniz için size sağlanmıştır.

Configure (Yapılandırma) Sekmesi

Blackmagic Audio Monitor 12G, yazılım versiyon numarasını ve Blackmagic Audio Monitor'unuzun ağ ayarlarını içeren ilave bir 'configure' (yapılandırma) sekmesine sahiptir. Cihazınıza ayrıca özel bir isim de verebilirsiniz. Cihaza bir isim verilmesi, uzaktan bağlantılı olduğunda onun kolaylıkla tespit edilebilmesine yardımcı olur.

Blackmagic Audio Monitor 12G'ye isim verilmesi

Blackmagic Audio Monitor 12G'ye isim vermek için:

- 1 'configure' sekmesini tıklayın.
- 2 'details' (detaylar) ayarında 'name' (isim) yazı kutusunu tıklayın ve yeni etiket girin.
- 3 'Save' ibaresini tıklayın.



Ağ Ayarlarının Değiştirilmesi

Blackmagic Audio Monitor 12G'ye bir ağ üzerinden erişmek, birden fazla ünitenin idare edilmesinin en kolay yoludur. Bunu Blackmagic Audio Monitor Setup ile yapabilirsiniz. Varsayılan ayar olarak Blackmagic Audio Monitor 12G'niz otomatik olarak bir ağ adresi edinmeye yapılandırılmıştır. Böylelikle, kurulum yazılımının ana ekranından bunu hemen seçebilmeniz kolaylaştırılmıştır.

Bir Blackmagic Audio Monitor 12G'yi ağ üzerinde bulmakta sorun yaşıyorsanız ya da daha önce mevcut ağınız ile uyumlu olmayan bir statik adresi kullanmaya ayarladıysanız; ağ ayarlarını yerel olarak değiştirmeniz gerekebilir. Bunu USB ile yapabilirsiniz.

Ağ Ayarlarının USB aracılığıyla Değiştirilmesi

Ağ ayarlarınızı bir USB ile değiştirmek için, Blackmagic Audio Monitor 12G'nizi Blackmagic Audio Monitor Setup yazılımının olduğu bir bilgisayara bir USB ile bağlayın. Blackmagic Audio Monitor 12G'nin USB konektörünü arka panelinde bulabilirsiniz. Bağladıktan sonra, Audio Monitor 12G'nizi Blackmagic Audio Monitor Setup yardımcı yazılımının ana ekranından seçin ve 'configure' sekmesini bulun. Burada, dinamik ile statik ağ adresleri arasında gezinebilirsiniz. Bir statik IP seçtiğiniz takdirde; adresi, alt ağ maskesini ve ağ geçidini manuel olarak yapılandırabilirsiniz.

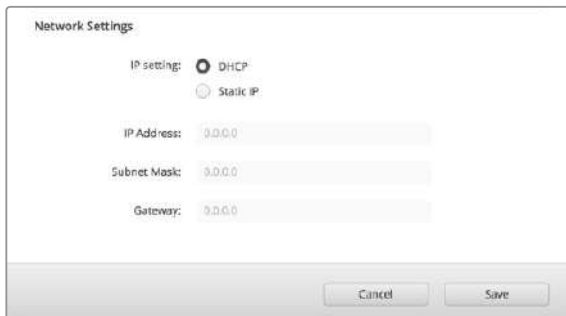

Opsiyonel Blackmagic Dolby® Kod Çözücü Modülünün Takılması

Dolby kod çözücü modülü artık Dolby tarafından üretimden kaldırılmıştır fakat, orijinal Blackmagic Audio Monitor için elinizde bu modül varsa ve takmak istiyorsanız, bu sayfadaki talimatları takip edin.

NOT Blackmagic Audio Monitor 12G, opsiyonel Dolby Kod Çözücü modülünü desteklemez.

UYARI

Kurulum işlemi, anakarta erişim için kasanın kapağının açılmasını gerektirdiğinden, Dolby kod çözücü modülünü takmadan önce, Blackmagic Audio Monitor'unuzun güç bağlantısının kesilmiş olduğundan emin olun. Bu işlem yalnızca yetkili kişiler tarafından yapılmalıdır. Modülün takılması esnasında elektrostatik boşalma riskini azaltmak için gerekli önlemlerin alınması gerekir.

Modülün Takılması

Blackmagic Dolby kod çözücü modülünü takarak, modern film ve televizyon yapımlarında kullanılan Dolby Dijital veya Dolby E sesi denetleyebilirsiniz. Dolby 5.1 çevresel (surround) ses; ön sağ ve sol kanalları, arka surround sağ ve sol kanalları, bir orta kanal ve ayrıca düşük bas frekansları için bir kanal ile kodlanmıştır.

Dolby kod çözücü bir 72 pin SIMM modüldür ve Blackmagic Audio Monitor'un anakartındaki boş SIMM yuvasına kolaylıkla yerleştirilebilir.

Opsiyonel Blackmagic Dolby® Kod Çözücü Ünitesinin Takılması:

- 1 Blackmagic Audio Monitor'un güç kaynağından bağlantısının kesilmiş olduğundan emin olun.
- 2 Blackmagic Audio Monitor'un kapağındaki 21 adet vidayı bir Phillips tornavida ile çıkarın. Kapağı çıkarın.
- 3 Blackmagic Dolby kod çözücüyü, bağlantıların boş SIMM yuvaya bakacak şekilde tutun. SIMM'in anahtarlarının olduğu yüzünün anahtar yuvası ile aynı hizada olması lazım aksi takdirde SIMM yerine oturmayacaktır.
- 4 Bağlantılar sıkıca oturana kadar modülü SIMM yuvasına yavaşça yerleştirin.
- 5 Metal klipler modülün her bir yanına sıkıca oturana kadar, üniteyi Blackmagic Audio Monitor'un arkasına doğru yaslayın.
- 6 Blackmagic Audio Monitor'un kapağını kapatın ve 21 adet vidayı takın.

Blackmagic Dolby kod çözücü modülünü taktıktan sonra, modül ile gelen Dolby sticker'ı Blackmagic Audio Monitor'un arka paneline, uyarı etiketine yakın bir yere yapıştırın. Böylece, Dolby modülünün takılmış olduğunu kolaylıkla görebilirsiniz.

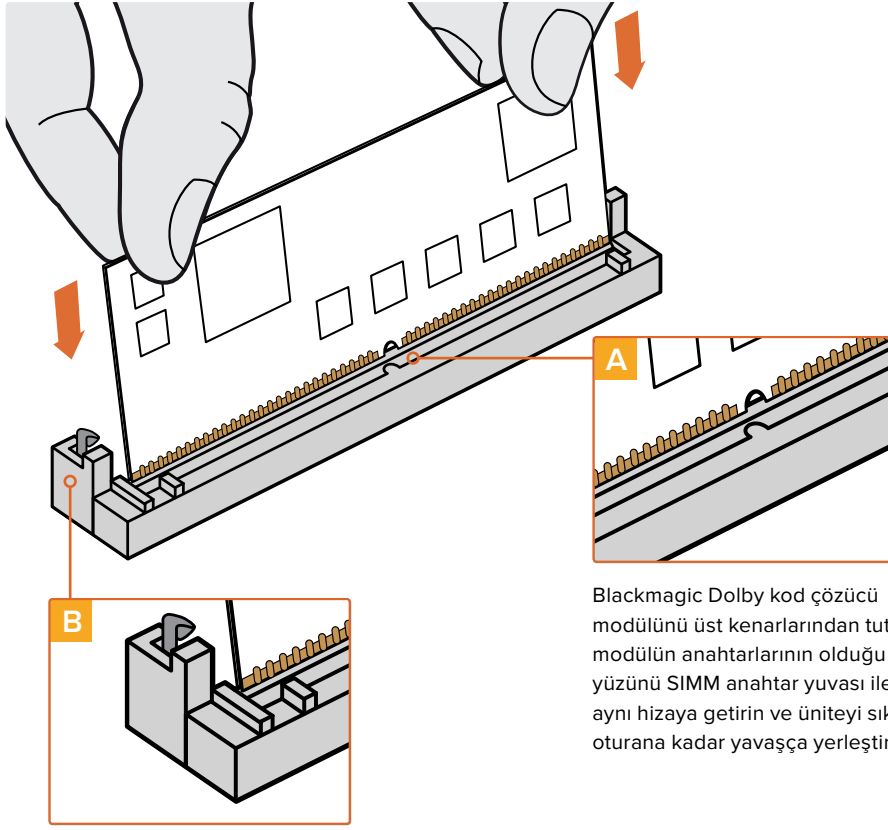

Blackmagic Dolby kod çözücü modülünü üst kenarlarından tutarak, modülün anahtarlarının olduğu yüzünü SIMM anahtar yuvası ile aynı hizaya getirin ve üniteyi sıkıca oturana kadar yavaşça yerleştirin.

Metal klipler ünitenin her bir yanına sıkıca oturana kadar, Blackmagic Dolby kod çözücüyü kasanın arkasına doğru yaslayın.

Dolby Sesin Teyit Edilmesi

Dolby kodlanmış ses, Blackmagic Audio Monitor tarafından tespit edildiğinde, Dolby logosu kontrol panelindeki LCD ekranının sağ üst köşesinde belirecektir. 4 çift Dolby surround ses kanalını, kontrol panelindeki yukarı ve aşağı düğmelerine basarak denetleyebilirsiniz.

Yazılım Geliştirici Bilgileri

Controlling Blackmagic Audio Monitor 12G using Telnet

The Blackmagic Audio Monitor 12G Ethernet Protocol gives you the freedom to build your own custom control solutions for your Blackmagic Audio Monitor 12G. For example, you can create your own software application or web interface to control your Blackmagic Audio Monitor 12G via Ethernet from your computer.

The first step is to connect your Blackmagic Audio Monitor 12G to your computer via Ethernet. You can do this by connecting to the same network your computer is connected to, or you can connect Blackmagic Audio Monitor 12G directly to your computer.

NOTE If Blackmagic Audio Monitor 12G is connected directly to your computer, set your computer to a manual static IP address. Set the first three blocks of numbers in the IP address to match your Blackmagic Audio Monitor 12G and set the subnet mask to 255.255.255.0. You can leave the gateway or router setting blank as it will not be used in a direct connection between your computer and Blackmagic Audio Monitor 12G.

If your network settings are set correctly, you can now open the Terminal application on macOS, or enable Telnet command line utilities on Windows and enter Blackmagic Audio Monitor 12G Ethernet Protocol commands. These commands can be programmed into your application and triggered by related items on a custom user interface of your own design.

Using Telnet on macOS and Windows

- 1 On macOS, open the Terminal application which is located within the Applications > Utilities folder.
To open the command prompt in Windows, click on the 'start' menu and type 'cmd' in the search bar. Press 'enter'.
- 2 Type in "telnet" and a space followed by the IP address of your computer, then another space and "9996", which is the default port number for Blackmagic Audio Monitor 12G.
For example:

```
telnet 192.168.25.253 9996
```

Press 'enter'. The Protocol Preamble screen will appear.

Blackmagic Audio Monitor 12G Ethernet Protocol V1.0

Summary

The Blackmagic Audio Monitor 12G Ethernet Protocol is a text based protocol that is accessed by connecting to TCP port 9996 on a Blackmagic Audio Monitor 12G.

The Blackmagic Audio Monitor 12G sends information in blocks which each have an identifying header in all-caps, followed by a full-colon. A block spans multiple lines and is terminated by a blank line.

Each line in the protocol is terminated by a new line character.

Upon connection, the Blackmagic Audio Monitor 12G sends a complete dump of the state of the device. After the initial status dump, status updates are sent every time the Blackmagic Audio Monitor 12G status changes.

To be resilient to future protocol changes, clients should ignore blocks they do not recognize, up to the trailing blank line. Within existing blocks, clients should ignore lines they do not recognize.

Legend

↵ line feed or carriage return
... and so on

Version 1.0 of the Blackmagic Audio Monitor 12G Ethernet Protocol was released with Blackmagic Audio Monitor 12G 3.0 software.

Protocol Preamble

The first block sent by the Blackmagic Audio Monitor 12G is always the protocol preamble:

```
PROTOCOL PREAMBLE:  
Version: 1.0
```

The version field indicates the protocol version. When the protocol is changed in a compatible way, the minor version number will be updated. If incompatible changes are made, the major version number will be updated.

Device Information

The next block contains general information about the connected Blackmagic Audio Monitor 12G device. If a device is connected, the Blackmagic Audio Monitor 12G will report the attributes of the Blackmagic Audio Monitor 12G:

```
AUDIOMONITOR DEVICE:↵  
Model: Blackmagic Audio Monitor 12G  
Label: Blackmagic Audio Monitor 12G
```

Only the label can be modified.

```
AUDIOMONITOR DEVICE:↵  
Label: My new name↵  
↵
```

The response will be

```
ACK:  
AUDIOMONITOR DEVICE:  
Label: My new name
```

The next block will show the network settings which can only be changed via the Blackmagic Audio Monitor Setup utility when connected over USB. This is for information only.

```
NETWORK:  
Dynamic IP: 1  
Current address: 0.0.0.0  
Current subnet: 0.0.0.0  
Current gateway: 0.0.0.0
```

The next block is the meter type.

```
AUDIO METER:  
Meter Mode: VU (-20dBFS Ref)
```

This can be changed to VU (-20dBFS Ref), VU (-18dBFS Ref), PPM EBU (-20dBFS Ref), PPM EBU (-18dBFS Ref), PPM BBC (-20dBFS Ref), PPM BBC (-18dBFS Ref), Loudness (EBU +9 scale) or Loudness (EBU +18 scale)

```
AUDIO METER:↵  
Meter Mode: Loudness (EBU +18 scale)↵  
↵
```

The response will be

```
ACK:  
AUDIO METER:  
Meter Mode: Loudness (EBU +18 scale)
```

The next block is the input type.

```
AUDIO INPUT:  
Routing: Speaker Stereo SDI Stereo 1-2
```

This can be changed to SDI Stereo 3-4, SDI Stereo 5-6, SDI Stereo 7-8, SDI Stereo 9-10, SDI Stereo 11-12, SDI Stereo 13-14, SDI Stereo 15-16, XLR AES/EBU Stereo 1-2, XLR Analog Stereo or RCA Stereo

```
AUDIO INPUT:↵  
Routing: Speaker Stereo XLR AES/EBU Stereo 1-2↵  
↵
```

The response will be

```
ACK:  
AUDIO INPUT:  
Routing: Speaker Stereo XLR AES/EBU Stereo 1-2
```

The next block is the audio output state. This indicates the current headphone and speaker volume settings as well as the state of the mute and solo buttons.

```
AUDIO OUTPUT:  
Gain: Speaker Stereo 0  
Gain: Headphone Stereo 0  
Mute: false  
Solo: Off
```

The volume gain settings can be set between 0 and 255. Mute can be true or false and Solo can be Off, Left or Right

```
AUDIO OUTPUT:↵  
Gain: Speaker Stereo 125↵  
Solo: Right↵  
↵
```

The response will be

```
ACK:  
AUDIO OUTPUT:  
Gain: Speaker Stereo 125  
Solo: Right
```

Checking the Connection

While the connection to the Blackmagic Audio Monitor 12G is established, a client may send a special no-operation command to check that the Blackmagic Audio Monitor 12G is still responding:

```
PING:↵  
↵
```

If the Blackmagic Audio Monitor 12G is responding, it will respond with an ACK message as for any other recognized command.

Checking valid Protocol Commands

While the connection to the Blackmagic Audio Monitor 12G is established, a client may send a special HELP command to obtain a list of supported Telnet commands:

```
HELP:↵  
↵  
AUDIOMONITOR DEVICE:  
Model: <label> [read only]  
Label: <label>  
Unique ID: <label> [read only]  
  
NETWORK:  
Dynamic IP: <boolean> [read only]  
Current address: <IP_address> [read only]  
Current subnet: <IP_address> [read only]  
Current gateway: <IP_address> [read only]  
  
AUDIO METER:  
Meter Mode: <enum> -> <enum> = <"VU (-20dBFS Ref)" | "VU (-18dBFS Ref)" |  
"PPM EBU (-20dBFS Ref)" | "PPM EBU (-18dBFS Ref)" | "PPM BBC (-20dBFS Ref)"  
| "PPM BBC (-18dBFS Ref)" | "Loudness (EBU +9 scale)" | "Loudness (EBU  
+18 scale)">;  
  
AUDIO INPUT:  
Routing: <enum1> <enum2> -> <enum1> = <"Speaker Stereo">; <enum2> = <"SDI  
Stereo 1-2" | "SDI Stereo 3-4" | "SDI Stereo 5-6" | "SDI Stereo 7-8" | "SDI  
Stereo 9-10" | "SDI Stereo 11-12" | "SDI Stereo 13-14" | "SDI Stereo 15-16" |  
"XLR AES/EBU Stereo 1-2" | "XLR Analog Stereo" | "RCA Stereo">;  
  
AUDIO OUTPUT:  
Gain: <enum> <integer> -> <enum> = <"Speaker Stereo" | "Headphone Stereo">;  
<integer> = <0..255>;  
  
Mute: <boolean> -> <boolean> = <true | false>;  
  
Solo: <enum> -> <enum> = <"Off" | "Left" | "Right">;
```

Yardım

Yardım İin

Yardım almanın en hızlı yolu Blackmagic Design online destek sayfalarına girip Blackmagic Audio Monitor'unuz için mevcut olan en son destek malzemesini incelemenizdir.

Blackmagic Design Online Destek Sayfaları

En son kılavuz, yazılım ve destek notlarına www.blackmagicdesign.com/tr/support adresindeki Blackmagic Design destek merkezinden ulaşılabilir.

Blackmagic Design Forum

Web sitemizdeki Blackmagic Design forum, daha fazla bilgi ve yaratıcı fikirler için ziyaret edebileceğiniz faydalı bir kaynaktır. Burası yardım alabilmeniz için daha hızlı bir yol olabilir çünkü, başka deneyimli kullanıcılar ya da Blackmagic Design çalışanları tarafından sorularınıza yanıtlar bulabilir ve bu sayede çalışmalarınıza devam edebilirsiniz. Foruma <https://forum.blackmagicdesign.com> adresinden ulaşabilirsiniz.

Blackmagic Design Destek Hizmetiyle İrtibat

Aradığınız yardımı, destek kaynaklarında ya da forumda bulamadığınızda, lütfen destek sayfamıza girerek "Bize e-posta gönderin" butonunu tıklayarak e-posta yoluyla destek talebinde bulunun. Bunun yerine, destek sayfasındaki "Yerel destek ekibini arayın" butonunu tıklayıp size en yakın olan Blackmagic Design destek ofisini arayabilirsiniz.

Mevcut Yazılım Sürümünün Kontrol Edilmesi

Bilgisayarınızda Blackmagic Audio Monitor Setup yazılımının hangi sürümünün yüklü olduğunu kontrol etmek için, About Blackmagic Audio Monitor Setup penceresini açın.

- MacOS sistemlerinde, 'Uygulamalar' klasöründen Blackmagic Audio Monitor Setup yazılımını açın. Sürüm numarasını görüntülemek için, uygulama menüsünden 'About Blackmagic Audio Monitor Setup' ibaresini seçin.
- Windows 10 sistemlerinde, 'Başlangı' sayfasındaki Blackmagic Audio Monitor Setup başlığından, Blackmagic Audio Monitor Setup yazılımını açın. Sürüm numarasını görüntülemek için 'Yardım' menüsünü tıklayın ve 'About Blackmagic Audio Monitor Setup' ibaresini seçin.

En Son Yazılım Güncellemelerine Erişim

Bilgisayarınızda yüklü bulunan Blackmagic Audio Monitor Kurulum yazılımının sürümünü kontrol ettikten sonra, lütfen Blackmagic Design destek merkezine www.blackmagicdesign.com/tr/support adresinden girerek en son güncellemeleri gözden geçirin. En son güncellemeleri çalıştırmak faydalı olsa da önemli bir projenin ortasındaiken, yazılımı güncellemekten kaçınmakta yarar vardır.

Mevzuata İlişkin Bildirimler

Avrupa Birliği Dahilinde Elektrikli ve Elektronik Ekipman Atıklarının Bertaraf Edilmesi.



Ürün üzerindeki sembol, bu ekipmanın başka atık malzemelerle bertaraf edilmemesi şartını belirler. Atık ekipmanlarınızı bertaraf edebilmemiz için, geri dönüşümünü sağlamak üzere, belirlenmiş toplama noktasına teslim edilmeleri gerekmektedir. Bertaraf anında atık cihazlarınızın ayrı olarak toplanması ve geri dönüşümü, doğal kaynakların korunmasına yardımcı olacaktır ve insan sağlığını ve çevreyi koruyucu bir şekilde geri dönüşümünü sağlayacaktır. Atık ekipmanlarınızı geri dönüşüm için nereye teslim edebileceğiniz konusunda daha fazla bilgi için, lütfen yerel belediyenizin geri dönüşüm şubesini ya da ürünü satın aldığınız satış bayisini arayınız.



Bu cihaz, test edilmiş ve Federal İletişim Komisyonu (FCC) koşullarının 15. bölümü doğrultusunda A Sınıfı dijital cihazların sınırlarıyla uyumlu olduğu tespit edilmiştir. İlgili sınırlar, bu cihaz ticari bir ortamda çalıştırıldığında, zararlı müdahalelere karşı makul koruma sağlaması amacıyla tasarlanmıştır. Bu ekipman, radyo frekans enerjisi üretir, kullanır ve saçabilir ve talimatlar doğrultusunda kurulmadığı ve kullanılmadığı takdirde, radyo iletişimlerine zararlı müdahaleye yol açabilir. Bu ürünün bir yerleşim bölgesinde çalıştırılması zararlı müdahaleye yol açabilir. Bu durumda, müdahalenin düzeltilmesi için ilgili maliyeti kullanıcı karşılamak zorundadır.

Bu cihazın çalıştırılması aşağıdaki iki şarta bağlıdır:

- 1 Bu cihaz, zararlı müdahaleye sebebiyet vermemelidir.
- 2 Bu cihaz, arzu edilmeyen bir çalışma şekline yol açacak müdahaleler de dahil olmak üzere, maruz kaldığı her türlü müdahaleyi, kabul etmelidir.

ISED Kanada Beyannamesi

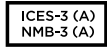

Bu cihaz, A Sınıfı dijital cihazlar için Kanada standartlarıyla uyumludur.

Bu cihaza yapılacak herhangi bir değişiklik veya kullanım amacı dışında kullanılması, bu standartlara uyumluluğunu hükümsüz kılabilir.

HDMI arayüzlerine bağlantı, yüksek kaliteli korumalı HDMI kablolarıyla yapılmalıdır.

Bu cihaz, ticari ortamda kullanım amacına uygunluk için test edilmiştir. Bu cihaz bir ev ortamında kullanıldığı durumlarda, radyo parazitine neden olabilir.

Güvenlik Bilgileri

Elektrik çarpmalarına karşı korunmak için, bu cihaz koruyucu topraklama bağlantısı olan bir şebeke prizine takılmalıdır. Şüpheli durumlarda yetkili bir elektrikçi ile irtibata geçiniz.

Elektrik çarpması riskini azaltmak için, bu cihaz damlayan veya sıçrayan suya maruz bırakılmamalıdır.

Bu ürün çevresel ısısı 40° C'ye kadar olan tropikal ortamlarda kullanılmaya uygundur.

Cihazın çevresinde yeterli havalandırma olduğundan ve hava akımının kısıtlanmadığından emin olun.

Rafa monte ederken, bitişik cihazlardan dolayı hava akımının kısıtlanmadığından emin olun.

Ürünün içinde, kullanıcı tarafından tamir edebilecek hiçbir parça bulunmamaktadır. Gerekli tamiratları yerel Blackmagic Design servis merkezine yönlendirin.



Deniz seviyesinden yüksekliğin 2000m'yi aşmadığı yerlerde kullanın.

Kaliforniya Eyaleti Beyannamesi

Bu ürün; plastik parçaları dahilinde, eser miktarda polibromine bifeniller gibi kimyasal maddelere sizi maruz bırakabilir. Kaliforniya eyaletinde, bu maddelerin kansere, doğum kusurlarına veya başka üreme bozukluklarına sebebiyet verdiği bilinmektedir.

Daha fazla bilgi için www.P65Warnings.ca.gov adresini ziyaret ediniz.

GARANTİ

12 Ay Sınırlı Garanti

Blackmagic Design şirketi bu ürünün satın alındığı tarihten itibaren malzeme ve işçilik bakımından 12 ay boyunca arızasız olacağına garanti sunmaktadır. Üründe bu garanti süresi içinde bir arıza ve kusur söz konusu olursa Blackmagic Design, kendi seçimi doğrultusunda, ya arızalı ürünü parça ve işçilik bedeli talep etmeksizin tamir edecektir ya da arızalı ürünü, yenisiyle değiştirecektir.

Bu garanti kapsamında hizmetten yararlanmak için, siz müşterilerin, Blackmagic Design'i garanti süresi sona ermeden arızaya ilişkin bilgilendirmeniz ve söz konusu hizmetin sağlanması için uygun düzenlemeleri yapmanız gereklidir. Blackmagic Design tarafından özel belirlenmiş ve yetkilendirilmiş bir hizmet merkezine, arızalı ürünün ambalajlanarak sevkiyatı, Müşterilerimizin sorumluluğudur ve sevkiyat ücretleri peşin ödenmiş olmalıdır. Herhangi bir sebepten dolayı bize iade edilen ürünlerin; tüm nakliye, sigorta, yasal bedel, vergi ve diğer tüm masrafların ödenmesi müşterinin sorumluluğu altındadır.

Bu garanti; yanlış kullanım ya da yanlış veya kusurlu bakımdan kaynaklanan herhangi bir arızayı, bozukluğu ya da hasarı kapsamaz. Blackmagic Design burada açıklanan durumlarda, bu garanti kapsamında hizmet sağlamak zorunda değildir: a) Blackmagic Design temsilcileri haricindeki başka personelin ürünü kurma, tamir etme ya da bakımını yapma girişimlerinden kaynaklanan hasarın tamir edilmesi, b) uygun olmayan kullanım veya uyumlu olmayan ekipmanlara bağlanmasından kaynaklanan hasarın tamir edilmesi, c) Blackmagic Design parçaları ya da malzemesi olmayan ürünlerin kullanımından kaynaklanan hasarın ya da arızanın tamir edilmesi ya da d) Modifiye veya başka ürünlerle entegre edilmiş bir ürünün; söz konusu modifikasyon ya da entegrasyonun gereken tamiratın süresini uzattığı ya da ürün bakımını zorlaştırdığı durumlarda, tamir edilmesi. BU GARANTİ, BLACKMAGIC DESIGN TARAFINDAN VERİLMİŞTİR VE AÇIK YA DA ZİMNİ, HERHANGİ BİR GARANTİNİN YERİNİ TUTAR. BLACKMAGIC DESIGN VE SATICILARI, TİCARİ GARANTİ YA DA ÖZEL BİR AMACA UYGUNLUK GARANTİSİNİ KABUL ETMEZ. BLACKMAGIC DESIGN'İN HATALI ÜRÜNLERİ TAMİR ETME YA DA DEĞİŞTİRME SORUMLULUĞU, BLACKMAGIC DESIGN YA DA SATICILARININ SÖZ KONUSU HATA HAKKINDA ÖNCEDEN BİLGİSİ OLMASINI GÖZETMEKSİZİN, ÜRÜNDE DOLAYLI, ÖZEL, DOĞRUDAN YA DA SONUÇ NİTELİĞİNDE ORTAYA ÇIKAN HERHANGİ BİR HASAR İÇİN MÜŞTERİYE SUNACAĞI TAM VE MÜNHASİR ÇÖZÜMDÜR. BLACKMAGIC DESIGN, EKİPMANIN MÜŞTERİLER TARAFINDAN YASAL OLMAYAN HERHANGİ BİR KULLANIMINDAN SORUMLU DEĞİLDİR. BLACKMAGIC DESIGN, BU ÜRÜNÜN KULLANIMINDAN KAYNAKLANAN HERHANGİ BİR HASARDAN SORUMLU DEĞİLDİR. BU ÜRÜNÜN ÇALIŞTIRILMASINDAN DOĞAN RISK, KULLANICININ KENDİSİNE AİTTİR.

© Telif Hakkı Saklıdır 2020 Blackmagic Design. Tüm Hakları Saklıdır. 'Blackmagic Design', 'DeckLink', 'HDLink', 'Workgroup Videohub', 'Multibridge Pro', 'Multibridge Extreme', 'Intensity' ve 'Leading the creative video revolution', ABD ve diğer ülkelerde tescil edilmiş ticari markalardır. Diğer tüm şirket ve ürün isimleri bağlantılı oldukları ilgili şirketler/firmaların ticari markaları olabilir.