

# NOTES

MATERIAL MOLDED USING GENERAL PURPOSE ABS PLASTIC

PARTS COMES WITH SELF TAPPING, OVAL HEAD TYPE, #4 X 0.625" SCREWS, REPLACEMENT PART NUMBER 1593MS100 - PACKAGE OF 100.

COLOR CHOICE OF BLACK OR GRAY.

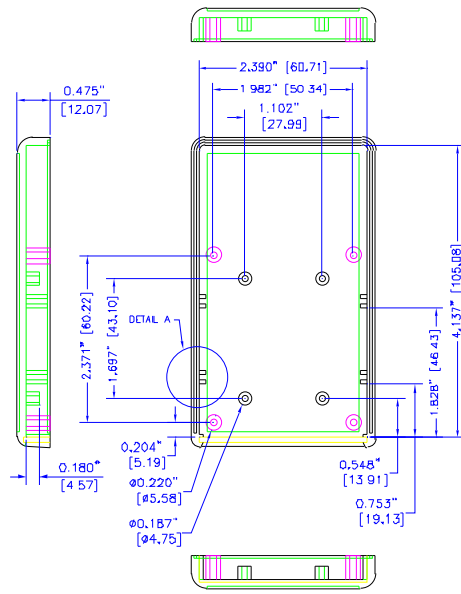

TOP HALF

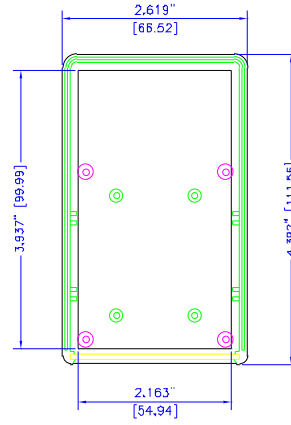

APPROX 1 DEGREE DRAFT ANGLE

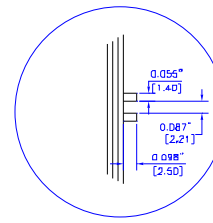

DETAIL A

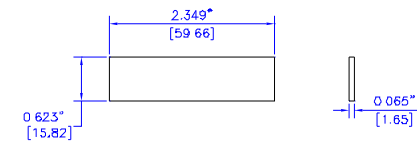

FRONT PANEL

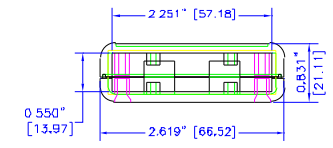

ASSEMBLED VIEW

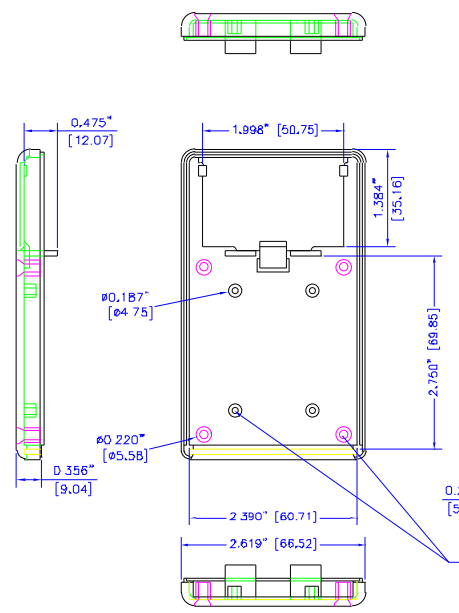

BOTTOM HALF

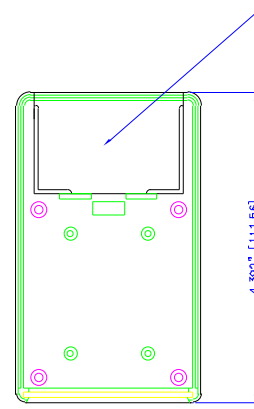

APPROX 1 DEGREE DRAFT ANGLE

UNLESS OTHERWISE SPECIFIED DIMENSIONS ARE IN INCHES

X +/- .1

XX +/- .05

XXX +/- .015

CUTS +/- .005

ANGLES +/- .5 DEG.

NOTICE

HAMMOND CLAIMS PROPRIETARY RIGHTS TO THE MATERIAL ON THIS DRAWING. IT IS INTENDED TO BE USED AS A REFERENCE FOR ENGINEERING INFORMATION ONLY. THIS INFORMATION MAY NOT BE USED TO MANUFACTURE PRODUCTS WITHOUT WRITTEN PERMISSION FROM HAMMOND MANUFACTURING.

**HAMMOND MANUFACTURING**

WEB: [WWW.HAMMONDMFG.COM](http://WWW.HAMMONDMFG.COM)

TITLE		HAMMOND 1593 SERIES INSTRUMENT ENCLOSURE	
DRAWN BY	MJM	DATE	11/14/00
SCALE		PAGE	1 OF 1
PART NUMBER	1593T		