

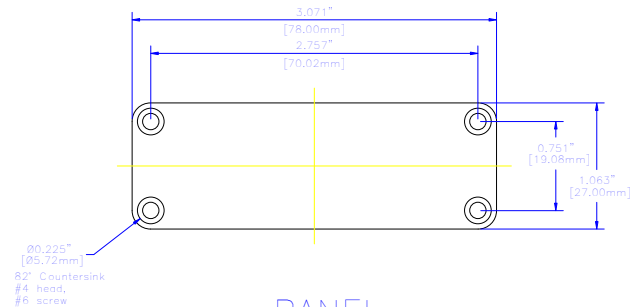

NOTES

Constructed from extruded Al with a minimum thickness of 0.060" (1.50mm)  
 Available in clear or Black anodized finish  
 Version 1 includes two Al end panels, and two Black plastic bezels.  
 Hardware and self-adhesive rubber feet included.

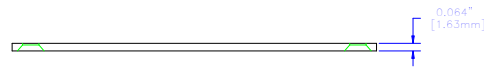
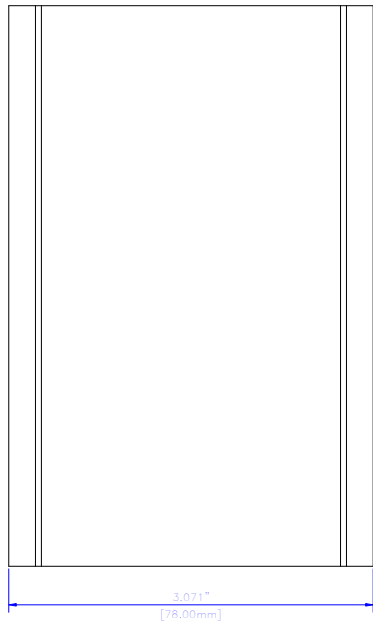

PANEL

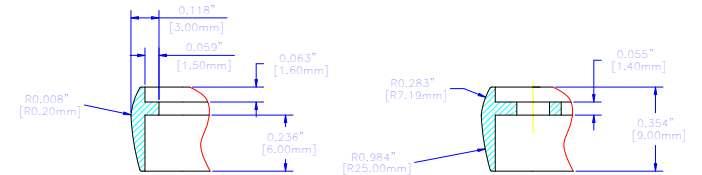

SECTION A-A  
SCALE 2:1

SECTION B-B  
SCALE 2:1

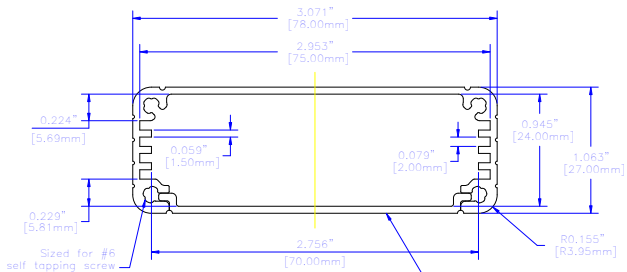

Sized for #6 self tapping screw

Base Plate is removable.

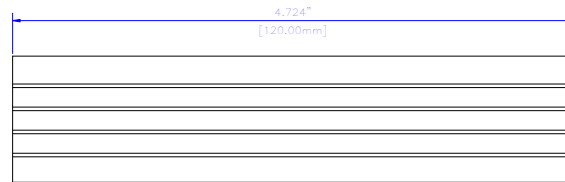

EXTRUSION

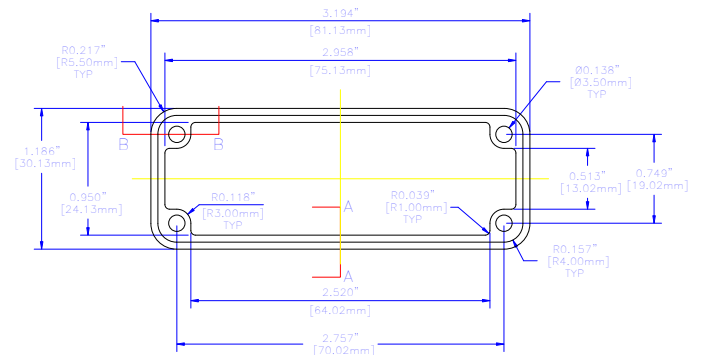

BEZEL

For the best fit print on legal size paper.

THIS DRAWING IS PROPRIETARY INFORMATION OF HAMMOND MFG.CO.LTD. NOT TO BE USED WITHOUT EXPRESSED WRITTEN PERMISSION OF HAMMOND MFG.CO.LTD.

Rev.	EC	Description	Date	By

Unless otherwise specified dimensions are in inches  
 Tolerances are:

.X	± .1
.XX	± .02
.XXX	± .010
.XXXX	± .0005
Holes	± .0050
Angles	± .5°

Dwn	T. SPARKS
Date	04 11 02
Chk	---
Mat'l	Extruded Aluminum

HAMMOND MANUFACTURING CO. LTD.  
 Electronics Group, Waterloo, Ont. - Cheektowaga, NY

HAMMOND 1455 SERIES  
 EXTRUDED ALUMINUM

Sheet 1 of 2

Part # 1455J1201

Dwg: 1455J1201/A

NOTES

Constructed from extruded Al with a minimum thickness of 0.060"(1.50mm)  
 Available in clear or Black anodized finish  
 Version 1 includes two Al end panels, and two Black plastic bezels.  
 Hardware and self-adhesive rubber feet included.

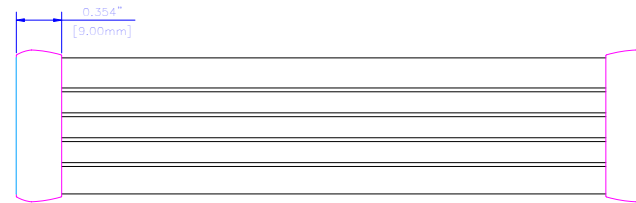
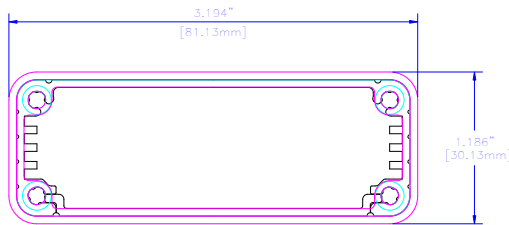
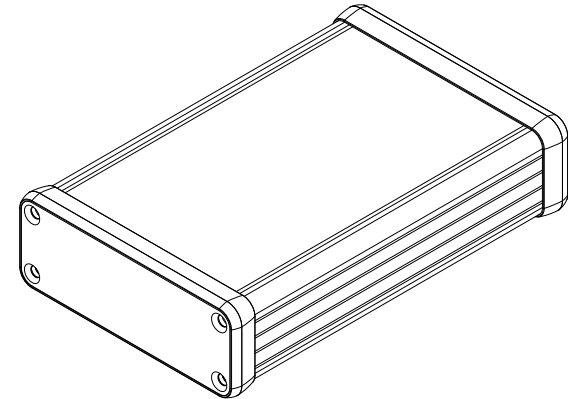
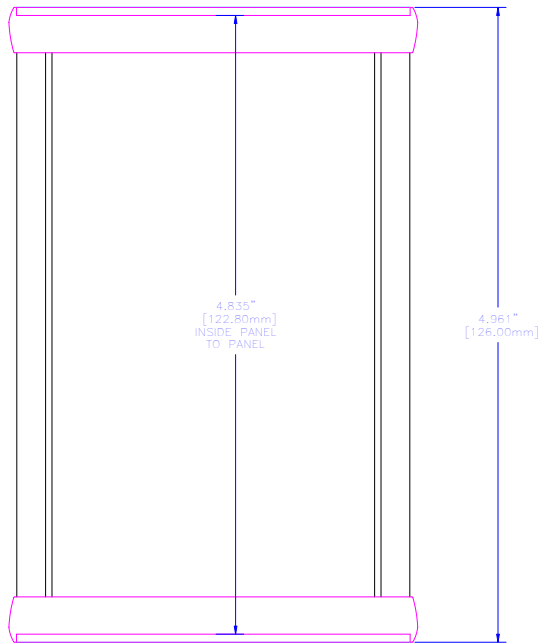

For the best fit print on legal size paper.

ASSEMBLED

THIS DRAWING IS PROPRIETARY INFORMATION OF HAMMOND MFG.CO.LTD. NOT TO BE USED WITHOUT EXPRESSED WRITTEN PERMISSION OF HAMMOND MFG.CO.LTD.

Rev	EC	Description	Date	By

Unless otherwise specified dimensions are in inches  
 Tolerances are:  
 .X ± .1  
 .XX ± .02  
 .XXX ± .010  
 .XXXX ± .0050  
 Holes ± .005  
 Angles ± .5°



Dwn	T. SPARKS
Date	04 11 02
Chk	---
Mat'l	Extruded Aluminum
Sheet	2 of 2

**HAMMOND MANUFACTURING CO. LTD.**  
 Electronics Group, Waterloo, Ont. - Cheektowaga, NY

**HAMMOND 1455 SERIES  
 EXTRUDED ALUMINUM**

Part #: 1455J1201 Dwg: 1455J1201/A