

NOTES

FOR MORE DETAILED INFORMATION GO TO THE HAMMOND WEB SITE

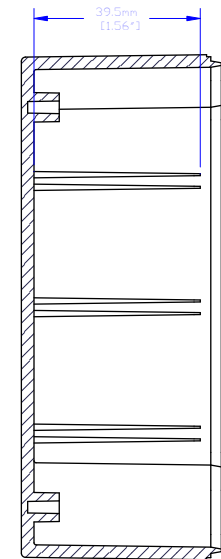

SECTION D-D
SCALE 1 : 1

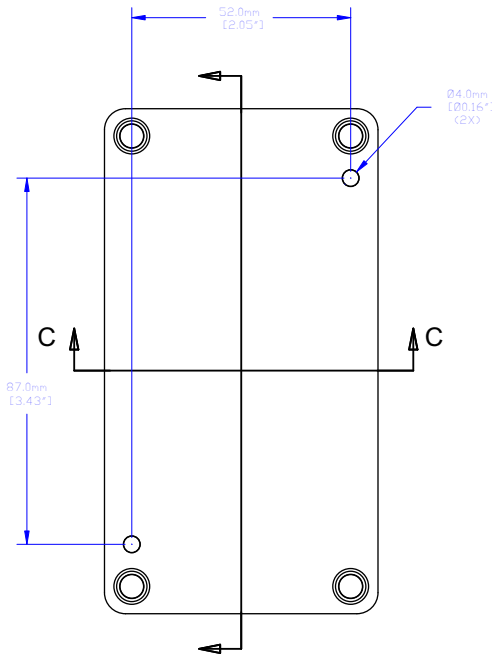
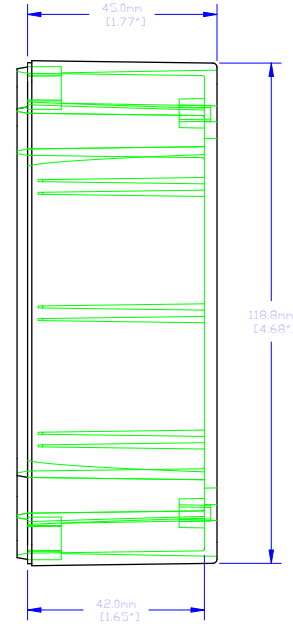
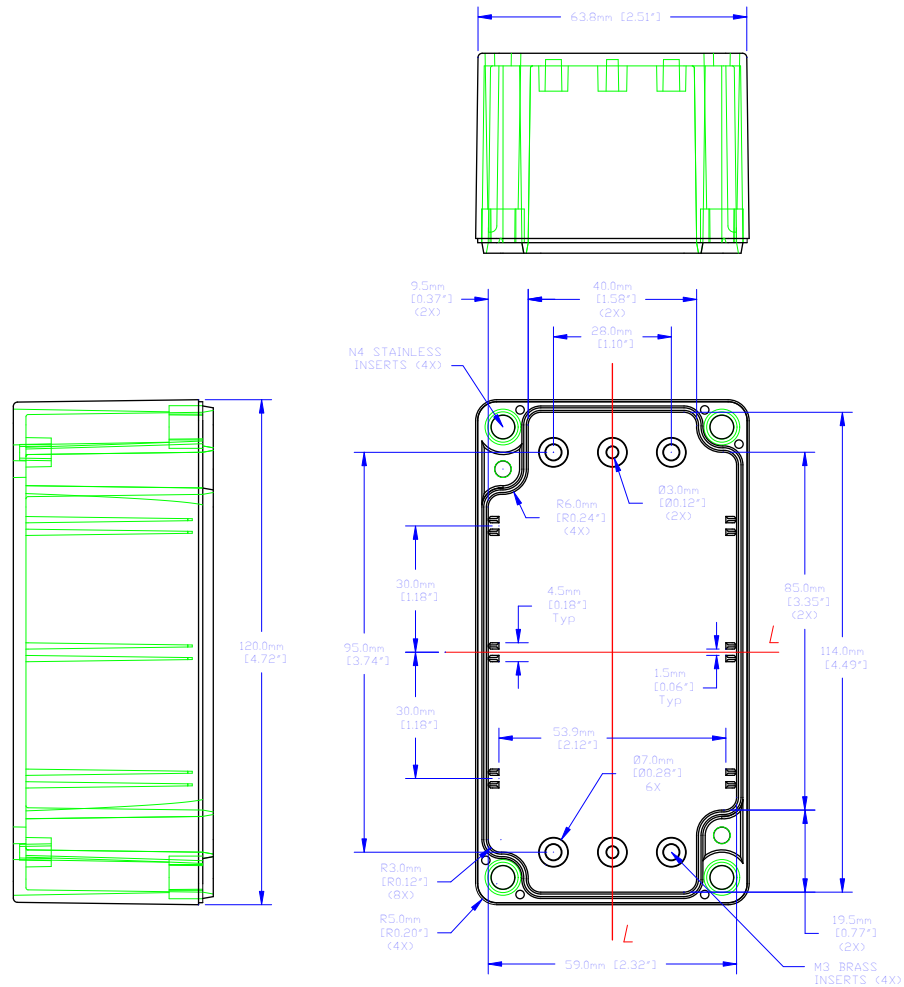
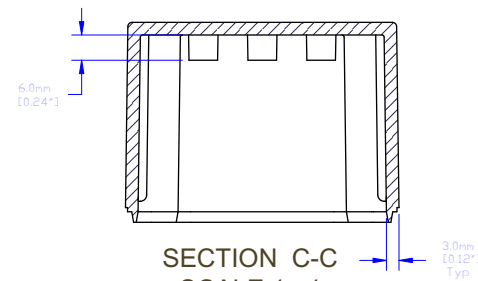

SECTION C-C
SCALE 1 : 1

For the best fit print on legal size paper.

 HAMMOND MANUFACTURING CO., LTD.
Electronics Group, Waterloo, Ont. - Cheektowaga, NY

VISIT US ON THE WORLD WIDE WEB: WWW.HAMMONDMFG.COM

THIS DRAWING IS PROPRIETARY INFORMATION OF HAMMOND MFG.CO.LTD. NOT TO BE USED WITHOUT EXPRESSED WRITTEN PERMISSION OF HAMMOND MFG.CO.LTD.

Dwg Rev. # -



Mat1 ABS PLASTIC OR POLYCARBONATE

Sheet 1 of 1

HAMMOND 1554 SERIES

Part#: 1554D

Dwg: 1554D-BOX

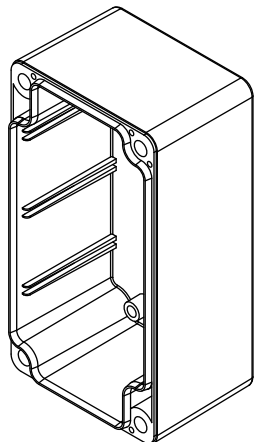

NOTES

FOR MORE DETAILED INFORMATION GO TO THE HAMMOND WEB SITE

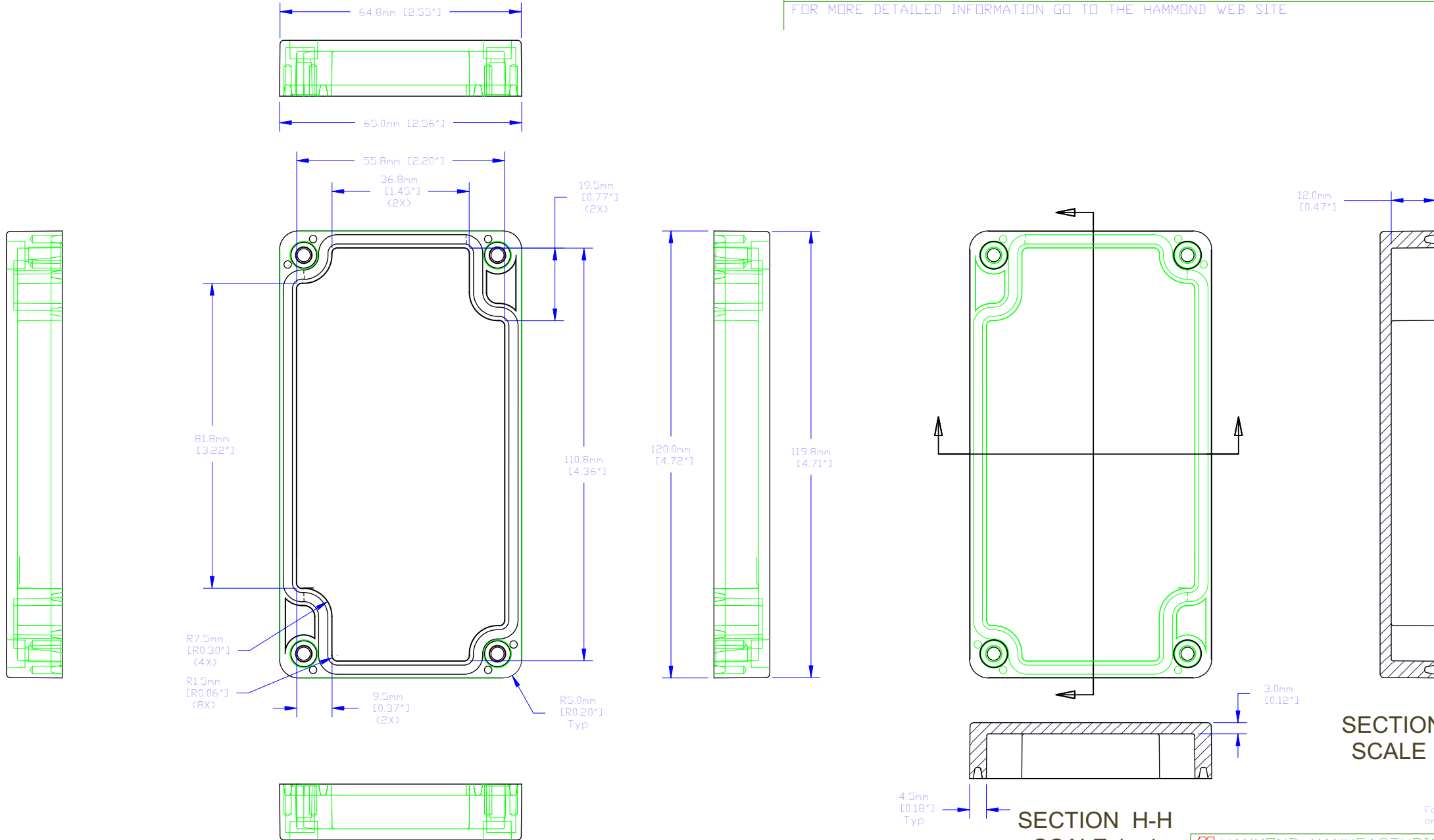

SECTION J-J
SCALE 1 : 1

SECTION H-H
SCALE 1 : 1

For the best fit print on legal size paper.

VISIT US ON THE WORLD WIDE WEB: WWW.HAMMONDMFG.COM

 HAMMOND MANUFACTURING CO. LTD.
Electronics Group, Waterloo, Ont. - Cheektowaga, NY

THIS DRAWING IS PROPRIETARY INFORMATION OF HAMMOND MFG.CO.LTD. NOT TO BE USED WITHOUT EXPRESSED WRITTEN PERMISSION OF HAMMOND MFG.CO.LTD.

Dwg Rev. # -

Mat'l ABS PLASTIC OR POLYCARBONATE
Sheet 2 0 4

HAMMOND 1554 SERIES

Part#: 1554D

Dwg: 1554D-LID

NOTES

FOR MORE DETAILED INFORMATION GO TO THE HAMMOND WEB SITE

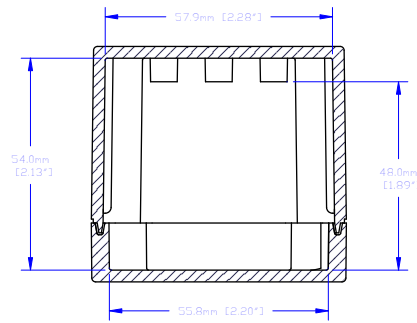
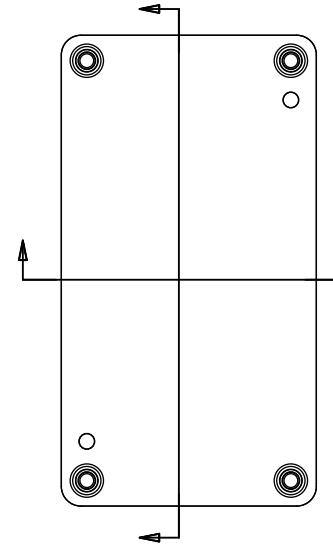
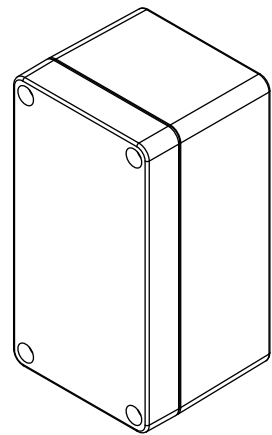
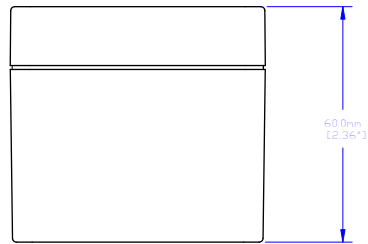
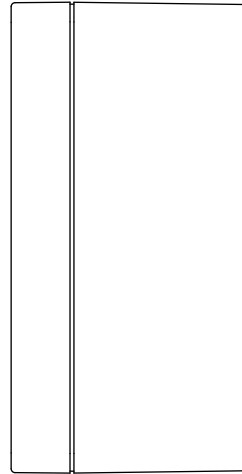
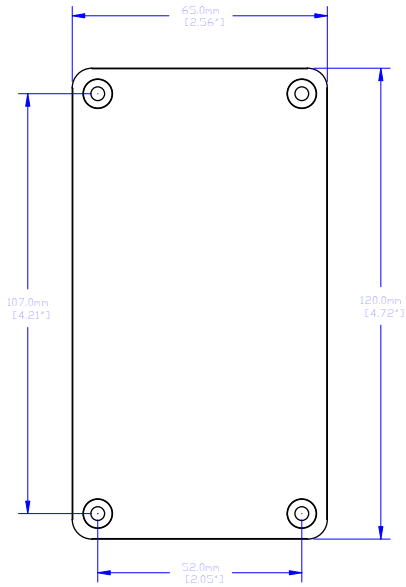
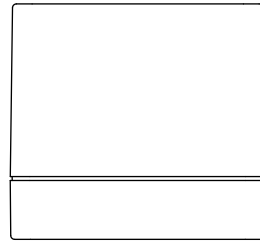

SECTION F-F
SCALE 1 : 1

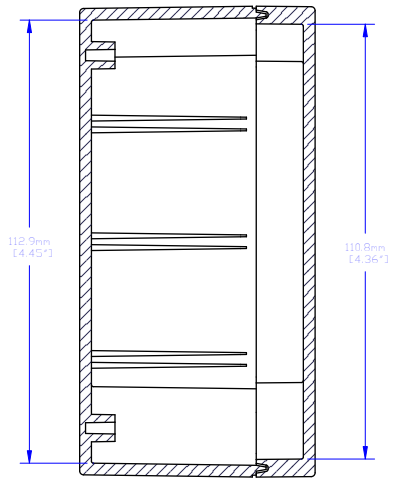

SECTION G-G
SCALE 1 : 1

For the best fit print on legal size paper.

 HAMMOND MANUFACTURING CO. LTD.
Electronics Group, Waterloo, Ont. - Cheektowaga, NY

VISIT US ON THE WORLD WIDE WEB: WWW.HAMMONDMFG.COM

THIS DRAWING IS PROPRIETARY INFORMATION OF HAMMOND MFG.CO.LTD. NOT TO BE USED WITHOUT EXPRESSED WRITTEN PERMISSION OF HAMMOND MFG.CO.LTD.

Dwg Rev. #	-	Mat'l	ABS PLASTIC OR POLYCARBONATE
		Sheet	3 of 4

HAMMOND 1554 SERIES

Part#: 1554D Dwg: 1554D-ASSEM

NOTES

FOR MORE DETAILED INFORMATION GO TO THE HAMMOND WEB SITE

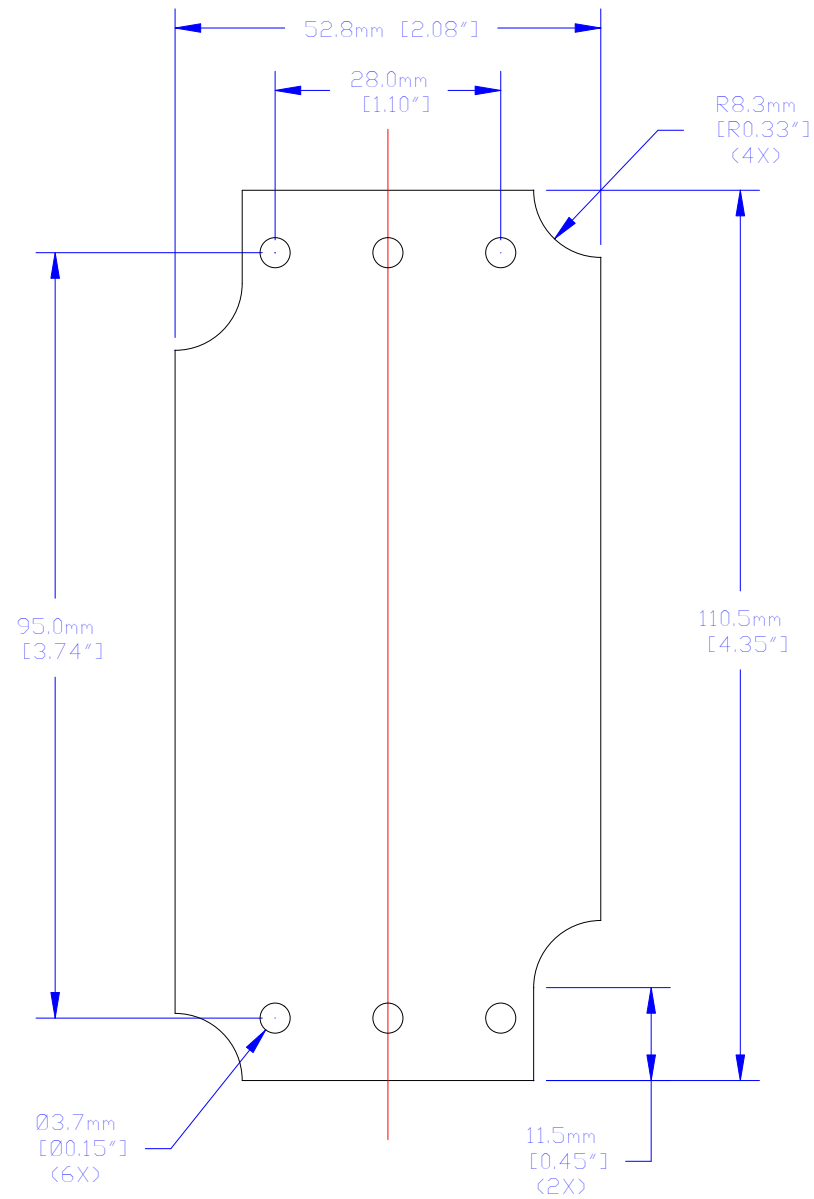

For the best fit print on legal size paper.

 HAMMOND MANUFACTURING CO. LTD.
Electronics Group, Waterloo, Ont. - Cheektowaga, NY

VISIT US ON THE WORLD WIDE WEB: WWW.HAMMONDMFG.COM

THIS DRAWING IS PROPRIETARY INFORMATION OF HAMMOND MFG.CO.LTD. NOT TO BE USED WITHOUT EXPRESSED WRITTEN PERMISSION OF HAMMOND MFG.CO.LTD.

Dwg Rev. # - Mat'l 14 GA. GALV-STEEL



Sheet 1 0 1

HAMMOND 1554 SERIES

Part#: 1554CPL

Dwg: 1554D-PANEL